

MasterCraft



Supplement to the
2014 Owner's Manual

ProStar



ProStar

Welcome aboard!

Many years of ownership enjoyment are ahead for boat owners who carefully review and follow the guidance provided in the Owners Manual that accompanied delivery of your boat. In addition to the detailed information provided in that publication, this supplemental guide offers some model-specific information pertaining to your ProStar boat.

Please take a few minutes to review all the material supplied. The information has been developed to ensure optimum enjoyment and safe operation, as well as providing the proper maintenance for years of boating enjoyment.

If you are unsure about any aspect of your boat or its operation, please discuss your concerns and questions with an authorized MasterCraft dealer before operating the boat.

ProStar

| | |
|------------------------------|----------------------------------|
| Length of Boat..... | 20' |
| Width Amidship..... | 96" |
| Boat Weight | 3,000 lbs. |
| Length of Boat w/Platform .. | 22'2" |
| Towing Length | 25'10" |
| Towing Width | 99" |
| Fuel Capacity | 25 gallons |
| Maximum Capacity | |
| | 7 people or 1,341 lbs. (650 kg.) |
|Bow: | 2 people or 300 lbs. |

Storage space is located under:

Observer's seat, bow seating, aft and wrap-around seating, port and starboard sun pads.

- 1 = Bow hatch (where equipped)
- 2 = Drop-in walk-thru door
- 3 = Folding walk-thru seat
- 4 = Storage compartment
- 5 = Circuit breaker panel, including battery ON-OFF switch (side panel, walk-thru)
- 6 = Adjustable mirror
- 7 = Bilge thru-hull outlet
- 8 = Navigation light
- 9 = Instrument panel (details follow)
- 10 = Bow cleat (where equipped)
- 11 = Steering wheel
- 12 = Shift-throttle control
- 13 = Fire suppression unit manual override
- 14 = In-floor storage compartment
- 15 = Engine compartment
- 16 = Aft seating (where equipped)
- 17 = Fuel tank filler
- 18 = Stern cleat (where equipped)
- 19 = Aft storage compartment
- 20 = Transom drain plug (center beneath swim platform)
- 21 = Transom rail with tow eye (where equipped)
- 22 = Engine exhaust (two below swim platform)
- 23 = Swim platform
- 24 = Aft storage compartment
- 25 = Battery (beneath storage door)
- 26 = Stern cleat (where equipped)
- 27 = Stern light receptacle (if equipped with tower, the light will be in center aft of tower)
- 28 = Aft seating (where equipped)
- 29 = Automatic fire extinguisher (inside engine compartment)
- 30 = Center drain plug (inside engine compartment on deck floor)
- 31 = Ski pylon
- 32 = Amp (where equipped, beneath observer seat)
- 33 = Hand-held fire extinguishers (beneath observer seat)
- 34 = Bow cleat (where equipped)
- 35 = MTS Ballast System (where equipped, beneath observer seat)
- 36 = Navigation light
- 37 = Glovebox
- 38 = iPod interface (where equipped, inside glovebox)
- 39 = Stereo CD Player (inside glove box, where equipped)
- 40 = Sirius Satellite Radio (where equipped)
- 41 = Heater (where equipped)
- 42 = Bow seating (where equipped)

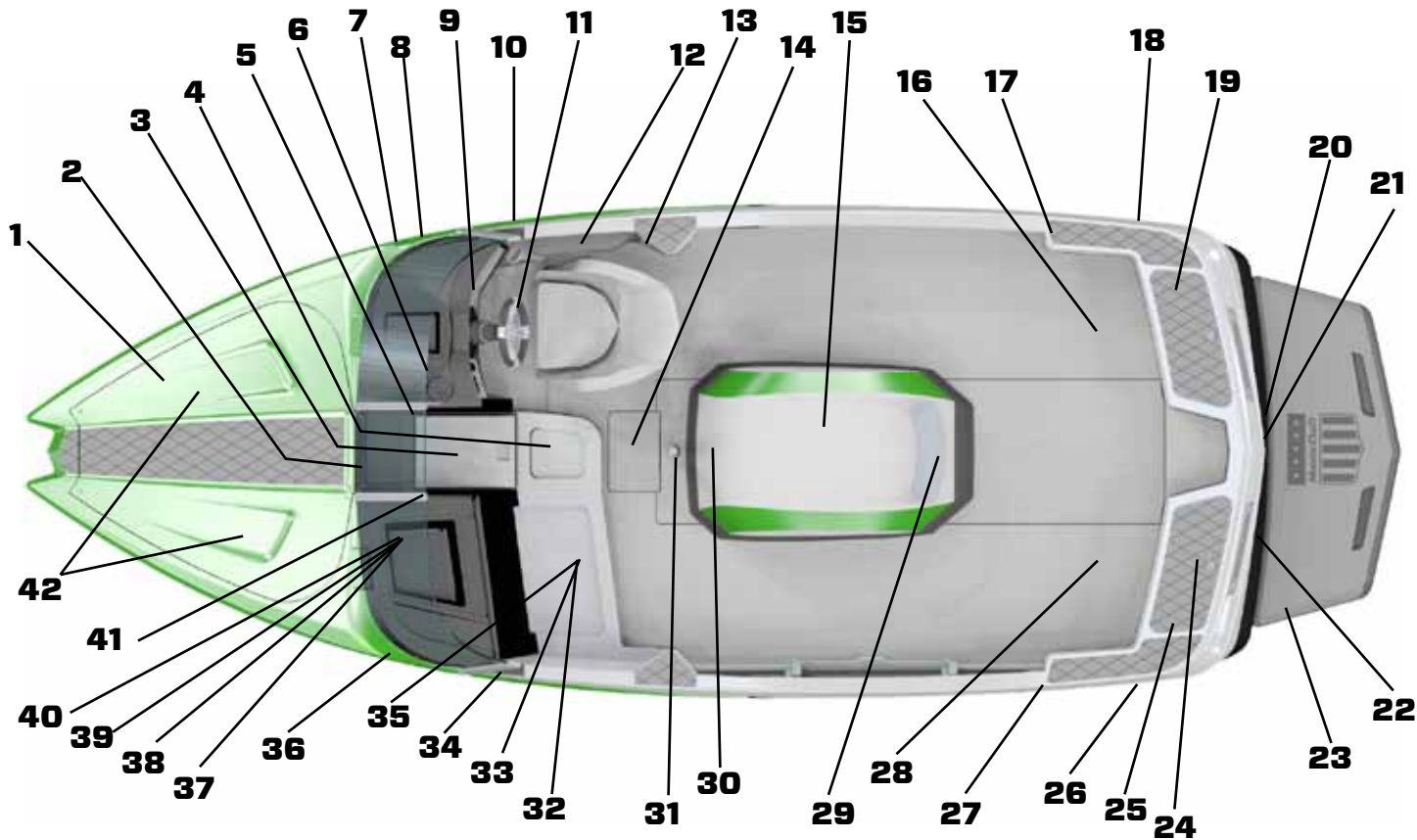

ProStar Video Screen Operations

7" Screen



The ProStar 7" video touch screen is a multi-functional tool that provides GPS tracking, multi-media display, cruise control, rider profiles, and enables equipment operators to view a wide range of engine, ballast, transmission parameters and service codes.

Care and Maintenance

Only basic cleaning should be required to maintain the 7" video touch screen at its best. A soft cloth can be used for cleaning the units. Typical window cleaner or rubbing alcohol can also be used to clean the glass portion of the video screen display. Do not use harsh or abrasive cleaners on the unit.

CAUTION

Avoid contact between sharp or hard objects and the video touch screen because this can result in scratches or other permanent marks on the screen. Clean only with a soft cloth, using window cleaner or rubbing alcohol only. Never use harsh or abrasive cleaners on the unit, as this may result in damage to the unit that is not covered under warranty.

Basic Navigation Features

All features are easily accessible through the quick access keys, touch point commands and menus.

Quick Access Keys

The following controls are accessed via the Quick Access Keys: Audio, Ballast/Trim, Gauges, Video, Settings Menu, GPS, User Profiles, Cruise ON/OFF, Increase Value and Decrease Value. They are called Quick Access Keys because a new screen can be called up quite fast by pressing the key.

Touch Point Commands

After the desired screen is accessed, navigation within the screen is controlled with Touch Point Commands. These are executed by touching the screen in areas that are outlined with a highlighted bezel.

In addition, there are areas where sliding a finger up or down can adjust settings. For example, on the Ballast and Tabs screen, sliding the finger on the screen on the inside of the tank area adjusts the ballast setting.



There are also areas in which sliding a finger from side to side will scroll through a list.

When the slider bar on top of the screen is visible, sliding the finger across it will change screens.

NOTE: While the slide area may appear to be curved, it is, in fact, a straight line.

Audio

The Audio screen can be accessed by pressing the Quick Access Key. Press any Quick Access Key to exit this screen.



The stereo display and functionality is supported by JL Audio Media Master. Please see the JL owner's manual.



Ballast and Trim

The Ballast and Trim screen can be accessed by pressing the Quick Access Key. Press any Quick Access Key to exit this screen.



This screen displays the current state of



the ballasts and trim tabs. Refer to the information following for actions using the Touch Commands on this screen.

Touch Commands Function and Description



Touch to turn cruise control OFF or ON.



Touch to stop all activity on this screen.



Touch to turn AUTO LAUNCH/EXIT ON or OFF. When Auto Launch is on, it automatically controls the center tab. When speed is above the Auto Launch speed the center tab will be retracted to 0% or if a profile is selected, it deploys the center tab to the profile setting. If the speed is above the Auto Launch speed and then decelerated below the Auto Launch speed, the tab deploys to 100.



Touch to save the settings to the current rider profile.

NOTE: If no rider profile is selected, does nothing.



Touch to save these settings to a new rider profile. A keyboard is displayed to

name the new profile and the new profile process is launched. *(See Profiles for more information.)*



Touch to fill all ballasts.



Touch to empty all ballasts.



Touch and slide your finger to the desired Ballast Tank level, or touch the UP DOWN Arrows to obtain the level.

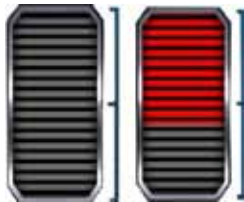

Touch and slide your finger to the desired

Trim Tab position.

Gauges

The Gauges screen can be accessed by pressing the Quick Access Key. Press any Quick Access Key to exit this screen.



Gauge Screen Gage Display

- Speedometer (MPH)
- Water Depth (FT)
- Air Temperature (F°)
- Water Temperature (F°)
- Battery Voltage (Volts)
- Engine Run Time (Hours)



Touch Commands

Description



Touch to turn cruise control ON or OFF.

Video

The Video screen can be accessed by pressing the Quick Access Key. Press any Quick Access Key to exit this screen.



Touch Commands

Description



Touch to turn cruise control ON or OFF.



Touch to view the Tower video source.
Press the Video Quick Access Key to go back.



Touch to view the Aux Video source.
Press the Video Quick Access Key to go back.



Touch to view the Media video source.
Press the Video Quick Access Key to go back.

Heater and Lights

The Heater and Lights screen can be accessed by pressing the Quick Access Key. Press any Quick Access Key to exit this screen.



Touch Commands

Description



Touch to turn cruise control ON or OFF.



Touch to turn ON or OFF.



Touch again to choose a High or Low temperature setting.



Touch to turn ON or OFF.

Profiles

The Profiles screen can be accessed by pressing the Quick Access Key.



This feature displays rider/user profiles for cruise controls based on user preferences for Set Speed, Ballast, and Tab settings. Up to 16 rider/user profiles can be created and stored.

To scroll through the available Profiles, slide finger across the information slide bar or press the Quick Access Keys and to view the list.

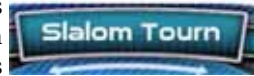

Touch Commands

Description



Touch to turn cruise control ON or OFF.



Touch to delete the selected rider after confirmation warning.



Touch to activate the user displayed in that event with all settings activated.



Touch to edit existing user or event name.

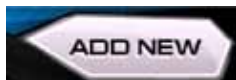

Touch to add a new rider. See the process in the next section.

A new rider profile can be setup using the touch screen. To create a new profile, press the **[Profile]** Quick Access Key:



Touch **[ADD NEW]** to create a new profile.



Type a name for the new profile using the touch keypad and touch **[DONE]**.



Touch **[NEXT]** to continue.



Touch the **[UP]** or the **[DOWN]** arrow to Set the speed for this profile.

Touch **[Change]** to set 3 Event Type.
Touch **[Next]** to continue.



Set the tab by either sliding the finger down the ridged area or by touching the **[UP]** and **[DOWN]** arrows. Touch **[NEXT]** to continue.



Touch to highlight the Pull Type; touch the arrows to change the setting.



Touch to highlight the Wait Time; touch the arrows to change the setting.



Final Save profile or edit screen. Review the Profile settings. Touch [SAVE] to save the profile and return to the Profiles screen with the new profile displayed.



Touch the Toggle +/- to set ON or OFF.



Set the ballast tanks by touching and sliding the finger up the tank area or by touching the [UP] and [DOWN] arrows alongside the tank area. Touch [NEXT] to continue.



New rider activates Screen with New name listed above the Activate button. Touch [ACTIVATE] to activate the settings for this profile.



On the 3 Event Screen, everything is activated.

Delete Current Profile



Touch **[DELETE]** to delete the current profile. A confirmation overlay is displayed. Touch **[CANCEL]** to abort the process and **[YES]** to confirm delete.

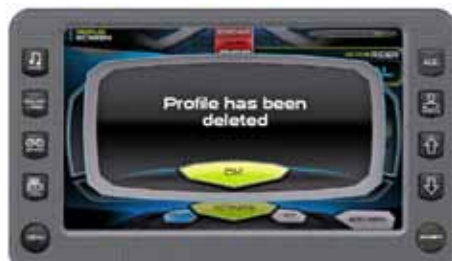

Touch **[OK]** to return to the Profiles screen. Now the Profile screen has no rider profile.

Edit Current User



Touch **[EDIT]** to modify the user profile. Touch **[EDIT]** to retype the name, touch **[NEXT]** to continue or **[CANCEL]** to return to the Profiles Screen.

Follow the same steps as creating a new profile touch **[NEXT]** to continue to the next screen without change. Remember to click the Save on the final screen to save the changes.

Tournament Events

The 3 Event screen can be accessed by pressing the Quick Access Key. This feature provides a way to keep a boat within the strict guidelines of the event it is tracking and provide a visual display of the track and the progress of the skier.



Tournament and Training Modes

There are two modes for the 3-Event feature, Tournament and Training. On the 3-Event Screen touch [Change Event] to access the pop-up list.

Tournament Mode

Slalom Tournament
Jump Tournament
Trick

Training Mode

Slalom Training
Jump Training



The Tournament Mode is limited to the set speed of the event.

The Training Mode operates like the Tournament Mode without the set speed limitation.



Slalom Screen— Tournament or Training



The screen illustrates the display available when the event being tracked is the Slalom event; the three-event feature is turned on and is in tournament mode. The

Touch Commands aid in setting up, controlling and tracking the Slalom event.

Touch Commands

Description



Cruise - Touch to turn cruise control ON or OFF. (or press the Quick Access Key from this screen.)



Settings - Select to set the Buzzer Volume, Prop Type, Timing Recap, and Slalom wait time. See Slalom Tournament Settings.



Save New - Select to setup a new rider profile. See *Profiles*.



Change Event - Touch to select an event from a list.



Course Manager - Allows you to map a course. See *Course Manager*.



Pull Type - Touch to select a pull type from a list.



Plus-Factor - Touch to select ON or OFF from the pop-up. This setting is for additional throttle when entering the first gate.



Event Times - Display the event times as the skier passes the mapped points. (Touch

the numbers to view the previously recorded times; **Timing Recap**.)

Slalom Settings— Tournament or Training

On the 3 Event Screen, touch the Settings touch command to access the pop-up. Touch each option to view or change the setting. When available, touch the arrows to change the setting.



Touch **[Settings]**. On the Pop-up, touch the arrows to change the Slalom Wait Time.



Touch **[Settings]**. Touch **[Buzzer Volume]**. On the Pop-up, touch the arrows to turn Buzzer Volume **UP** or **DOWN**.

Touch **[Exit]** to return to close the pop-up.



Touch **[Exit]** to return to close the pop-up. Touch **[Settings]**. Touch **[Prop Type]**. On the Pop-up, touch to change from 3 blade or 4 blade.



Touch **[Settings]**. Touch **[Timing Recap]**. The pop-up displays current and previous event times.

Course Manager— All Slalom and Jumping Events

On the 3 Event screen, touch the **[Course Manager]** in the bottom of the screen to start mapping a course.





Touch the arrows to select a course that is not mapped. Touch **[Map Course]**.

NOTE: Additional Details on Course List: The blue lettering above the course list displays the mapped information for the course selected. Always highlight a course on the list page before mapping a new course. When mapping a course, the program assigns the mapping to whatever name is highlights on the course list. For example, if Course1 was previously mapped and is highlighted when a new course is mapped, the new mapping will overwrite the original.

Touch the arrows to select a course type: Jump, Slalom 4-Buoy or Slalom 8-Buoy. Touch **[Continue]**.



Allow the program time to load.



Press the **[Start Gate]** to begin Mapping.

NOTE: For Slalom, press the **[Start Gate]** button when the GPS puck crosses the start gate.

For Jump, press the **[Start Gate]** button when the ski pylon crosses the start gate.

If necessary, touch **[Cancel]** to cancel the current mapping and return to the course list.



Press the **[End Gate]** to complete Mapping.



Course Mapping Successful will appear on the screen.



Type the name of the course. Touch **[Done]**. This saved your changes.



The new name is highlighted. Touch **[Done]**.

NOTE: Additional Options on the Course List pop-up.

- **Auto Detect** – Touch to select **ON** or **OFF**.

Auto Detect ON–the display automatically selects the nearest mapped course, based on the longitude/latitude that is the same

event type the user is in (slalom or jump).

Auto Detect OFF–The user must select a course before running it.

- **Edit Name** – Touch to go back and edit a previously saved course.
- **Map Course** – Touch to map another course.
- **Exit** – touch to return to the 3 Event screen.
- **List of Courses** - Touch **UP** and **DOWN** arrows to scroll the list and choose a course.

Jump Screen– Tournament or Training

The screen illustrates the display available when the event is Jump Tournament; the three-event features are in tournament mode and ready for settings. Use the Touch Commands in setting up, controlling and tracking the Jump event.



Touch Commands Description



Cruise - Touch to turn cruise control **ON** or **OFF**. (or press the Quick Access Key from this screen.)



Settings – Select to set the Buzzer Volume, Prop Type, Timing Recap, and Jump Switch Timeout.



Save New – Select to setup a new rider profile. See *Profiles*.



Change Event – Touch to select an event from a list.





Course Manager – Allows you to map a course. See *Course Manager*.



Jump Letter –Touch to select a Jump Letter, Weight, and Distance using the arrows to change the values. Touch **[Accept]** to save or **[Cancel]** to close pop-up.



RTB - Touch to select **ON** or **OFF** from the pop-up.



Event Times - Display the event times as the skier passes the mapped points. (Touch the numbers to view the previously recorded times; *Timing Recap*.)

Jump Settings— Tournament or Training

On the 3 Event Screen, touch the Settings touch command to access the pop-up list. Touch each option to view or change the setting. When available, touch the arrows to change the setting. Touch **[Exit]** to close the pop-up.



Touch **[Settings]**. Touch **[Buzzer Volume]**. On the Pop-up, touch the arrows to set a value at high speed and low speed.



Touch **[Settings]**. Touch **[Prop Type]**. On the Pop-up, touch to set at 3 blade or 4 blade.



Touch **[Settings]**. Touch **[Timing Recap]**. The pop-up displays current and previous event times.



Touch **[Settings]**. Touch **[Jump Switch Timeout]**. On the Pop-up, touch the arrows to change the value.

NOTE: ZeroOff recommends keeping the default value of 1.8, (only changing in extreme conditions).

Trick Screen

The screen illustrates the display available when the event is Trick Tournament; the three-event features are in tournament mode and ready for settings. Use the Touch Commands in setting up, controlling and tracking the Trick event.



Touch Commands Description



Cruise - Touch to turn cruise control **ON** or **OFF** (or press the Quick Access Key from this screen.)



Settings – Select to set the Buzzer Volume, Prop Type, and River Mode.



Save New – Select to setup a new rider profile. See *Profiles*.



Change Event – Touch to select an event from a list.





Course Manager – Allows you to map a course. See *Course Manager*.



Pull Type – Touch to select a Pull Type on the pop-up.



Plus-Factor - Touch to select **ON** or **OFF** from the pop-up. In the ON position, the system will react sooner to both increase and decrease in speed deviation. Used for trick setting or additional throttle when entering the first gate.

Trick Settings- Tournament or Training

On the 3 Event Screen, touch the Settings touch command to access the pop-up list. Touch each option to view or change the setting. When available, touch the arrows to change the setting. Touch **[Exit]** to close the pop-up.



Touch **[Settings]**. Touch **[Buzzer Volume]**. On the Pop-up, touch the arrows to set a value at high speed and low speed.



Touch **[Settings]**. Touch **[Prop Type]**. On the Pop-up, touch to set at 3 blade or 4 blade.



Touch **[Settings]**. Touch **[River Mode]** to select **ON** or **OFF**. With **River Mode ON**, touch to set the **River Dir Offset UP** and **DOWN** values using the arrows.



Settings Menu

The Settings Menu screen can be accessed by pressing the Quick Access Key. The following settings are available:



Touch Commands Description



User Settings – Allows you to customize the display options for ambient light and brightness, set US or metric units Tab, Ballast, and other settings.



Service Information – Provides information about the software version, dealer, oil changes and dealer services.

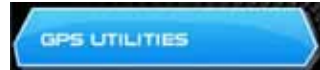

GPS Utilities – Displays Satellite Status and Time and Position Setup options.



Factory Settings – Displays boat model, center tab, surf tabs and depth transducer. A dealer code is required to access.





Diagnostics – Displays Engine, PDM, and 3 Event Diagnostics including a list of fault codes and descriptions; on some screens, corrective action will be shown.



3-Event Charts – Displays reference tables of the Slalom Timing Tolerances and Jump Timing Tolerances.

IMPORTANT: Use the 3-Event Charts for reference only. The charts will not reflect any changes, should a change occur in the rule book. We suggest periodically verifying the charts with the current rule book.

User Settings

On the Settings Menu, touch the User Settings  touch command to access the first of two user settings   screens. Touch the field following the option to change the setting. When arrows are available, touch the option to highlight it and touch the arrows to change the setting.

Touch **[Next]** to access the second screen and **[Back]** to return.



Description of Options

| Touch Commands | Description |
|-------------------|-------------------------------------|
| Units | US Standard (US Std) or Metric |
| Fire Extinguisher | Enable (Pop-up) or Disable (Pop-up) |

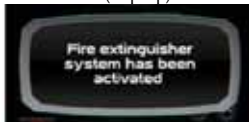

| | |
|--------------------------|---|
| Auto Volume | Enable or Disable |
| Fuel Alarm | Sets the percent of fuel left in tank to deploy the alarm |
| Min Depth Alarm | ON or OFF |
| Day Brightness | Sets the screen brightness for daylight |
| Night Brightness | Sets the screen brightness for nighttime |
| Gauge Brightness - Day | Sets the gauge brightness for daylight |
| Gauge Brightness - Night | Sets the gauge brightness for nighttime |
| Tab Settings Page | Controls the tab positions for two trim tabs on the boat. See Tab Settings. |
| Ballast Settings Page | Controls the ballast fill and drain times. See Ballast Setting. |
| Connects to GPS | YES = There is no Paddle Wheel Offset field. NO = A Paddle Wheel Offset field is provided. |
| Paddle Wheel Offset | Sets the paddle wheel offset. (Only available if GPS is not connected.) |

Tab Settings (Speed, Auto, Position)

On the User Settings Screen, touch the Tab Settings touch command to access **Tab Settings**

the Tab Settings screen. The Auto Tab Settings provide the user with the opportunity to control the tab positions for two trim tabs on the boat. The following can be controlled through these settings:

- Two Speed settings
- Trim Tab positions
- Turn Auto Limits ON and OFF
- Set the Auto Launch timing



Ballast Settings

(Tank Fill/Drain Times)

In the User Settings Screen, touch the Ballast Settings key to access the Ballast Settings screen. This screen provides the ability to control the ballast fill and drain times.

Touch the Next Setting key to move the triangle under a setting and touch the arrows to change the setting.



Service Information

On the Settings Menu, touch the Service Information touch command to access the Service Information.



This set of screens display software information and allows the dealer to reset the engine oil change intervals and the dealer service schedule.

NOTE: the Dealer Service Reset requires a dealer code to be entered before the gaining access to the screens.



Touch Commands Description



Software Version - Displays part num-

bers and versions for the application, software, operating system and more.



Dealer Service Reset - The dealer sets the number of engine running hours between servicing intervals at which time an alert will be displayed to the to the boat operator.



Oil Change Reset - Touch to reset for the next oil change alert. (The service intervals are predetermined and set by the dealer)





Dealer Information - Provides your dealers contact information such as a phone number.

GPS Utilities

On the Settings Menu, touch the GPS Utilities touch command to access the GPS Utilities screen. The GPS Utilities include the Satellite Status and the Time and Position Setup.

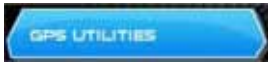

Touch Commands



GPS Status - Displays the location of the satellites.



Position Format Selection - Feature allows you to define the amount of detail to display for longitude and latitude information on the GPS map.

Time Setup Parameters - This is used to select correct time zone and clock mode for either 12-hour or 24-hour time formats. You can also enable DST (Daylight Savings

Time) by using the PLUS/MINUS soft keys to select the box.



Factory Settings

On the Settings Menu, touch the Factory Settings touch command to access the Factory Settings screen. A Dealer code is required to access this screen.

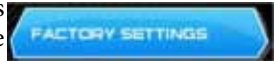



Diagnostics

On the Settings Menu, touch the Diagnostics touch command to access the Diagnostics screen.



When choosing this selection, the display will query the engine(s) ECU, as illustrated below, and provide feedback.

Touch Commands Description



Engine Diagnostics - Displays feedback on any diagnostic codes that have been activated and stored in the ECU for service needs.



3 Event Diagnostics - Displays any 3 Event fault codes that have been activated and allows you to clear faults.



PDM Diagnostics - Displays short circuits, open circuit, over current, in/out of range, and faults within the system outputs, switch inputs, analog inputs, and CAN communication.

Engine Diagnostics

On the Diagnostics Menu, touch the Engine Diagnostics touch command to access the Engine Diagnostics screen.



The following is a list of field definitions contained on the ENGINE DIAGNOSTICS screen:

Active Faults/Stored Faults

Shows the number of active faults and which fault number is currently being displayed. To advance to the next fault, touch [NEXT] and [PREV] to go back to the previous fault. Touching [BACK] returns to the Settings Menu.

- **SPN** – “Suspect Parameter Number” - fault code If not translated into text by the display, see the engine manufacturer’s literature for the definition of the SPN number.

- **FMI** – “Failure Mode Indicator” - fault code The FMI is defined by SAE J1939. If not translated into text, see the SAE standard, or the engine manufacturer’s literature.

- **Description Field** – Most common SPN’s and FMI’s have text for the description stored in the display. If there is no text, then this SPN and FMI must be defined by referring to the engine manufacturer, or the SAE J1939 standard.

NOTE: This field is only used with certain brands and models of engines.

Corrective Action (Suggested action for correction):

Get Faults

Touching [Get Faults] queries the engine(s) ECU for feedback on diagnostic codes that have been activated and stored in the ECU for service needs.

3 Event Diagnostics

On the Diagnostics Menu, touch the 3 Event Diagnostics touch command to access the 3 Event Diagnostics screen.



PDM Diagnostics

On the Diagnostics Menu, touch the PDM Diagnostics touch command to access the PDM Diagnostics screen.



3-Event Charts

On the Settings Menu screen, touch the 3 Event Touch Command to access the 3-Event Charts screen. The charts display reference tables of the Slalom Timing Tolerances and Jump Timing Tolerances.

IMPORTANT: Use the 3-Event Charts for reference only. The charts will not reflect any changes, should a change occur in the rule book. We suggest periodically verifying the charts with the current rule book.

Touch [More] to view the next page.



Touch [**Back**] to go back one page.

Touch any Quick Access Key to exit.



Troubleshooting

Problem:

Display appears not to work or doesn't come "ON".

Possible Solution:

1. Display could be in sleep mode. Touch a key on the keypad to activate the display.
2. Check for loose connections at battery and display unit.
3. Check for reversed polarity on the power connections.
4. Verify battery has a minimum voltage of 6 Volts.

Problem:

Display resets or goes "OFF" when starting engine.

Possible Solution:

1. Check display supply wires are connected properly to battery.
2. Verify battery is charged properly.
3. Check battery for efficient starter current.

Problem:

Display has no backlight.

Possible Solution:

Contact your MasterCraft service center.

Problem:

Display has no keypad backlight.

Possible Solution:

Contact your MasterCraft service center.

ProStar Additional Features



Most of the information about the ProStar's operations, standard and optional equipment is contained in the 2014 MasterCraft Owner's Manual. It is extremely important for boat owners and anyone who will be operating the boat to carefully and thoroughly review the manual prior to the first time operation.

The ProStar also has features that are unique to the boat. That information follows:

Bow Lid/Seating

The ProStar boat may come with an optional bow lid. This lid provides aesthetic appeal to the boat and pays homage to the great tournament towing boats of yesteryear. Boats equipped with the bow lid have storage space beneath it, accessible from the walkway between the helm and observer dashes. No more than 300 total pounds of gear should ever be placed in this storage compartment. Failure to maintain proper weight balance in the boat can lead to a loss of control that can result in serious injury or death.



All boats have weight limits. Failure to adhere to the posted limits can cause operation instability and/or the boat to sink. This may result in serious injury or death, as well as significant damage to the boat, which will not be covered by warranty.

The lid is not intended to be used as additional seating. Allowing individuals to move about or sit on the lid could result in damage to the lid that is not covered under warranty.

In the center of the bow is an anti-skid walkway to the bow tip. This is provided to allow swimmers access to the body of water. Individuals should use this walkway only when the boat is stopped and the engine is OFF. Walking on the walkway or exiting the boat from the bow nose at any time when the boat is running could result in an individual falling from the boat, or being run over by the boat. This could result in serious injury or death!



Never allow individuals to walk on the bow walkway or anyone to exit the boat from the bow tip unless the boat is stopped and the engine is OFF. Failure to adhere to this instruction could result in serious injury or death!

Bow seating is standard. For boats so equipped, read carefully the *Seating* information in the *Boat Operations* section of the **2014 MasterCraft Owners Manual**. Important safety information is included in that section. Care must always be taken to avoid blocking the view of the boat operator when the boat is underway. All individuals in the boat must be seated and weight properly distributed to avoid complications that can result in serious injury or death.



When boats are in motion, operators and passengers should always be seated on upholstered designated occupant seating. No other areas should be used during op-

eration, including, but not limited to, the gunwales, towers, sun pads, engine boxes, or any area that is not clearly intended for seating while the boat is underway. People can become dislodged from locations that are not actual seating, which could result in falls in the boat or overboard, resulting in serious injury or death.



Ski Racks

The boat may be equipped with ski racks in the gunwales on both sides. These ski racks are constructed with anodized aluminum and particular attention must be paid to prevent corrosion. See *Corrosion* in the *Care and Maintenance* section of the **2014 MasterCraft Owner's Manual** for additional details.

The ski racks operate easily by tapping the lower bar of the assembly. Holding down on the bar keeps the ski rack holder open for easy access or storage of the skis. Releasing the lower bar closes the rack and holds the skis in place. Prior to operating the boat,

always check that the skis are secure in the rack. Failure to do so could result in a ski or skis becoming dislodged during boat operation. This could result in the skis striking individuals seated in the aft portion of the boat or the skis going overboard.



Always verify that skis stowed in the gunwale ski racks are secure prior to operation of the boat. Otherwise, skis may become dislodged and strike passengers in the aft section of the boat or the skis going overboard.

ProStar Tower

Due to time constraints for printing, the tower information is provided in a separate document. Please read that material for important step-by-step directions for correctly operating the tower.

Navigational Lighting

ProStars not equipped with tower lighting have navigational lighting valid for INLAND RULES only.

Index

| | |
|----------------------------|------|
| Bow Lid/Seating..... | 9-27 |
| Guide to Components..... | 9-2 |
| Introduction..... | 9-1 |
| Navigational Lighting..... | 9-28 |
| ProStar Tower..... | 9-28 |
| Ski Racks..... | 9-28 |
| Statistics..... | 9-2 |

The following are all related to Video Screen:

| | |
|--|------|
| 3-Event Charts..... | 9-25 |
| 3-Event Diagnostics..... | 9-25 |
| Access Keys, Quick..... | 9-4 |
| Audio..... | 9-5 |
| Ballast and Trim..... | 9-5 |
| Ballast Settings, (Tank Fill/Drain Times)..... | 9-22 |
| Basic Navigational Features..... | 9-4 |
| Care and Maintenance..... | 9-4 |
| Charts, 3-Event..... | 9-25 |
| Commands, Touch Point..... | 9-4 |
| Course Manager-All Slalom and Jumping Events..... | 9-14 |
| Current Profile, Delete..... | 9-11 |
| Delete Current Profile..... | 9-11 |
| Diagnostics..... | 9-24 |

| | |
|--|------|
| Diagnostics, 3-Event..... | 9-25 |
| Diagnostics, Engine..... | 9-24 |
| Diagnostics, PDM..... | 9-25 |
| Engine Diagnostics..... | 9-24 |
| Events, Tournament..... | 9-12 |
| Factory Settings..... | 9-23 |
| Gauges..... | 9-5 |
| GPS Utilities..... | 9-23 |
| Heater and Lights..... | 9-7 |
| Jump Screen-Tournament or Training..... | 9-16 |
| Jump Settings-Tournament or Training..... | 9-17 |
| Jumping Events, Course Manager- All Slalom and..... | 9-14 |
| Keys, Quick Access..... | 9-4 |
| Lights, Heater and..... | 9-7 |
| Maintenance, Care and..... | 9-4 |
| Menu, Settings..... | 9-20 |
| Navigational Features, Basic..... | 9-4 |
| PDM Diagnostics..... | 9-25 |
| Profile, Delete Current..... | 9-11 |
| Profiles..... | 9-8 |

| | |
|---|------|
| Quick Access Keys..... | 9-4 |
| Settings (Speed, Auto, Position), Tab..... | 9-21 |
| Settings Menu..... | 9-20 |
| Settings, (Tank Fill/Drain Times), Ballast..... | 9-22 |
| Settings, Factory..... | 9-23 |
| Settings, Tournament or Training, Jump..... | 9-17 |
| Settings, Tournament or Training, Trick..... | 9-19 |
| Settings, User..... | 9-20 |
| Slalom and Jumping Events, Course Manager-All..... | 9-14 |
| Slalom Screen-Tournament or Training..... | 9-12 |
| Tab Settings (Speed, Auto, Position)..... | 9-21 |
| Touch Point Commands..... | 9-4 |
| Tournament Events..... | 9-12 |
| Tournament or Training, Jump Screen..... | 9-16 |
| Tournament or Training, Jump Settings..... | 9-17 |
| Tournament or Training, Slalom Screen..... | 9-12 |
| Tournament or Training, Trick Settings..... | 9-19 |
| Trick Settings-Tournament or Training..... | 9-19 |
| Trim, Ballast and..... | 9-5 |
| Troubleshooting..... | 9-26 |
| User Settings..... | 9-20 |
| Utilities, GPS..... | 9-23 |
| Video..... | 9-7 |