



Mastek

2003 OWNERS MANUAL

Welcome Aboard



Congratulations on your choice of the finest ski boat available. MasterCraft is the recognized world leader for inboard ski boats today and has been for 35 consecutive years. The quality, innovation, selection and value are unmatched in the industry.

Please take a few minutes to read this owners manual completely in addition to carefully reviewing the Operations and Maintenance Manual that was also provided with your new boat. These publications will help answer most of the remaining questions you may have about your new boat.

Every effort has been made to make this manual accurate. All information is based on the latest product information available at the time of printing.

Because of our policy of continuous product improvement, we reserve the right to make changes at any time, without notice, in specifications and models and also to discontinue models. The right is also reserved to change specifications, parts or accessories at any time without incurring any obligation to equip the same on models manufactured before the date of the change.

The continuing accuracy of this manual cannot be guaranteed. The illustrations used in this manual are intended only as representative reference views and may not depict actual model component parts. Information about certain on-board components furnished by suppliers other than MasterCraft is provided separately. This information is available from your dealer.

Purchasing a new MasterCraft, MariStar or X-Series boat has the added benefit of automatic one-year membership in the fun that is Team MasterCraft. And your membership will be renewable in succeeding years, too.

No other manufacturer offers so much in terms of product, customer service, an outstanding dealer network and just pure fun by keeping other boat owners like you informed in print and online, and bringing you together in social settings.

As a member of the exclusive Team MasterCraft, you will receive:

- A Team MasterCraft tee-shirt.
- A membership kit filled with custom Team MasterCraft items.
- A personalized membership card and certificate.
- A year's subscription to STAR, the official MasterCraft owners' magazine.

You'll also be invited to special events around the country throughout the year.



Welcome to the Wonderful World of Team MasterCraft

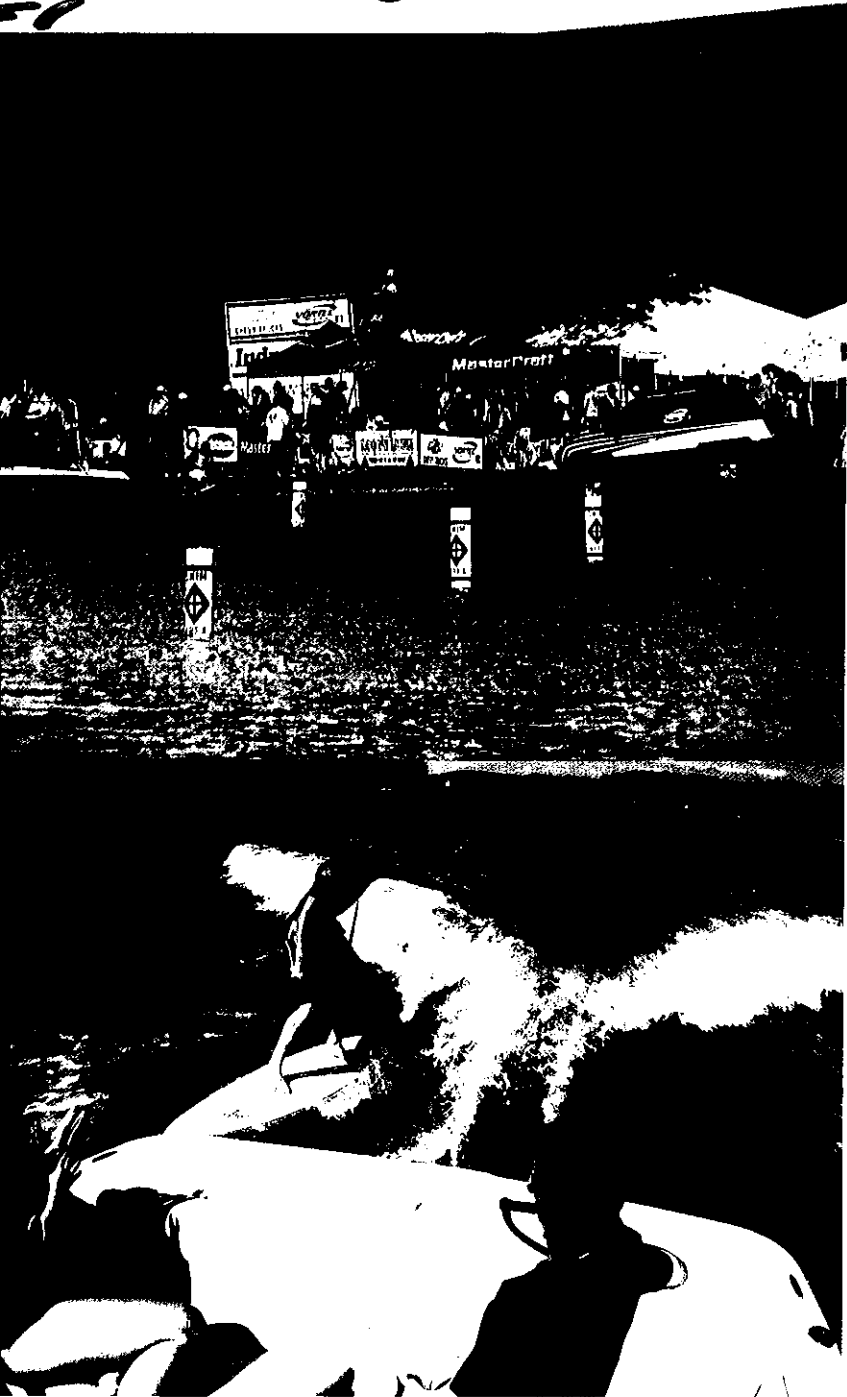

Among the national, regional and local events about which you'll learn more and be invited to attend are the Water Ski Pro Tour, Regional Amateur Championships, and MasterCraft Reunion events. At most of these, you'll also be allowed into restricted areas set aside for Team MasterCraft, with excellent views of on-water events, and lots of opportunities to compare notes with other Team members, admire each others' boats, compete for prizes and have a wonderful time.

As sponsor of many events and a Pro Team of skiers and wakeboarders, MasterCraft is hands-on in the sport. You'll have opportunities to meet, receive autographs from and talk to some of the top stars. You'll also take pride when you see MasterCraft boats pulling events on television—and even in the movies!

MasterCraft will also alert you to very special events, such as Camp MasterCraft, where "kids" of all ages attend to learn more about skiing and wakeboarding. You can keep track of everything by logging on to www.mastercraft.com, and checking out all the exciting events going on around the country for Team MasterCraft members!

The MasterCraft Design Process: The Perfect Blending of Art and Science

Our engineers and designers have never been able to leave well enough alone. Armed with true 3-D computer-aided design technology, they have a design approach that allows them to visualize and create every part of the boat on the computer—the same way done in the automotive industry. No other ski boat company even comes close to our technology—or to our talent. It's the most advanced team in the business, and the fruits of its labor are evident in every 2003 MasterCraft model.

But at MasterCraft, we're not just designing better boats. We're designing better ways to build them. Today's MasterCrafts are built better, smarter and lighter. Which means you have the most durable, most carefree and most reliable boat on the planet.

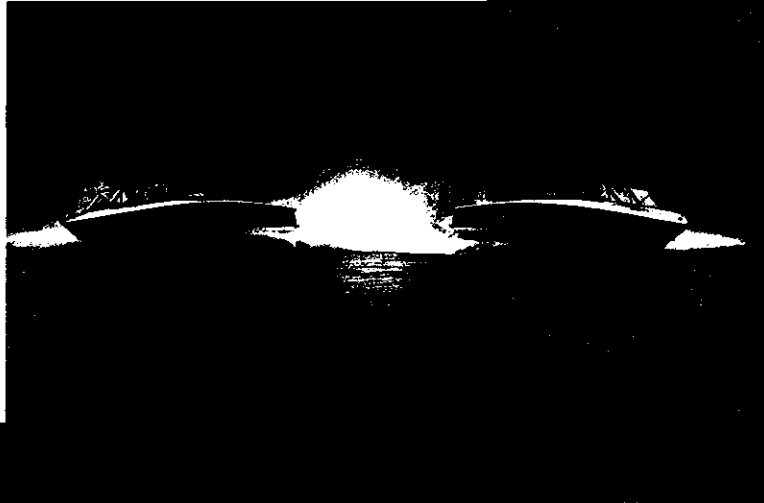
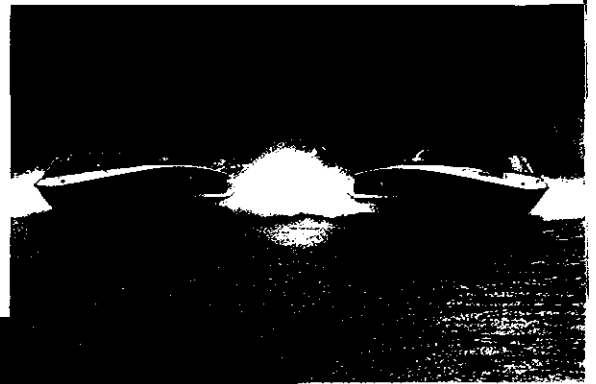

The photographs on this page feature the MasterCraft ProTournament 190 and ProTournament 197, demonstrating some of the power, grace and beauty of these special edition boats under the guidance of professional drivers.

HOW YOUR BOAT

Even with the most advanced technology available, however, MasterCraft will never replace an important step in the design: *Hands-on involvement*. Our artisans use clay modeling, inspired by the automotive industry, to touch and feel every surface of the boat before it ever sees a mold. Changes are made overnight. And re-made over and over again until every aspect of the ergonomics, styling and design is just right. When everything is flawless, we build the part, carefully crafting each piece by hand. This careful blending of technology experience and intuition allows us to reduce the time it takes to introduce innovations into our boats.

We're proud of the balance we've achieved and of the results we're getting. For example, parametric modeling and finite element analysis allow us to create computerized images of each part long before we build it. We zero in to test stress levels and to perfect tolerances to the least thousandth of an inch. The result is a boat that has minimum weight and maximum strength. A boat that is powerful, durable and seamless from bow to stern.

The MasterCraft LifeMaster™ Construction Process

We use an exclusive process that we call LifeMaster™, an eight-step production method that gives every MasterCraft strength and reliability that ordinary boats cannot equal. We believe in this process so much that we offer a limited lifetime warranty on every new MasterCraft. The warranty is even transferable to a second owner for up to five years.

Step 1: Superior Molds

The first step in the LifeMaster™ Process is our boat molds. Our molds are built to tighter tolerances than most boats, with steel reinforcement to prevent flexing and to maintain precision. After every fourth use, molds are hand-waxed with an industrial quality paste wax. This ensures a mirror-like gel coat finish and easy mold release. After 50 uses, every mold is sent back to the mold maintenance shop for a complete overhaul, allowing us to produce a boat with a superior finish. Also note that our molds are green in color. Our molds used to be orange, but we discovered that the green pigment was more environmentally friendly (*no lead*), so we switched.

Step 2: Gel Coat

Boats are built from the outside in. The first layer to be applied to the model is our special Ultimate 8000™ neopentyl glycol/isophthalic 20 mil gel coat. Our skilled production team can control our gel coat to tolerances within .005" for optimum strength, gloss and resistance to cracking, fading, blistering and water and chemical damage. Most manufacturers do not even have standards for gel coat thickness.

Some graphics are applied right in the gel coat, and this extra care pays off. New MasterCrafts come out of the mold with a gloss that looks like they were just waxed and buffed.

Step 3: Hand-Laid Fiberglass

There are many ways of building boats, but the best way we have found is to do it by hand. MasterCraft uses multiple layers of hand-laid fiberglass for the hull and structural components. Three types of fiberglass are used: matting, women roving and coremat. There are even two types of woven roving—biaxial stitched and triaxial stitched cloth.

Why so many? Because the different types of fiberglass provide strength in different directions. The result is a hull that resists the

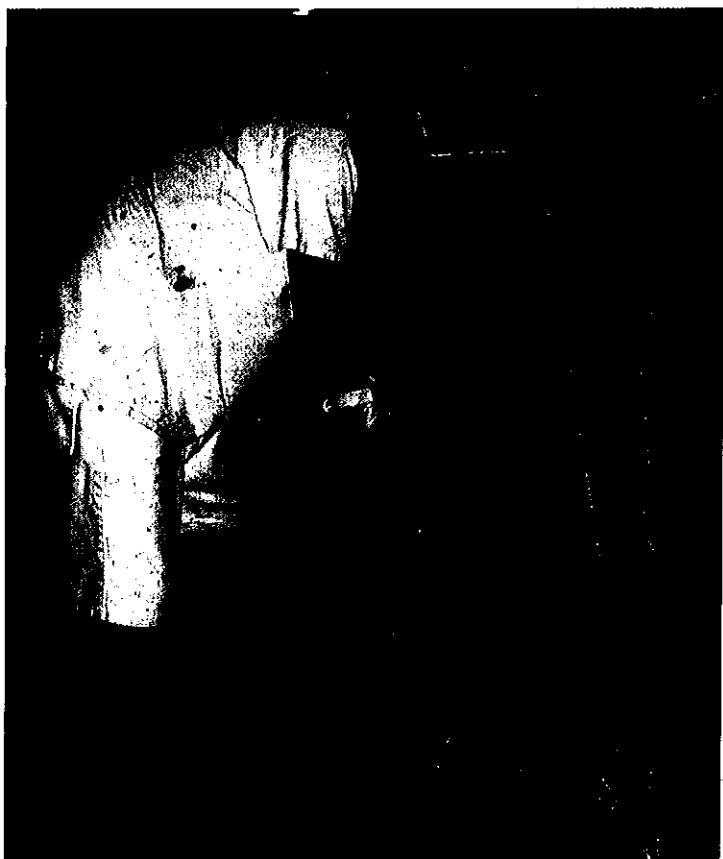

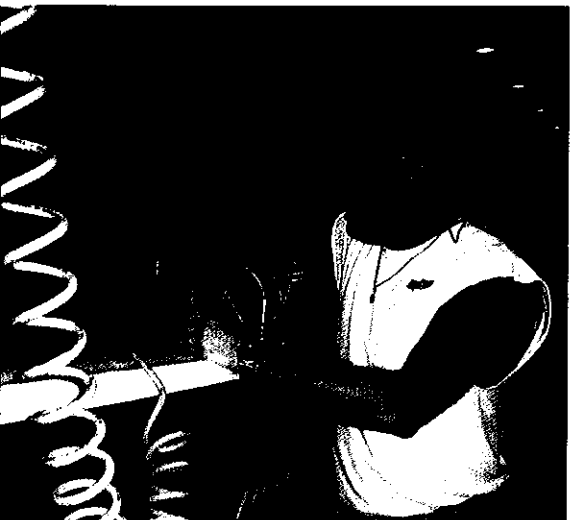

tremendous forces generated by running across the water at high speed and taking tight turns.

Our hand-laid method is superior to chopper-gun fiberglass application because it ensures uniform strength and consistency throughout the boat. Chopper guns can create thin spots in the hull that are weak.

Step 4: Integral Monocoque™ Stringer System

MasterCraft uses no wood for structural components. Over time, wood weakens and rots. MasterCraft pioneered the use of fiberglass stringers (or *hull bracing system*) in ski boat construction.

All the way back in 1983, we developed an entirely new stringer system. The exclusive Monocoque™ stringers, constructed of bi-directional fiberglass and closed-cell foam, are precision built to aerospace tolerances, then fiberglassed into the hull so that they become an integral part of the structure. It is as if the hull and stringers are one single piece.

That means extra strength, more stability, and a great feel for the driver.

Step 5: Floor Liner

The fiberglass floor liner, another hull component that adds strength, is chemically bonded with GlassLock to the hull and stringers, under tons of pressure. The result is a bond that is stronger than the fiberglass itself, proven far superior to mechanical bonds that other companies use.

Then, 3/8" AnchorLOK reinforcement steel plates are laminated into the hull to provide rigid mounting points for the engine, ski pylon, rear lifting rings and the swim platform. Many boat companies mount the engine and other components directly into fiberglass or wood, resulting in stress cracking and inevitable failure.

Step 6: Foam Flotation

After the floor liner is in place, pressurized closed-cell flotation is injected into the spaces between the hull and floor liner to produce a solid, rigid, one-piece structure. Foam also deadens noise and provides positive flotation for the boat, which is an added safety feature.

Coast Guard regulations do not require foam in boats over 20-feet in length, but all MasterCraft models feature foam.

Step 7: Composite Floor Panels/Drive Train Covers

The next step in the process is to install floors made of composite materials in the hull of the boat to cover the drive train. These units are both strong and lightweight. Unlike wood, they will never warp or rot. This is critical because carpet can absorb water and hold it, causing wood floor panels to start deteriorating long before the rest of the boat.

Step 8: Bonding Deck and Hull

The final step in the LifeMaster™ process is to bond the deck and hull together. The deck is mechanically bonded to the hull with silicone and fasteners for strength, water tightness and durability.

Some companies simply use fasteners to bond the deck and hull together. This can create stress points in the fiberglass. Others use fiberglass to seal the joint, but this can cause problems if there is ever a need to remove the deck for a major repair.

Our system uses stainless steel fasteners that are anchored into a high density polyethylene DuraBak backing strip. This takes the pressure off the fiberglass and

provides a bond that is exceptionally strong—but can be taken apart if there ever the need for a major repair.

Small Fiberglass Parts

Like the hull of the boat, all small fiberglass components, such as trailer henders and motor boxes are constructed of hand-laid fiberglass for strength. A separate manufacturing line dedicated to these components.



Putting the Pieces Together

Rigging

On the rigging line, all interior components such as engines, fuel tanks, carpet, upholstery and finish details are hand-installed by skilled craftspeople. Every MasterCraft comes pre-wired for all available options and has a moisture-proof wiring harness.

The order of installation has been carefully choreographed so that parts are never in the way of workers and therefore do not get damaged.

MasterCraft Marine Power Engines By Indmar

The standard engine for 2003 is the Predator, a Vortec 5.7-liter V-8 engine with electronic throttle-body fuel injection. One ride makes it clear how it got its name. For those who want even more power, however, there is also the optional 5.7-liter MCXT™. This 350-horsepower ski-specific, multi-port EFI V-8 is Vortec-based and features an exclusive MasterCraft/Indmar fuel delivery system with an elongated, ski-tuned plenum. It produces jump-up acceleration and an astonishingly broad, flat torque curve all the way to wide-open-throttle. And the big daddy, the new Vortec L18 HO 8.1-liter V-8 with 496 cubic inches puts out a whopping 450 horsepower.

Our exclusive EFI Management System™ controls all our engines in three key areas: fuel, spark and air. This system constantly monitors more than 30 engine factors to calculate the optimum performance under any load, in any condition and at any altitude. We program each electronic control module (ECM) to pinpoint the optimal RPMs, fuel quality and coolant temperature needed to give each engine model maximum skiability. If there's a problem the ECM reacts within microseconds to correct it or to prevent any further damage to the engine.

That is what makes our engines smarter. But they are tougher, too, because of extra quality steps like a waterproof ECM, a seven-step paint process, precision machining of components and crankshaft-driven water pumps. And don't forget, MasterCraft engines come with a three-year warranty.

But we couldn't talk about engines this year and forget the award-winning Cadillac® Northstar®, which cranks out tons of torque at every speed from idle to full-throttle. However, its torque release is biased toward mid-range situations. This engine has power exactly where the skier wants it.

Limp-home mode shuts down individual cylinders if the engine ever loses coolant. Each Northstar® engine comes standard with a closed cooling system and is mated to MasterCraft's famous 1.5:1 PowerSlot transmission.

It's fitting that MasterCraft would team up with Cadillac®. And that, of all the boat manufacturers in the world, Cadillac® would choose to align itself with MasterCraft and Indmar.

Upholstery

MasterCraft produces its own custom upholstery using multiple layers of high density CelMaster™ foam, rotocast polyethylene frames and backs (*instead of wood*), premium vinyl and triple stitching.

MasterCraft uses the highest grade marine vinyl with more than double the surface weight and 20% more tear-resistance than vinyl used on other boats. It is treated with mildew inhibitors and UV-protected triple stitching combined with reinforced backing and heavy-duty UV-protected thread keeps the upholstery together. It has been rigidly tested under all sorts of circumstances to make sure it keeps its color and does not crack, even after years of use. In some places, the vinyl is foam-backed so that it gives a more defined curve around edges and provides a more tailored look.

Our upholsterers are experienced craftspeople. Some have more than 20 years of upholstery experience. And every metal component on a MasterCraft is either stainless steel or other non-corrosive material. Even upholstery staples are marine grade stainless steel. Upholstery has a one-year warranty.

Lake Testing

Every MasterCraft that comes off our assembly line must pass a 30-point quality assurance on-the-water test. A TECH1 analyzer is used to check for engine anomalies and to calibrate all gauges. Steps are taken to resolve any issues before the boat can be prepped for shipment.

Final Finish

Although our Ultimate 8000™ gel coat has remarkable luster on its own, every new MasterCraft is carefully cleaned and mirror-glazed before it is loaded.

Many of our new owners show up to see their new boat unloaded off the truck, and we want to make sure that it is love at first sight! Our boats are also shrink-wrapped to keep them clean and carefully loaded onto our own trailers for delivery.

Custom Trailers

MasterCraft trailers are custom-made to precisely fit our ski boats. They are made of tubular steel for strength, with steel reinforced fiberglass fenders.

Trailers are carefully prepped after they are welded together because we think the finish on the trailers is as important as the finish on the boat. All trailers have a two-part polyurethane paint system for a lasting finish. The paint is matched to the base color of the boat.

Here are some other important trailer features:

Radial tires with custom MasterCraft aluminum rims.

Tandem axle trailers get disc brakes on both axles.

EZ Load system makes it easier to get the boat out of the water.

Guide bars.

Standard disc brakes on all trailers.

Standard Bearing Buddy for longer life, less maintenance.

Coiled covered safety cables instead of chains.

Waterproof lights.



Descriptions and Information



2003 Individual Models

197

Length of Boat: 17'3"

Length of Boat with Platform: 21'6"

Width Amidship: 91"

Overall Length w/ Trailer: 22'10"

Weighting w/ w/ tongue folded: 21'11"

Overall Width w/ Trailer:

99" (single axle)

100" (tandem axle)

Boat Weight: 2,800 lbs. (approx.)

Single Axle Trailer Weight: 360 lbs.

Tandem axle trailer Weight: 1,040 lbs.

Fuel Capacity: 28 gallons

Depth of Transom: 20"

Depth Amidships: 23 1/2"

Draft: 22"

Max Boat Height to Waterline: 29"

Capacity: 10 people or 1,340 lbs.

SeaStar

LAYOUT

- A FUEL TANK FILLER
- B BLOWER EXHAUST
- C SWIM PLATFORM
- D STERN LIGHT RECEPTACLE
- E STORAGE UNDER SUN PAD
- F ENGINE COMPARTMENT
- G THROTTLE/SHIFT CONTROL
- H INSTRUMENT PANEL
- I BOW LIGHT
- J GLOVE BOX
- K BATTERY (UNDER SEAT)
- L FIRE EXTINGUISHER (BEHIND SEAT)
- M DRAIN PLUG

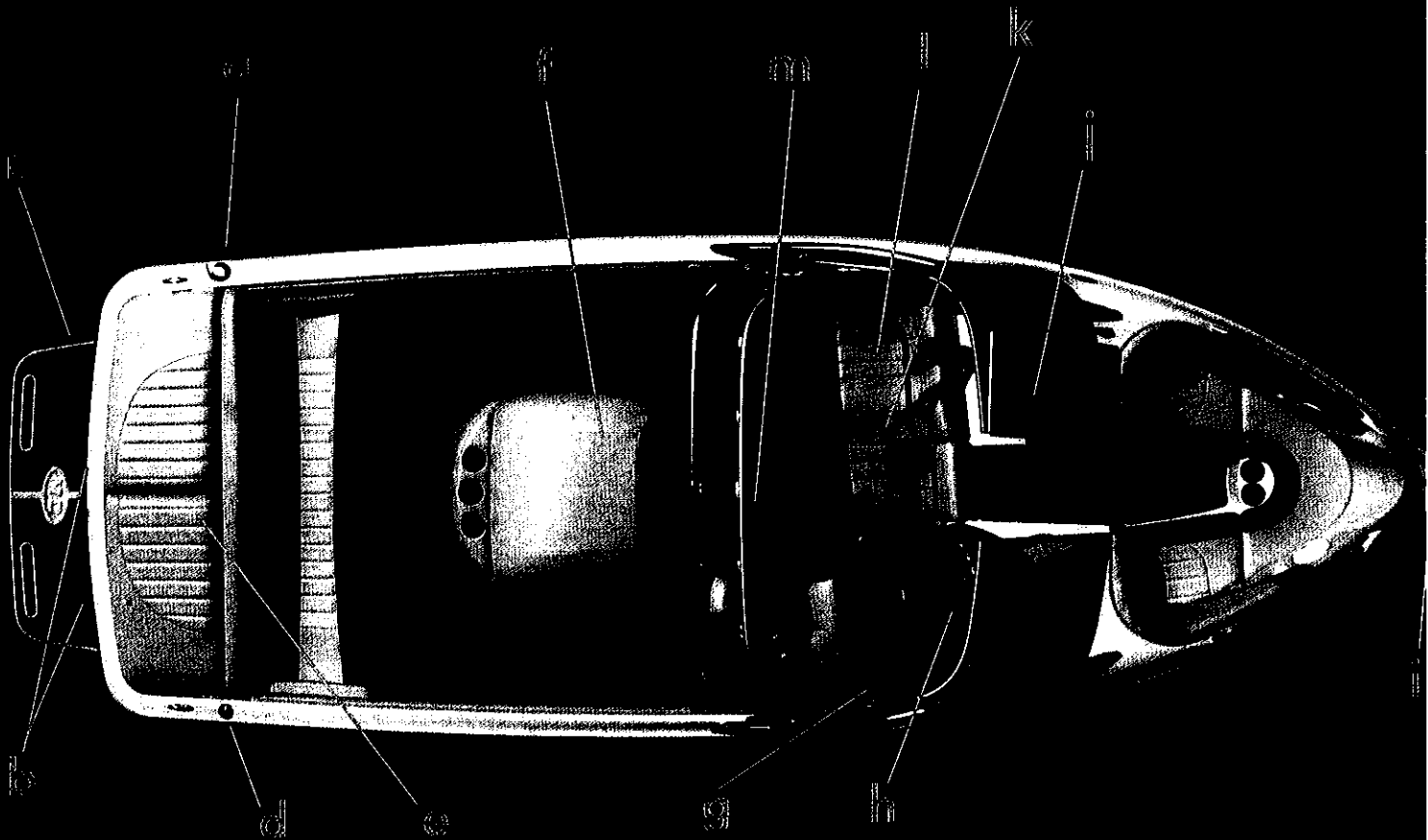

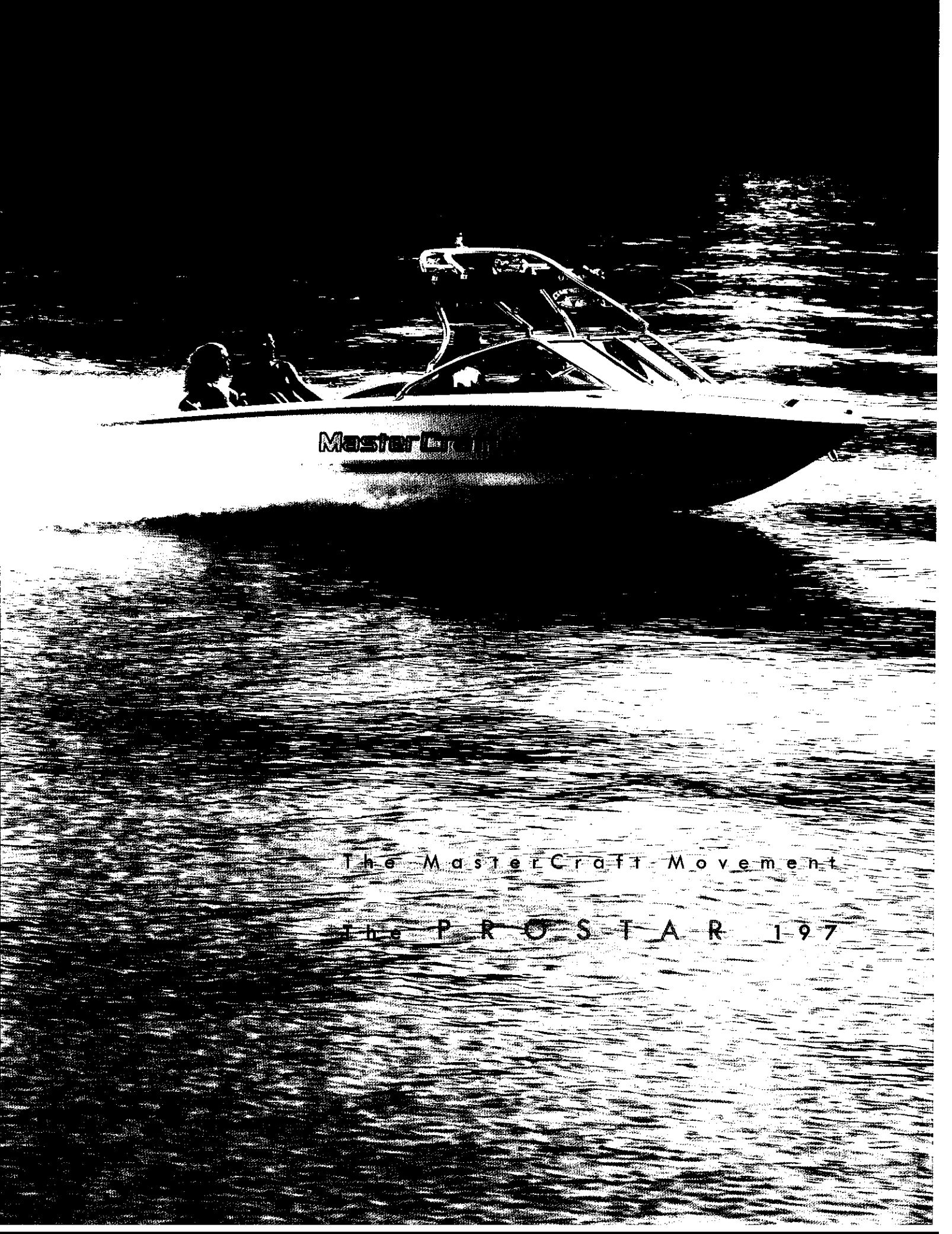

MasterCraft

The MasterCraft Movement

The PROSTAR 197

Standard Equipment

Propulsion and Systems

MasterCraft Power Vortec Predator 5.7L EFI
TBI 350-cubic-inch GM V-8 engine—310 hp
1:1 gear ratio transmission
4-blade 13-inch propeller
3-year limited engine warranty
Competition throttle control
Dual exhaust system
Dual fuel filtration system
Engine temperature gauge
EZ Change oil kit
Fuel gauge
High-pressure in-tank fuel pump
Low-battery voltage alarm
Oil pressure gauge
Silent Master muffler/exhaust system
Tachometer with hourmeter
Voltmeter

Comfort and Convenience

Two (2) 12-volt DC power outlets
Built-in cooler with drain and dual access
Center drain with threaded drain plug
Chronograph clock
Companionway walk-thru wind enclosure,
canvas
Custom polished aluminum steering wheel,
ergonomically designed
Eight (8) drink holders
MasterView driver's seat
Gas-filled lifts for motor box cover
Glove box, water-resistant with space for
stereo and integral shelf
Observer's seat—aft facing (fits 3
people)
Illuminated lockable storage behind
observer's seat
Recessed floor area with drain—driver's area
Storage under bow seating
Storage under sun pad, illuminated
Sun pad—hinged, full access, split deck
Teak swim platform, removable
Tilt steering wheel
Two-piece fully insulated motor box

Construction

All hand-laid fiberglass construction
All stainless steel and non-corrosive hardware
Aluminum floorboards
AnchorLok reinforcing plates, steel,
aluminum, or HDPE, on all key parts
Bow eye, stainless steel
CelMaster reticulated dry-foam seat
construction
Circuit breakers
Cross-linked polyethylene fuel cell
Curved tempered safety glass windshield
Drip-molded decals
Exclusive splined propeller and propeller
shaft with lock nut
Gel coat tolerances to +/- .005"
Heavy-duty 40 oz. Marine carpet with
5-year limited warranty

Integrated gel coat striping
M.O.D.S. MasterCraft Oscillation Dampening
System for noise and vibration reduction
Magnesium bronze rudder box with o-rings
and grease fittings
Magnesium bronze rudder with 1-1/8"
stainless steel shaft
Magnesium bronze strut with 8-bolt mounting
and dual bearings
MasterCraft custom steering connection with
grease fittings
MasterCraft electromechanical custom
gauges
Monocoque integrated stringer system
No-spill gas fill

Safety engine stop switch

Wakeboarding and Water Ski Performance

Adjustable, oversized convex mirror with
bracket, removable
USA Water Ski-approved
Parabolic tracking fins
Side panel ski storage
Swing-open center seat for walk-thru
Transom ski tow eye
Two (2) tournament speedometers
Wear-Guard anodized aluminum ski pylon,
patented

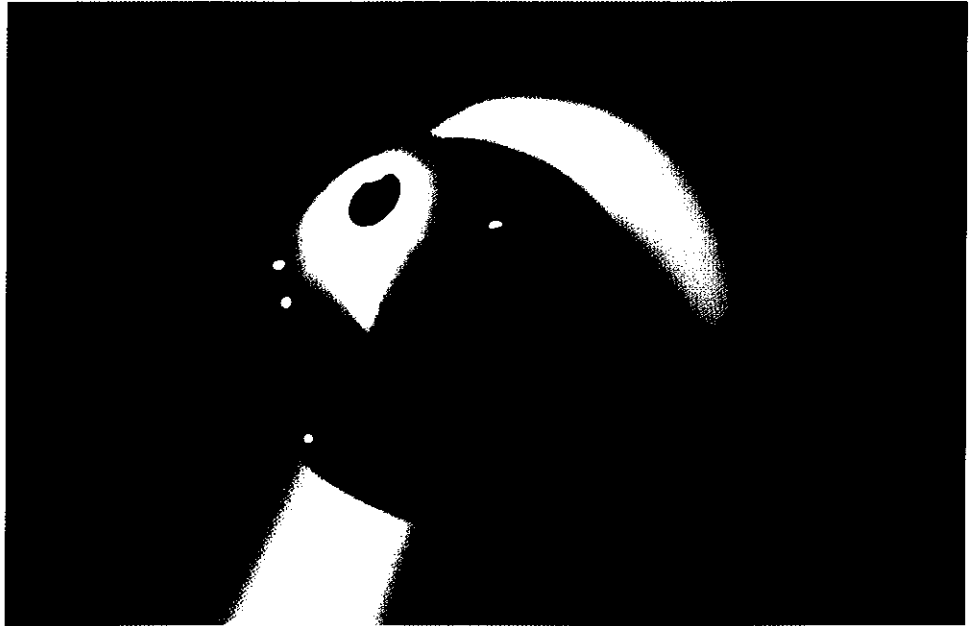

On-water quality assurance testing of
every boat
Precision Touch II rack-and-pinion steer-
ing system
Rigid PVC rub rail with vinyl insert
Stainless steel interior bow hand rails
Stainless steel upholstery staples
Steel-reinforced molds
Stern eyes
Transferable hull-and-structural components
limited lifetime warranty
Wiring harness with color-coded and
labeled wires—meets ABYC standards
Vinyl—34 oz. premium grade with UV
protection and mildew resistors, UV-
protected threads

Safety

Automatic/manual bilge pump system
Bilge blower
Engine warning light and alarm
Fire extinguisher
Flotation exceeding USCG requirements
Horn
Inland lighting
NMMA-certified for safety

Optional Equipment

Propulsion and Systems

MasterCraft Power Vortec MCX 5.7L multi-
port EFI 350-cubic-inch GM V-8 engine—
350 hp
MasterCraft Power Vortec Cadillac LQ9 HO
6.0L multi-port EFI V-8 engine—385 hp
MasterCraft Power Vortec L18 HO 8.1L EFI
496-inch GM V-8 engine—425 hp
1.5:1 gear ratio patented PowerSlot
package (includes 4-blade 14x18
propeller)
Closed cooling system (not available with
shower, standard with Cadillac LQ9 engine)
European package
Hood scoop (available with medium motor box)

Canvas and Carpet

Bimini top (dealer-installed)
Bow tonneau cover (dealer-installed)
Cockpit mooring cover (dealer-installed)
Sun top (dealer-installed)
Towable boat cover
Towable boat cover for tower

197

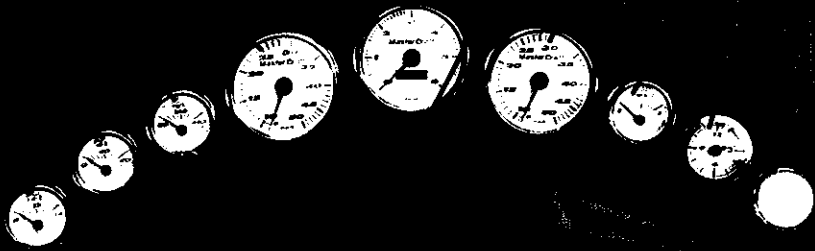

Comfort and Convenience

- Clarion AM/FM CD stereo system with four marine speakers with digital read-out remote on instrument panel
- Clarion AM/FM CD stereo system with subwoofer and high-power amp (500 watts) with digital read-out remote on instrument panel
- Clarion 6-disc CD changer
- Clarion transom-mounted stereo digital read-out remote control
- Depth finder
- Fiberglass swim platform—removable, available in all gel colors
- Heater
- Pressurized hot/cold shower (not available with closed cooling system)
- Pull-up cleats for bow (stainless, flush-mounted)
- Pull-up cleats for stern (stainless, flush-mounted)

Construction

- Extended warranty
- Custom gel coat
- Metal flake gel coat
- Rearrangement of upholstery colors

Wakeboarding and Water Ski Performance

- MasterCraft Training System (MTS)
- Rear Ballast System
- Both MTS and Rear Ballast System
- Perfect Pass Digital Pro
- Perfect Pass Cruise
- Perfect Pass Wakeboard Edition
- Binding Blaster soap pump
- Teak transom saver (not available with fiberglass swim platform)

- Tournament KPH speedometers (two—no-charge option)
- Water temperature gauge (in place of clock)
- ZeroFlex Flyer, standard or mini-tower with board or slalom racks (two sides)
- Slalom rack (one side)
- Clarion tower speakers (150 watts each) with amp
- Two sets of tower speakers
- Two sets of speakers with lights (kit includes two lights/four speakers)
- Tower light bar with four lights (either two forward and two aft, or four aft)

Trailers

- Canadian-approved trailer

- Galvanized single-axle trailer with disc brakes with swing-away tongue
- Galvanized tandem-axle trailer with disc brakes with swing-away tongue
- Single axle trailer with disc brakes with swing-away tongue
- Tandem axle trailer with disc brakes with swing-away tongue
- Spare trailer tire and wheel assembly (available aluminum or galvanized)

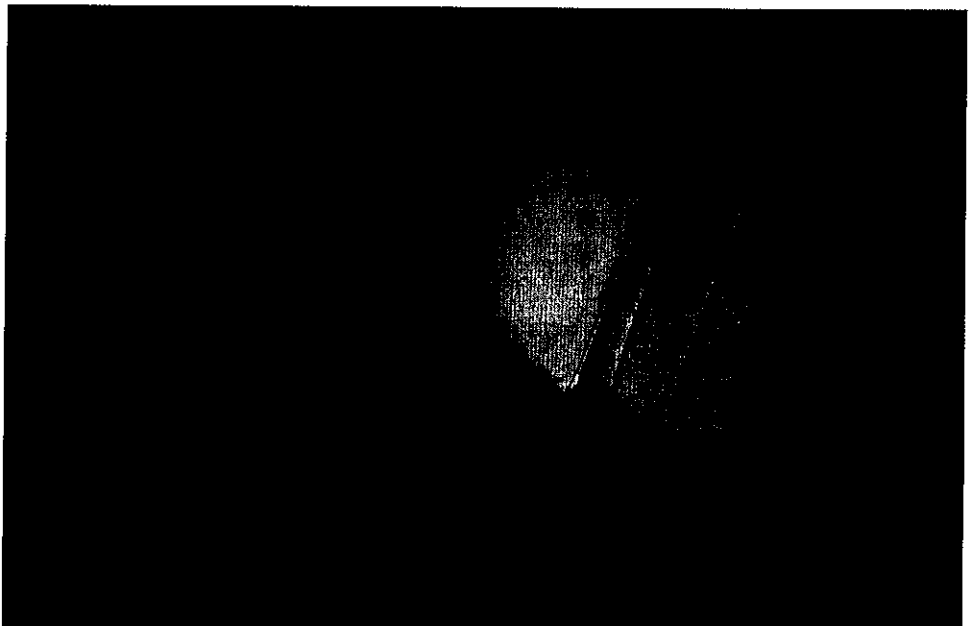

PROSTAR

197

ENJOY DUAL SIGNATURE SERIES

- Length of Boat: 17'3"
- Length of Boat with platform: 21'5"
- Width Amidships: 91"
- Ball Length w/ Trailer: 22'10"
- Ball Length w/ Tongue Balled: 21'1"
- Overall Width w/ Trailer: 92" (single axle)
- 100" (double axle)
- CG Weight: 2,300 lbs. (approx.)
- CG Weight Trailer: 850 lbs.
- CG Weight Trailer: 1,030 lbs.
- Oil Capacity: 23 gallons
- Depth of Transom: 20"
- Depth Amidships: 25.1"
- Depth: 22"
- CG Height to Maindeck: 29"
- CG Height to Platform: 40"
- Capacity: 10 people or 1,340 lbs.

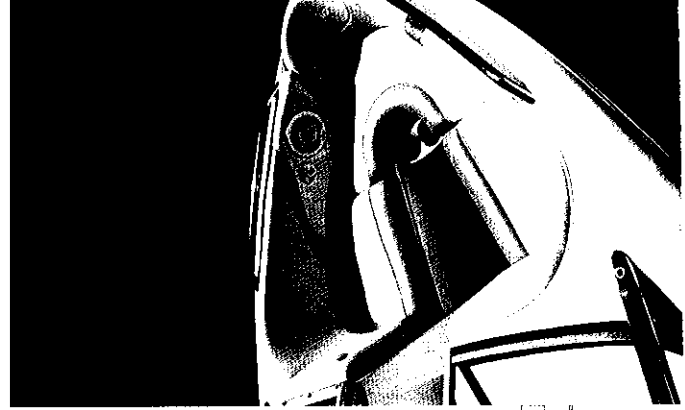

LAYOUT

- A FUEL TANK FILLER
- B BLOWER EXHAUST
- C SWIM PLATFORM
- D STERN LIGHT RECEPTACLE
- E STORAGE UNDER SUN PAD
- F ENGINE COMPARTMENT
- G THROTTLE/SHIFT CONTROL
- H INSTRUMENT PANEL
- I BOW LIGHT
- J GLOVE BOX
- K BATTERY (UNDER SEAT)
- L FIRE EXTINGUISHER (BEHIND SEAT)
- M DRAIN PLUG

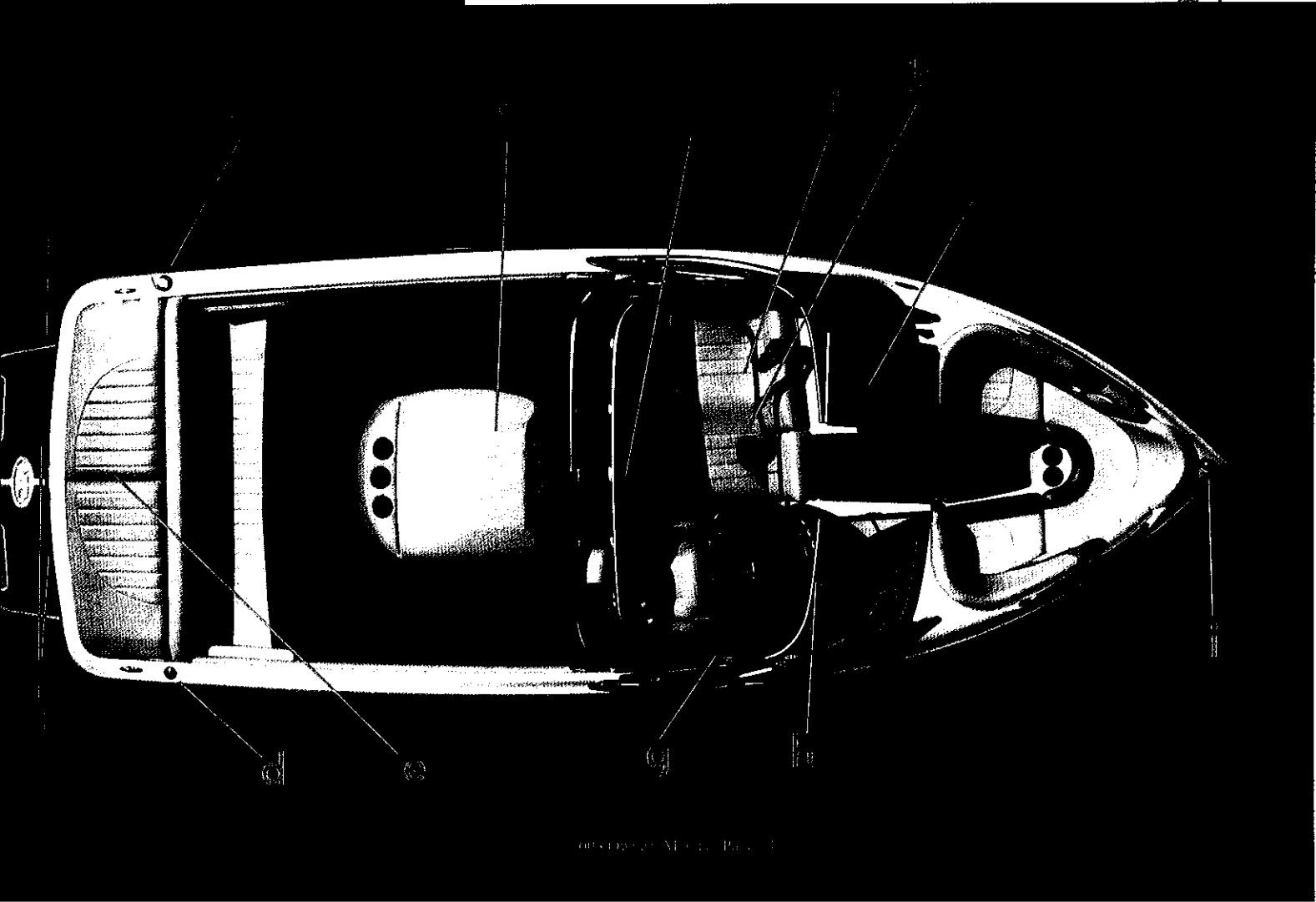



The MasterCraft Movement

The PROSTAR 197

Sammy Duvall Signature Series

Standard Equipment

Propulsion and Systems

MasterCraft Power Vortec MCX 5.7L multi-port EFI 350-cubic-inch GM V-8 engine—350 hp
1:1 gear ratio transmission
4-blade 13-inch propeller
3-year limited engine warranty
Competition throttle control
Dual exhaust system
Dual fuel filtration system
Engine temperature gauge
EZ Change oil kit
Fuel gauge
High-pressure in-tank fuel pump
Low-battery voltage alarm
Oil pressure gauge
Silent Master muffler/exhaust system
Tachometer with hourmeter
Voltmeter

Comfort and Convenience

Two (2) 12-volt DC power outlets
Built-in cooler with drain and dual access
Center drain with threaded drain plug
Chronograph clock
Custom polished aluminum steering wheel, with billet center cap
Eight (8) drink holders
MasterView driver's seat
Gas-filled lifts for motor box cover
Glove box, water-resistant with space for stereo and integral shelf with stainless steel latch
Observer's seat—aft facing (fits 3 people)
Illuminated lockable storage behind observer's seat
Recessed floor area with drain—driver's area
Storage under bow seating
Storage under sun pad, illuminated
Sun pad—hinged, full access, split deck
Teak swim platform, removable
Tilt steering wheel
Two-piece fully insulated motor box

Construction

All hand-laid fiberglass construction
All stainless steel and non-corrosive hardware
Aluminum floorboards
AnchorLok reinforcing plates, steel, aluminum, or HDPE, on all key parts
Bow eye, stainless steel
CelMaster reticulated dry-foam seat construction
Circuit breakers
Cross-linked polyethylene fuel cell
Curved tempered safety glass windshield
Drip-molded decals, including Sammy Duvall Signature Series decal
Exclusive splined propeller and propeller shaft with lock nut
Gel coat tolerances to +/- .005"
Heavy-duty 40 oz. marine carpet with 5-year limited warranty

Integrated gel coat striping
M.O.D.S. MasterCraft Oscillation Dampening System for noise and vibration reduction
Magnesium bronze rudder box with o-rings and grease fittings
Magnesium bronze rudder with 1-1/8" stainless steel shaft
Magnesium bronze strut with 8-bolt mounting and dual bearings
MasterCraft custom steering connection with grease fittings
MasterCraft electromechanical custom gauges
Mono-coque integrated stringer system
No-spill gas fill

NMMA-certified for safety
Safety engine stop switch

Wakeboarding and Water Ski Performance

Adjustable, oversized convex mirror with bracket, removable
USA Water Ski-approved
Parabolic tracking fins
Side panel ski storage
Swing-open center seat for walk-thru
Two (2) tournament speedometers
Wear-Guard polished chrome ski pylon, patented



On-water quality assurance testing of every boat
Precision Touch II rack-and-pinion steering system
Rigid PVC rub rail with vinyl insert
Stainless steel interior bow hand rails
Stainless steel upholstery staples
Steel-reinforced molds
Stern eyes
Transferable hull-and-structural components limited lifetime warranty
Wiring harness with color-coded and labeled wires—meets ABYC standards
Vinyl—34 oz. premium grade with UV protection and mildew resisters, UV-protected threads

Safety

Automatic/manual bilge pump system
Bilge blower
Engine warning light and alarm
Fire extinguisher
Flotation exceeding USCG requirements
Horn
Inland lighting

Optional Equipment

Propulsion and Systems

MasterCraft Power Vortec Cadillac LQ9 HO 6.0L multi-port EFI V-8 engine—385 hp
MasterCraft Power Vortec L18 HO 8.1L EFI 496-inch GM V-8 engine—425 hp
1.5:1 gear ratio patented PowerSlot package (includes 4-blade 14x18 propeller)
Closed cooling system (not available with shower, standard with Cadillac LQ9 engine)
European package
Hood scoop (available with medium motor box)

Canvas and Carpet

Bimini top (dealer-installed)
Bow tonneau cover (dealer-installed)
Cockpit mooring cover (dealer-installed)
Sun top (dealer-installed)
Towable boat cover
Towable boat cover for tower

197

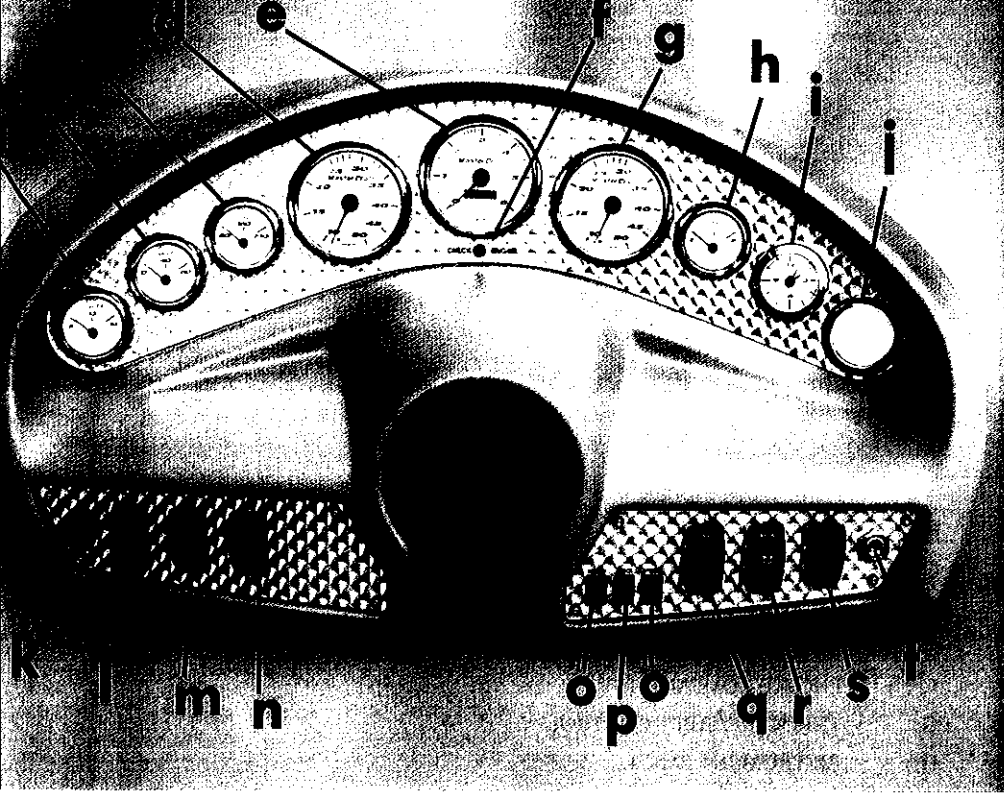

Comfort and Convenience

- Clarion AM/FM CD stereo system with four marine speakers with digital read-out remote on instrument panel
- Clarion AM/FM CD stereo system with subwoofer and high-power amp (500 watts) with digital read-out remote on instrument panel
- Clarion 6-disc CD changer
- Clarion transom-mounted stereo digital read-out remote control
- Depth finder
- Fiberglass swim platform—removable, available in all gel colors
- Heater
- Pressurized hot/cold shower (not available with closed cooling system)
- Pull-up cleats for bow (stainless, flush-mounted)
- Pull-up cleats for stern (stainless, flush-mounted)

Construction

- Extended warranty
- Custom gel coat
- Metal flake gel coat
- Rearrangement of upholstery colors

Wakeboarding and Water Ski Performance

- MasterCraft Training System (MTS)
- Rear Ballast System
- Both MTS and Rear Ballast System
- Perfect Pass Digital Pro
- Perfect Pass Cruise
- Perfect Pass Wakeboard Edition
- Binding Blaster soap pump
- Teak transom saver (not available with fiberglass swim platform)

- Tournament KPH speedometers (two—no-charge option)
- Water temperature gauge (in place of clock)
- ZeroFlex Flyer mini-tower with board or slalom racks (two sides)
- Slalom rack (one side)
- Clarion tower speakers (150 watts each) with amp
- Two sets of tower speakers
- Two sets of speakers with lights (kit includes two lights/four speakers)
- Tower light bar with four lights (either two forward and two aft, or four aft)

Trailers

- Canadian-approved trailer
- Galvanized single-axle trailer with disc brakes with swing-away tongue

- Galvanized tandem-axle trailer with disc brakes with swing-away tongue
- Single axle trailer with disc brakes with swing-away tongue
- Tandem axle trailer with disc brakes with swing-away tongue
- Spare trailer tire and wheel assembly (available aluminum or galvanized)

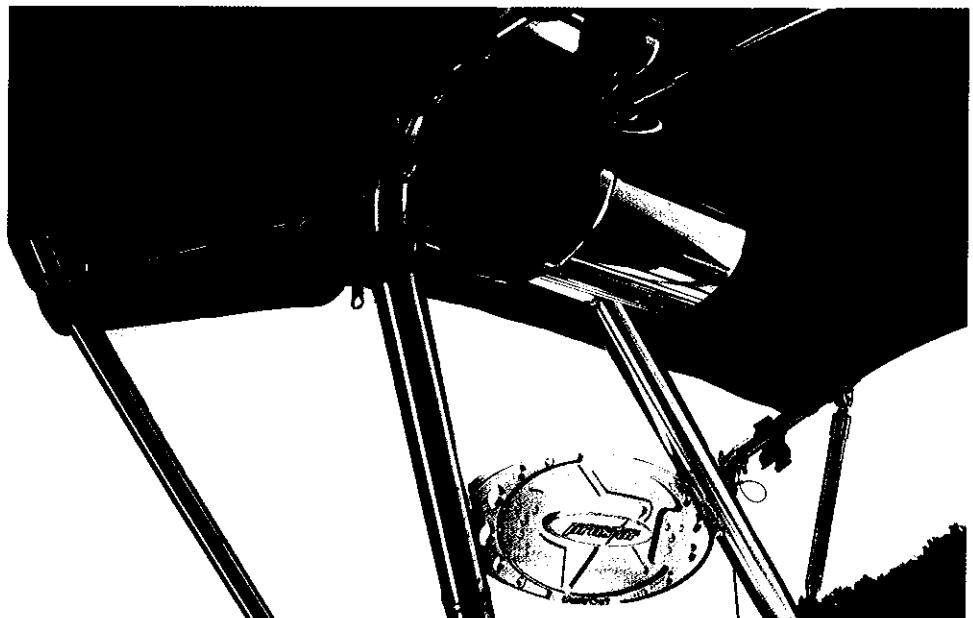

190

1900 cc V6 engine (200 HP)
1900 cc V6 engine (210 HP)
1900 cc V6 engine (220 HP)
1900 cc V6 engine (230 HP)
1900 cc V6 engine (240 HP)
1900 cc V6 engine (250 HP)
1900 cc V6 engine (260 HP)
1900 cc V6 engine (270 HP)
1900 cc V6 engine (280 HP)
1900 cc V6 engine (290 HP)
1900 cc V6 engine (300 HP)
1900 cc V6 engine (310 HP)
1900 cc V6 engine (320 HP)
1900 cc V6 engine (330 HP)
1900 cc V6 engine (340 HP)
1900 cc V6 engine (350 HP)

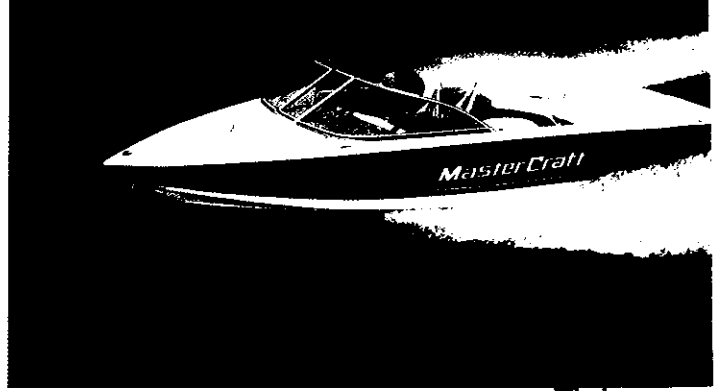

LAYOUT

- A FUEL TANK FILLER
- B BLOWER EXHAUST
- C SWIM PLATFORM
- D STERN LIGHT RECEPTACLE
- E STORAGE UNDER SUN PAD
- F ENGINE COMPARTMENT
- G THROTTLE/SHIFT CONTROL
- H INSTRUMENT PANEL
- I BOW LIGHT
- J GLOVE BOX
- K BATTERY (UNDER SEAT)
- L FIRE EXTINGUISHER (BEHIND SEAT)
- M DRAIN PLUG

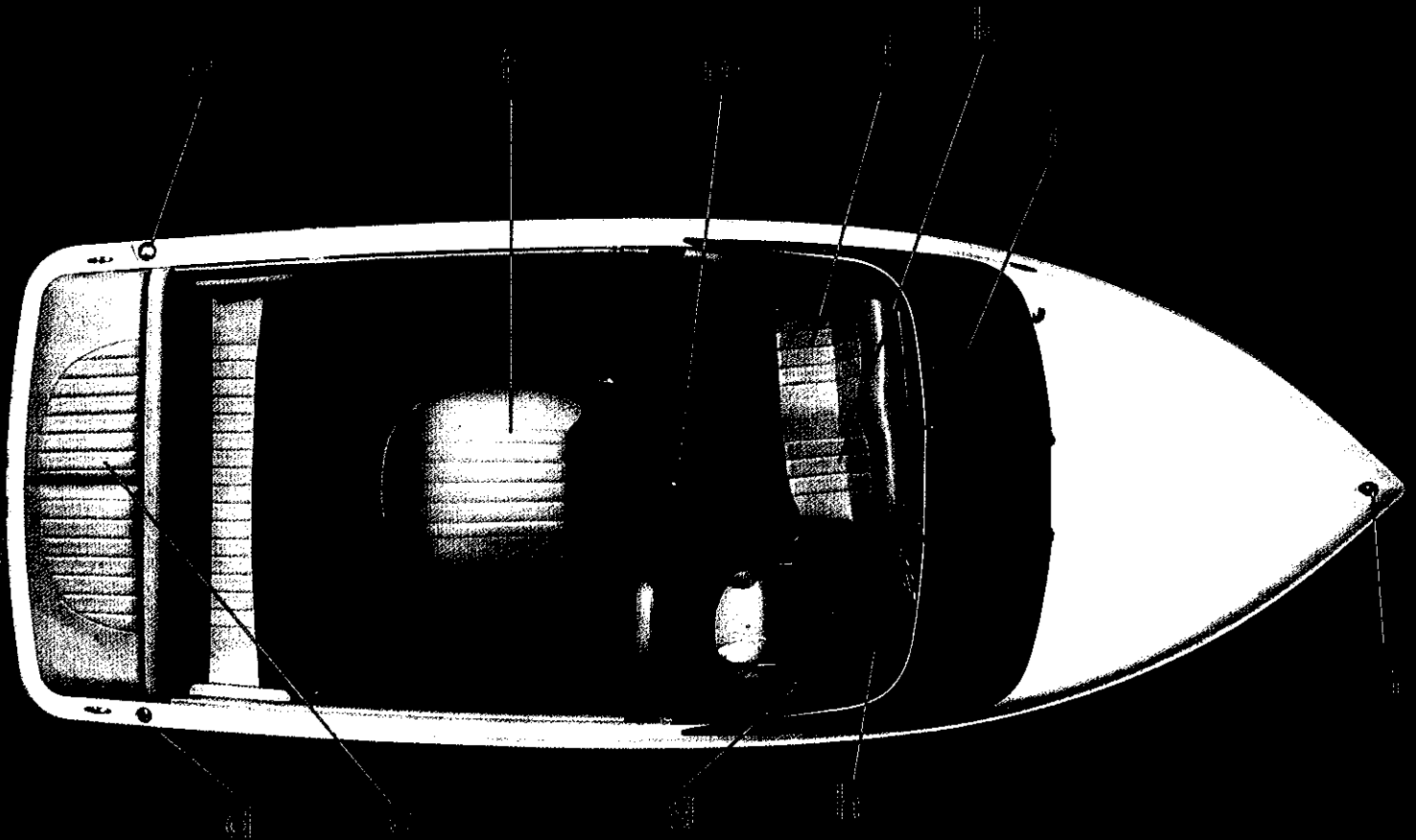

The MasterCraft Movement

The 190



Standard Equipment

Propulsion and Systems

MasterCraft Power Vortec Predator 5.7L EFI TBI
350-cubic-inch GM V-8 engine—310 hp
1:1 gear ratio transmission
4-blade 13-inch propeller
3-year limited engine warranty
Competition throttle control
Dual exhaust system
Dual fuel filtration system
Engine temperature gauge
EZ Change oil kit
Fuel gauge
High-pressure in-tank fuel pump
Low-battery voltage alarm
Oil pressure gauge
Silent Master muffler/exhaust system
Tachometer with hourmeter
Voltmeter

Comfort and Convenience

Two (2) 12-volt DC power outlets
Built-in cooler with drain
Center drain with threaded drain plug
Chronograph clock
Custom polished aluminum steering wheel,
ergonomically designed
Six (6) drink holders
MasterView driver's seat
Gas-filled lifts for motor box cover
Glove box, water-resistant, space for stereo
Observer's seat—aft facing (*fits 3 people*)
Illuminated lockable storage behind
observer's seat
Rear seat converts to three-person sun pad
Recessed floor area with drain—driver's
area
Removable lower rear seat cushion
Storage under sun pad, illuminated
Sun pad—full access, split deck
Teak swim platform, removable
Tilt steering wheel
Two-piece fully insulated motor box

Construction

All hand-laid fiberglass construction
All stainless steel and non-corrosive
hardware
Aluminum floorboards
AnchorLok reinforcing plates, steel, aluminum,
or HDPE, on all key parts
Bow eye, stainless steel
CelMaster reticulated dry-foam seat
construction
Circuit breakers
Cross-linked polyethylene fuel cell
Curved tempered safety glass windshield
Drip-molded decals
Exclusive splined propeller and propeller
shaft with lock nut
Gel coat tolerances to +/- .005"
Heavy-duty 40 oz. Marine carpet with 5-
year limited warranty
Integrated gel coat striping

M.O.D.S. MasterCraft Oscillation Dampening
System for noise and vibration reduction
Magnesium bronze rudder box with o-rings
and grease fittings
Magnesium bronze rudder with 1-1/8"
stainless steel shaft
Magnesium bronze strut with 8-bolt mounting
and dual bearings
MasterCraft custom steering connection with
grease fittings
MasterCraft electromechanical custom
gauges
Monocoque integrated stringer system
No-spill gas fill
On-water quality assurance testing of every boat
Precision Touch II rack-and-pinion steering
system
Rigid PVC rub rail with vinyl insert

Wakeboarding and Water Ski Performance

Adjustable, oversized convex mirror with
bracket, removable
USA Water Ski-approved
EVO Evolution Hull
Parabolic tracking fins
Side panel ski storage
Two (2) tournament speedometers
Wear-Guard anodized aluminum ski pylon,
patented

Optional Equipment

Propulsion and Systems

MasterCraft Power Vortec MCX 5.7L multi-
port EFI 350-cubic-inch GM V-8 engine—
350 hp

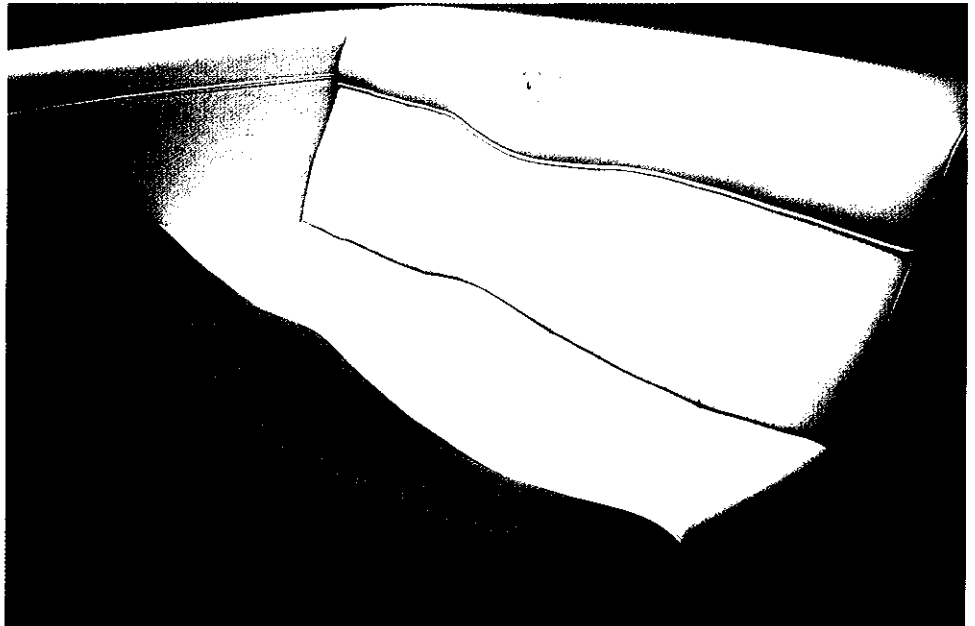

Stainless steel upholstery staples
Steel-reinforced molds
Stern eyes
Transferable hull-and-structural components
limited lifetime warranty
Wiring harness with color-coded and
labeled wires—meets ABYC standards
Vinyl—34 oz. premium grade with UV
protection and mildew resistors, UV-
protected threads

Safety

Automatic/manual bilge pump system
Bilge blower
Engine warning light and alarm
Fire extinguisher
Flotation exceeding USCG requirements
Horn
Inland lighting
NMMA-certified for safety
Safety engine stop switch

MasterCraft Power Vortec Cadillac LQ9 HO
6.0L multi-port EFI V-8 engine—385 hp
MasterCraft Power Vortec L18 HO 8.1L EFI
496-inch GM V-8 engine—425 hp
1.5:1 gear ratio patented PowerSlot
package (includes 4-blade 14x18
propeller)
Closed cooling system (not available with
shower, standard with Cadillac LQ9 engine)
European package
Hood scoop (available with medium motor
box)

Canvas and Carpet

Bimini top (dealer-installed)
Cockpit mooring cover (dealer-installed)
Sun top (dealer-installed)
Towable boat cover
Towable boat cover for tower



Comfort and Convenience

- Clarion AM/FM CD stereo system with four marine speakers with digital read-out remote on instrument panel
- Clarion AM/FM CD stereo system with subwoofer and high-power amp (500 watts) with digital read-out remote on instrument panel
- Clarion 6-disc CD changer
- Clarion transom-mounted stereo digital read-out remote control
- Depth finder
- Fiberglass swim platform—removable, available in all gel colors
- Heater
- Pressurized hot/cold shower (not available with closed cooling system)
- Pull-up cleats for bow (stainless, flush-mounted)
- Pull-up cleats for stern (stainless, flush-mounted)

Construction

- Extended warranty
- Custom gel coat
- Metal flake gel coat
- Rearrangement of upholstery colors

Wakeboarding and Water Ski Performance

- MasterCraft Training System (MTS)
- Rear Ballast System
- Both MTS and Rear Ballast System
- Perfect Pass Digital Pro
- Perfect Pass Cruise
- Perfect Pass Wakeboard Edition
- Binding Blaster soap pump
- Teak transom saver (not available with fiberglass swim platform)

- Tournament KPH speedometers (two—no-charge option)
- Water temperature gauge (in place of clock)
- ZeroFlex Flyer mini-tower with board or slalom racks (two sides)
- Slalom rack (one side)
- Clarion tower speakers (150 watts each) with amp
- Two sets of tower speakers
- Two sets of speakers with lights (kit includes two lights/four speakers)
- Tower light bar with four lights (either two forward and two aft, or four aft)

Trailers

- Canadian-approved trailer

- Galvanized single-axle trailer with disc brakes with swing-away tongue
- Galvanized tandem-axle trailer with disc brakes with swing-away tongue
- Single axle trailer with disc brakes with swing-away tongue
- Tandem axle trailer with disc brakes with swing-away tongue



190

VELOCITEER SERIES

Length of Boat: 19'8"

Length of Boat with Platform: 21'6"

Width Amidship: 91"

Overall Length w/Trailer: 22'10"

W/swing-away tongue folded: 21'1"

Overall Width w/Trailer:

99" (single-axle)

100" (tandem-axle)

Boat Weight: 2,620 lbs. (approx.)

Single Axle Trailer Weight: 860 lbs.

Tandem Axle Trailer Weight: 1,040 lbs.

Fuel Capacity: 28 gallons

Depth at Transom: 20"

Depth Amidship: 22-1/2"

Draft: 22"

Tow Bar Height to Waterline: 29"

Capacity: 10 people or 1,340 lbs.



LAYOUT

- A FUEL TANK FILLER
- B BLOWER EXHAUST
- C SWIM PLATFORM
- D STERN LIGHT RECEPTACLE
- E STORAGE UNDER SUN PAD
- F ENGINE COMPARTMENT
- G THROTTLE/SHIFT CONTROL
- H INSTRUMENT PANEL
- I BOW LIGHT
- J GLOVE BOX
- K BATTERY (UNDER SEAT)
- L FIRE EXTINGUISHER (BEHIND SEAT)
- M DRAIN PLUG

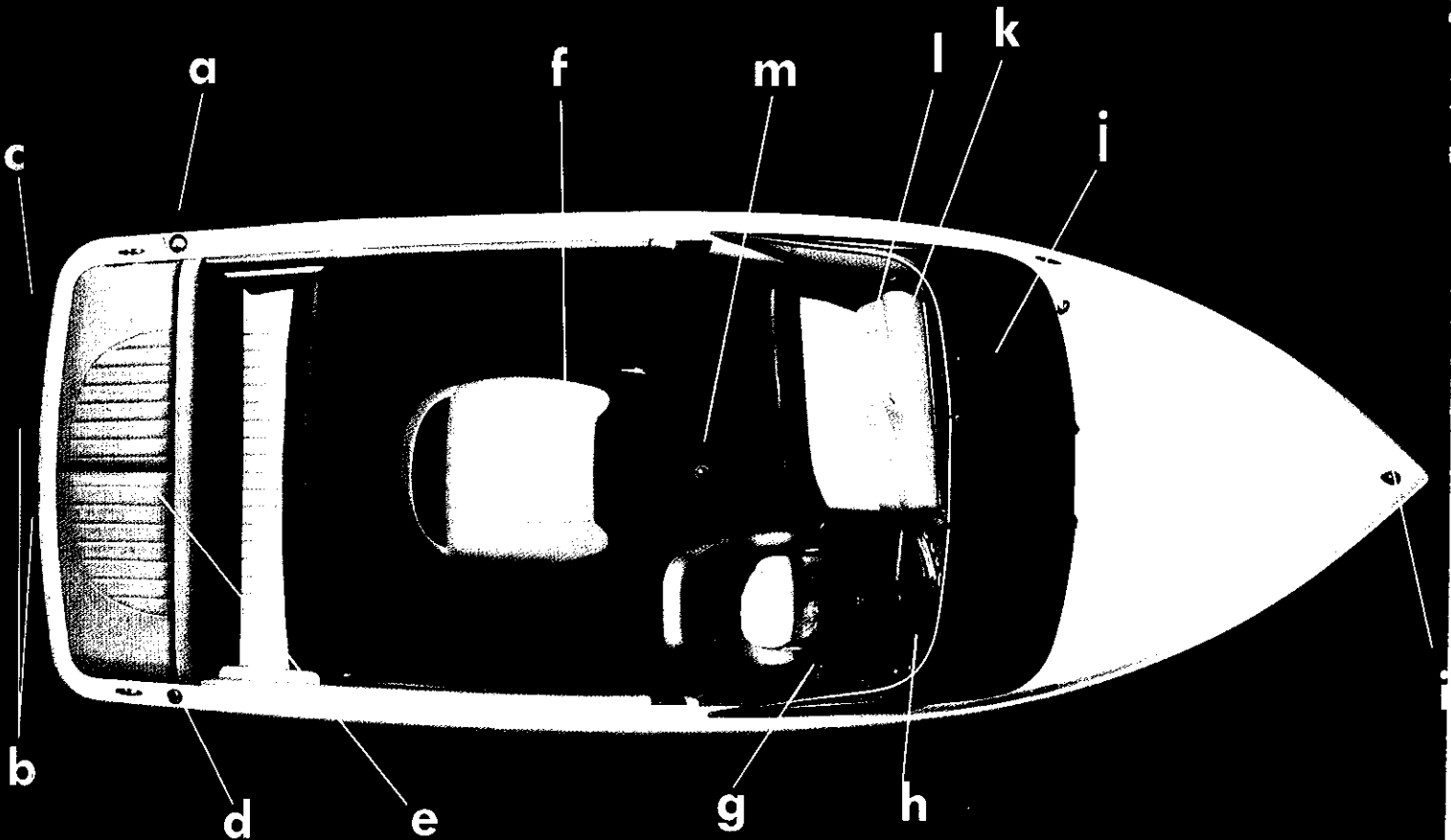

T H E P R O S T A R 1 9 0

S a m m y D u v a l l S i g n a t u r e S e r i e s

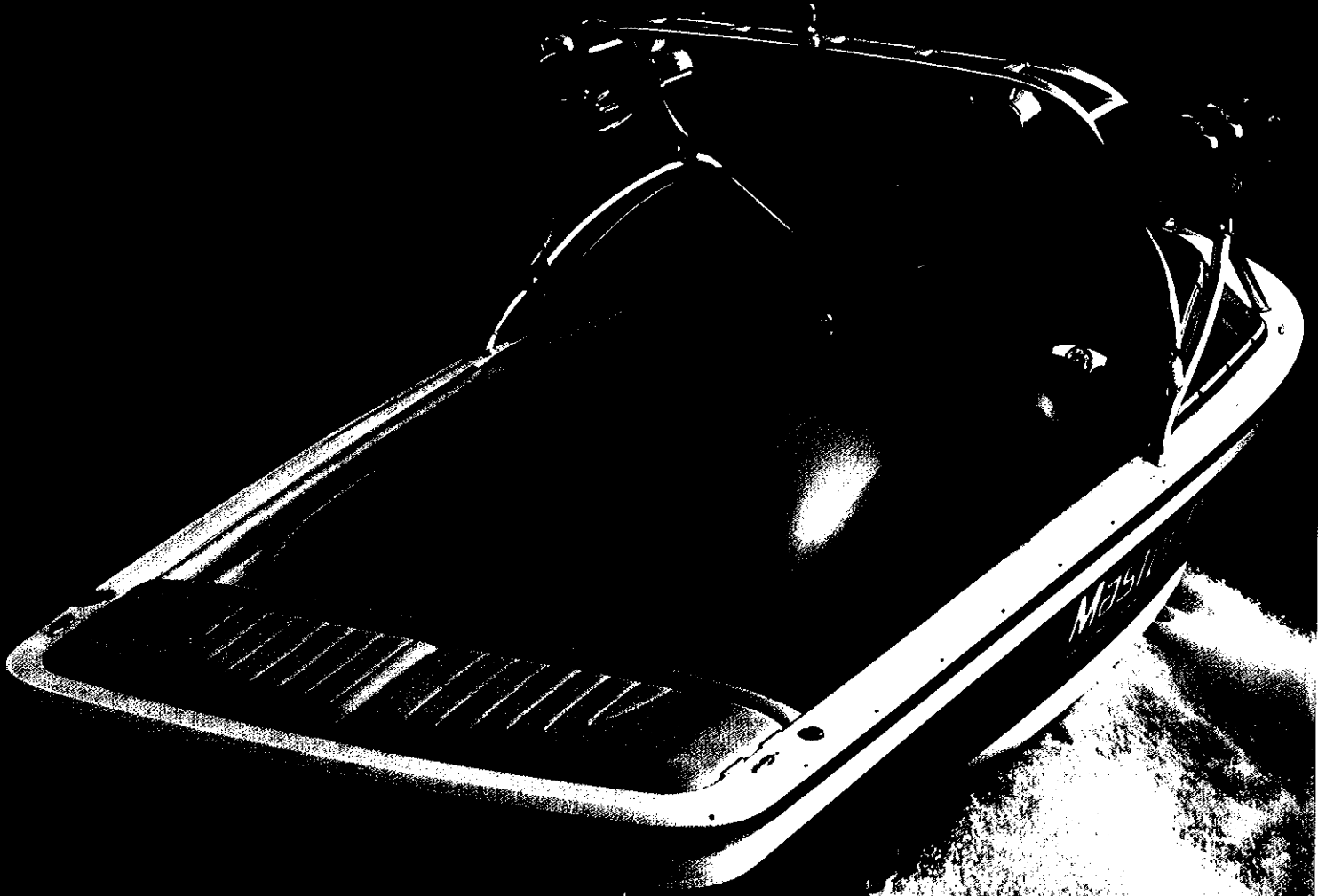

Standard Equipment

MasterCraft Power Vortec MCX 5.7L multi-port EFI 350 cubic-inch GM V-8 engine—350 hp

1:1 gear ratio transmission
4-blade 13-inch propeller
3-year limited engine warranty
Competition throttle control
Dual exhaust system
Dual fuel filtration system
Engine temperature gauge
EZ Change oil kit
Fuel gauge
High-pressure in-tank fuel pump
Low-battery voltage alarm
Oil pressure gauge
Silent Master muffler/exhaust system
Tachometer with hourmeter
Voltmeter

Two (2) 12-volt DC power outlets
Built-in cooler with drain
Center drain with threaded drain plug
Chronograph clock
Custom polished aluminum steering wheel, ergonomically designed
Six (6) drink holders
MasterView driver's seat
Gas-filled lifts for motor box cover
Glove box, water-resistant with space for stereo
Observer's seat—aft facing (fits 3 people)
Illuminated lockable storage behind observer's seat
Rear seat converts to three-person sun pad
Recessed floor area with drain—driver's area
Removable lower rear seat cushion
Storage under sun pad, illuminated
Sun pad—full access, split deck
Teak swim platform, removable
Tilt steering wheel
Two-piece fully insulated motor box

All hand-laid fiberglass construction
All stainless steel and non-corrosive hardware
Aluminum floorboards
AnchorLok reinforcing plates, steel, aluminum, or HDPE, on all key parts
Bow eye, stainless steel
CelMaster reticulated dry-foam seat construction
Circuit breakers
Cross-linked polyethylene fuel cell
Curved tempered safety glass windshield
Drip-molded decals, including Sammy Duvall Signature Series decal
Exclusive splined propeller and propeller shaft with lock nut
Gel coat tolerances to +/- .005"

Heavy-duty 40 oz. Marine carpet with 5-year limited warranty
Integrated gel coat striping
M.O.D.S. MasterCraft Oscillation Dampening System for noise and vibration reduction
Magnesium bronze rudder box with o-rings and grease fittings
Magnesium bronze rudder with 1-1/8" stainless steel shaft
Magnesium bronze strut with 8-bolt mounting and dual bearings
MasterCraft custom steering connection with grease fittings

Adjustable, oversized convex mirror with bracket, removable
USA Water Ski-approved
EVO Evolution Hull
Parabolic tracking fins
Side panel ski storage
Two (2) tournament speedometers
Wear-Guard polished chrome aluminum ski pylon, patented

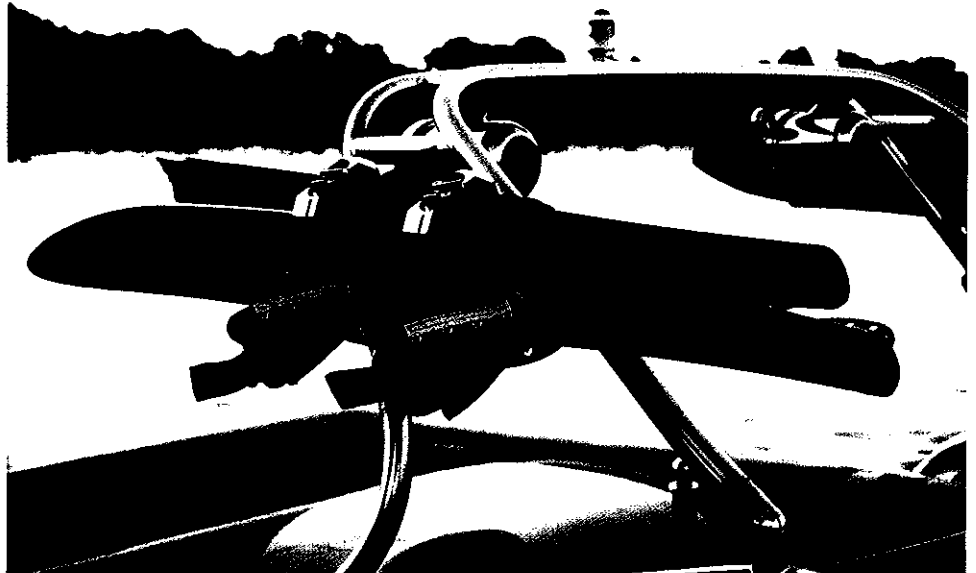

MasterCraft electromechanical custom gauges
Monocoque integrated stringer system
No-spill gas fill
On-water quality assurance testing of every boat
Precision Touch II rack-and-pinion steering system
Rigid PVC rub rail with vinyl insert
Stainless steel upholstery staples
Steel-reinforced molds
Stern eyes
Transferable hull-and-structural components limited lifetime warranty
Wiring harness with color-coded and labeled wires—meets ABYC standards
Vinyl—34 oz. Premium grade with UV protection and mildew resisters, UV-protected threads

Automatic/manual bilge pump system
Bilge blower
Engine warning light and alarm
Fire extinguisher
Flotation exceeding USCG requirements
Horn
inland lighting
NMMA-certified for safety
Safety engine stop switch

Optional Equipment

MasterCraft Power Vortec Cadillac LQ9 HO 6.0L multi-port EFI V-8 engine—385 hp
MasterCraft Power Vortec L18 HO 8.1L EFI 496-inch GM V-8 engine—425 hp
1.5:1 gear ratio patented PowerSlot package (includes 4-blade 14x18 propeller)
Closed cooling system (not available with shower, standard with Cadillac LQ9 engine)
European package
Hood scoop (available with medium motor box)

Bimini top (dealer-installed)
Cockpit mooring cover (dealer-installed)
Sun top (dealer-installed)
Towable boat cover
Towable boat cover for tower

Clarion AM/FM CD stereo system with four marine speakers with digital read-out remote on instrument panel

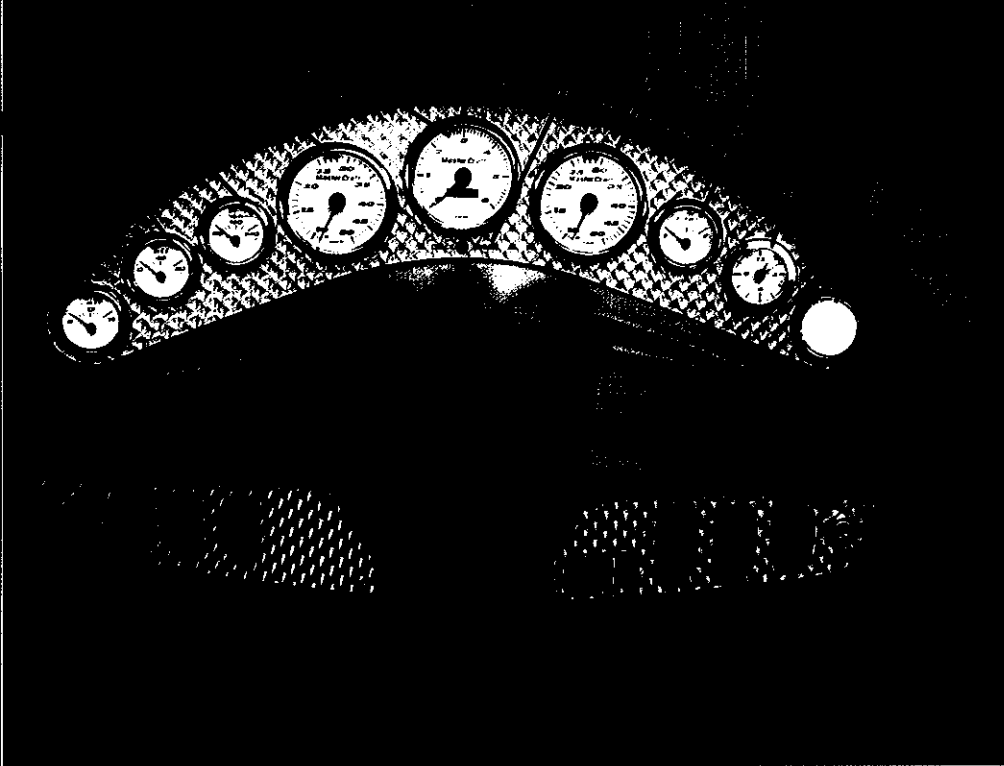

- Clarion AM/FM CD stereo system with subwoofer and high-power amp (500 watts) with digital read-out remote on instrument panel
- Clarion 6-disc CD changer
- Clarion transom-mounted stereo digital read-out remote control
- Depth finder
- Fiberglass swim platform—removable, available in all gel colors
- Heater
- Pressurized hot/cold shower (not available with closed cooling system)
- Pull-up cleats for bow (stainless, flush-mounted)
- Pull-up cleats for stern (stainless, flush-mounted)

- ZeroFlex Flyer mini-tower with board or slalom racks (two sides)
- Slalom rack (one side)
- Clarion tower speakers (150 watts each) with amp
- Two sets of tower speakers
- Two sets of speakers with lights (kit includes two lights/four speakers)
- Tower light bar with four lights (either two forward and two aft, or four aft)

- Single axle trailer with disc brakes with swing-away tongue
- Tandem axle trailer with disc brakes with swing-away tongue
- Spare trailer tire and wheel assembly (available aluminum or galvanized)

- Trailers**
- Canadian-approved trailer
 - Galvanized single-axle trailer with disc brakes with swing-away tongue
 - Galvanized tandem-axle trailer with disc brakes with swing-away tongue

- Construction**
- Extended warranty
 - Custom gel coat
 - Metal flake gel coat
 - Rearrangement of upholstery colors

- Options and Packages**
- MasterCraft Training System (MTS)
 - Rear Ballast System
 - Both MTS and Rear Ballast System
 - Perfect Pass Digital Pro
 - Perfect Pass Cruise
 - Perfect Pass Wakeboard Edition
 - Binding Blaster soap pump
 - Teak transom saver (not available with fiberglass swim platform)
 - Tournament KPH speedometers (two—no-charge option)
 - Water temperature gauge (in place of clock)



209



LAYOUT

- A FUEL TANK FILLER
- B BLOWER EXHAUST
- C SWIM PLATFORM
- D STERN LIGHT RECEPTACLE
- E STORAGE UNDER SUN PAD
- F ENGINE COMPARTMENT
- G THROTTLE/SHIFT CONTROL
- H INSTRUMENT PANEL
- I BOW LIGHT
- J GLOVE BOX
- K BATTERY (UNDER SEAT)
- L FIRE EXTINGUISHER (BEHIND SEAT)
- M DRAIN PLUG





Standard Equipment

Propulsion and Systems

MasterCraft Power Vortec Predator 5.7L EFI
TBI 350-cubic-inch GM V-8 engine—310 hp
1:1 gear ratio transmission
4-blade 13-inch propeller
3-year limited engine warranty
Competition throttle control
Dual exhaust system
Dual fuel filtration system
Engine temperature gauge
EZ Change oil kit
Fuel gauge
High-pressure in-tank fuel pump
Low-battery voltage alarm
Oil pressure gauge
Silent Master muffler/exhaust system
Tachometer with hourmeter
Voltmeter

Comfort and Convenience

Two (2) 12-volt DC power outlets
Built-in cooler with drain and ski storage locker
Center drain with threaded drain plug
Chronograph clock
Companionway walk-thru wind enclosure, canvas
Custom polished aluminum steering wheel, ergonomically designed
Eight (8) drink holders
MasterView driver's seat
Gas-filled lifts for motor box cover
Glove box, water-resistant with space for stereo
Observer's seat—aft facing
Illuminated lockable storage behind observer's seat
Rear seat converts to three-person sun pad
Recessed floor area with drain—driver's area
Removable lower rear seat cushion
Storage under sun pad, illuminated
Sun pad—full access, split deck
Teak swim platform, removable
Tilt steering wheel
Two-piece fully insulated motor box
Transom hand rail with integral tow loop

Construction

All hand-laid fiberglass construction
All stainless steel and non-corrosive hardware
Aluminum floorboards
AnchorLok reinforcing plates, steel, aluminum, or HDPE, on all key parts
Bow eye, stainless steel
CelMaster reticulated dry-foam seat construction
Circuit breakers
Cross-linked polyethylene fuel cell
Curved tempered safety glass windshield
Drip-molded decals

Exclusive splined propeller and propeller shaft with lock nut
Gel coat tolerances to +/- .005"
Heavy-duty 40 oz. marine carpet with 5-year limited warranty
Integrated gel coat striping
M.O.D.S. MasterCraft Oscillation Dampening System for noise and vibration reduction
Magnesium bronze rudder box with o-rings and grease fittings
Magnesium bronze rudder with 1-1/8" stainless steel shaft
Magnesium bronze strut with 8-bolt mounting and dual bearings
MasterCraft custom steering connection with grease fittings

Flotation exceeding USCG requirements
Horn
Inland lighting
NMMA-certified for safety
Safety engine stop switch

Wakeboarding and Water Ski Performance

Adjustable, oversized convex mirror with bracket, removable
USA Water Ski-approved
Parabolic tracking fins
Side panel ski storage
Two (2) tournament speedometers
Wear-Guard anodized aluminum ski pylon, patented



MasterCraft electromechanical custom gauges
Monocoque integrated stringer system
No-spill gas fill
On-water quality assurance testing of every boat
Precision Touch II rack-and-pinion steering system
Rigid PVC rub rail with vinyl insert
Stainless steel bow hand rails
Stainless steel upholstery staples
Stern eyes
Transferable hull-and-structural components limited lifetime warranty
Wiring harness with color-coded and labeled wires—meets ABYC standards
Vinyl—34 oz. premium grade with UV protection and mildew resisters, UV-protected threads

Safety

Automatic/manual bilge pump system
Bilge blower
Engine warning light and alarm
Fire extinguisher

Optional Equipment

Propulsion and Systems

MasterCraft Power Vortec MCX 5.7L multi-port EFI 350-cubic-inch GM V-8 engine—350 hp
MasterCraft Power Vortec Cadillac LQ9 HO 6.0L multi-port EFI V-8 engine—385 hp
MasterCraft Power Vortec L18 HO 8.1L EFI 496-inch GM V-8 engine—425 hp
1.5:1 gear ratio patented PowerSlot package (includes 4-blade 14x18 propeller)
Closed cooling system (not available with shower, standard with Cadillac LQ9 engine)
European package
Hood scoop (available with medium motor box)

Canvas and Carpet

Bimini top (dealer-installed)
Bow tonneau cover (dealer-installed)
Cockpit mooring cover (dealer-installed)
Sun top (dealer-installed)

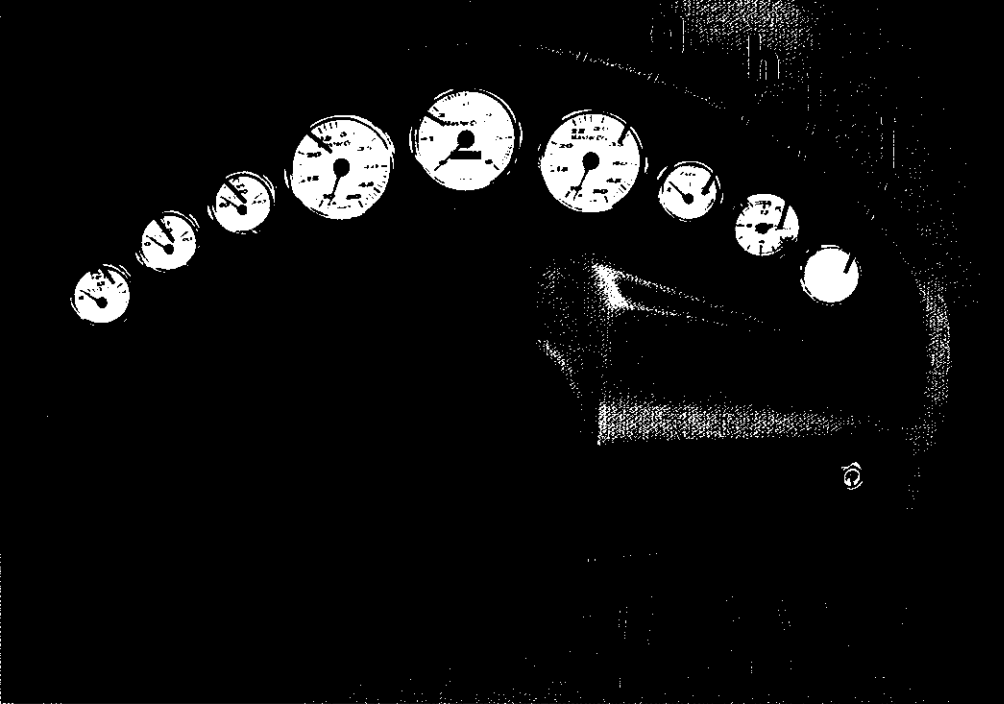

- Towable boat cover
- Towable boat cover for tower

Comfort and Convenience

- Bow filler cushion
- Clarion AM/FM CD stereo system with four marine speakers, with digital read-out remote on instrument panel
- Clarion AM/FM CD stereo system with subwoofer and high-power amp (500 watts) with digital read-out remote on instrument panel
- Clarion 6-disc CD changer
- Clarion transom-mounted stereo digital read-out remote control
- Depth finder
- Fiberglass swim platform—removable, available in all gel colors
- Heater
- Pressurized hot/cold shower (not available with closed cooling system)
- Pull-up cleats for bow (stainless, flush-mounted)
- Pull-up cleats for stern (stainless, flush-mounted)

Construction

- Extended warranty
- Custom gel coat
- Metal flake gel coat
- Rearrangement of upholstery colors

Wakeboarding and Water Ski Performance

- Perfect Pass Pro Series
- Perfect Pass Cruise
- Perfect Pass Wakeboard Edition
- Binding Blaster soap pump
- KGB system including saddle tanks
- Removable center seat for walk-thru

- Teak transom saver (not available with fiberglass swim platform)
- Tournament KPH speedometers (two—no-charge option)
- Water temperature gauge (in place of clock)
- ZeroFlex Flyer tower with board racks (two sides)
- Slalom rack (one side)
- Clarion tower speakers (150 watts each) with amp
- Two sets of tower speakers
- Two sets of speakers with lights (kit includes two lights/four speakers)
- Tower light bar with four lights (either two forward and two aft, or four aft)

Trailers

- Canadian-approved trailer
- Galvanized single-axle trailer with disc brakes with swing-away tongue
- Galvanized tandem-axle trailer with disc brakes with swing-away tongue
- Single axle trailer with disc brakes with swing-away tongue
- Tandem axle trailer with disc brakes with swing-away tongue

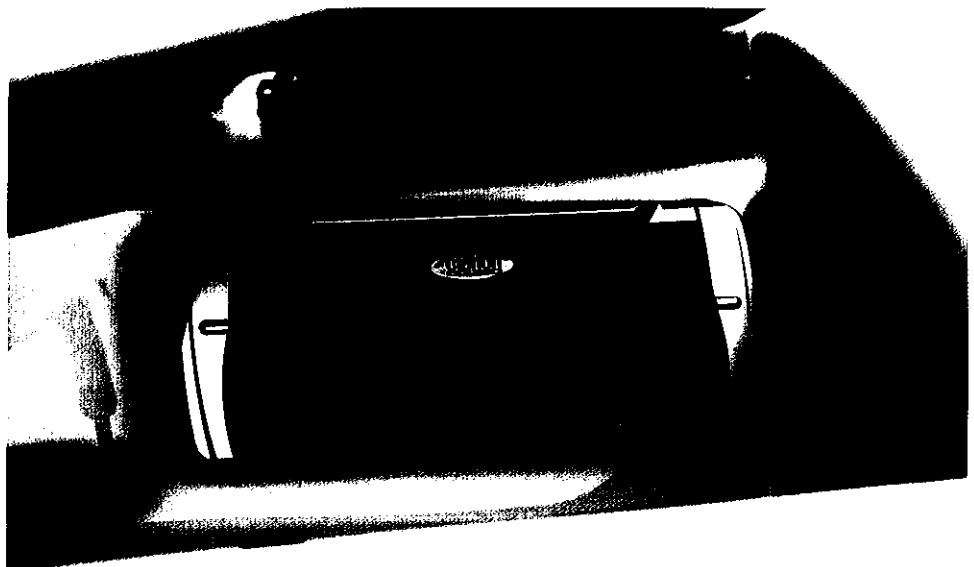

209

Length of Boat: 20' 11-1/2"

Length of Boat with Platform: 22' 9-1/2"

Width Amidship: 96"

Overall Length w/Trailer: 23'1"

W/swing-away tongue folded: 21'4"

Overall Width w/Trailer: 100"

Boat Weight: 2,850 lbs. (approx.)

Single Axle Trailer Weight: 900 lbs.

Tandem Axle Trailer Weight: 1050 lbs.

Fuel Capacity: 35 gallons

Depth at Transom: 23"

Depth Amidship: 25-1/2"

Draft: 22"

Tow Bar Height to Waterline: 29"

Capacity: 12 people or 1,705 lbs.

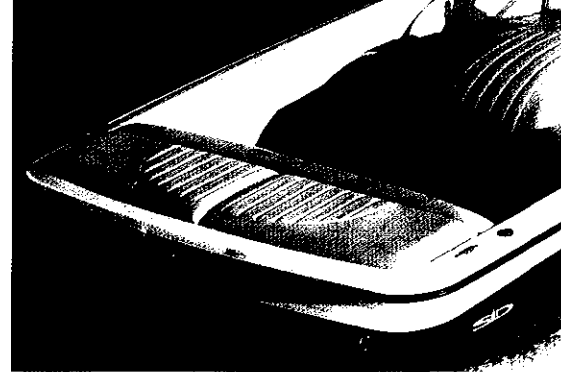

LAYOUT

- A FUEL TANK FILLER
- B BLOWER EXHAUST
- C SWIM PLATFORM
- D STERN LIGHT RECEPTACLE
- E STORAGE UNDER SUN PAD
- F ENGINE COMPARTMENT
- G THROTTLE/SHIFT CONTROL
- H INSTRUMENT PANEL
- I BOW LIGHT
- J GLOVE BOX
- K BATTERY (UNDER SEAT)
- L FIRE EXTINGUISHER (BEHIND SEAT)
- M DRAIN PLUG

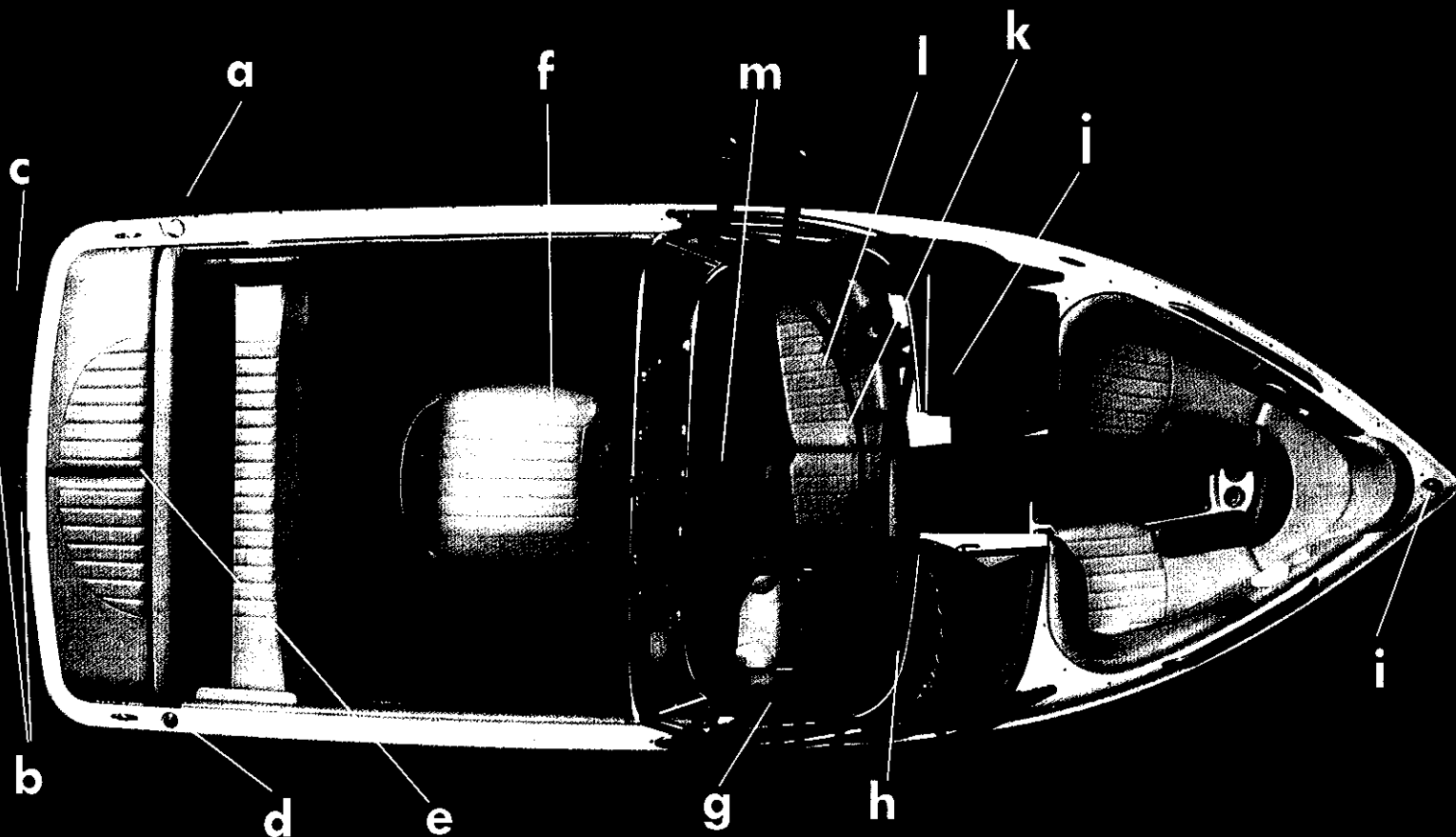

The MasterCraft Movement

The PROSTAR 209

Sammy Duvall Signature Series



Standard Equipment

MasterCraft Power Vortec MCX 5.7L multi-port EFI 350-cubic-inch GM V-8 engine—350 hp

1:1 gear ratio transmission
4-blade 13-inch propeller
3-year limited engine warranty
Competition throttle control
Dual exhaust system
Dual fuel filtration system
Engine temperature gauge
EZ Change oil kit
Fuel gauge
High-pressure in-tank fuel pump
Low-battery voltage alarm
Oil pressure gauge
Silent Master muffler/exhaust system
Tachometer with hourmeter
Voltmeter

Two (2) 12-volt DC power outlets
Built-in cooler with drain and ski storage locker
Center drain with threaded drain plug
Chronograph clock
Companionway walk-thru wind enclosure, canvas
Custom polished aluminum steering wheel, ergonomically designed
Eight (8) drink holders
MasterView driver's seat
Gas-filled lifts for motor box cover
Glove box, water-resistant with space for stereo
Observer's seat—aft facing
Illuminated lockable storage behind observer's seat
Rear seat converts to three-person sun pad
Recessed floor area with drain—driver's area
Removable lower rear seat cushion
Storage under sun pad, illuminated
Sun pad—full access, split deck
Teak swim platform, removable
Tilt steering wheel
Two-piece fully insulated motor box
Transom hand rail with integral tow loop

All hand-laid fiberglass construction
All stainless steel and non-corrosive hardware
Aluminum floorboards
AnchorLok reinforcing plates, steel, aluminum, or HDPE, on all key parts
Bow eye, stainless steel
CelMaster reticulated dry-foam seat construction
Circuit breakers
Cross-linked polyethylene fuel cell
Curved tempered safety glass windshield
Drip-molded decals, including Sammy Duvall Signature Series decals

Exclusive splined propeller and propeller shaft with lock nut
Gel coat tolerances to +/- .005"
Heavy-duty 40 oz. marine carpet with 5-year limited warranty
Integrated gel coat striping
M.O.D.S. MasterCraft Oscillation Dampening System for noise and vibration reduction
Magnesium bronze rudder box with o-rings and grease fittings
Magnesium bronze rudder with 1-1/8" stainless steel shaft
Magnesium bronze strut with 8-bolt mounting and dual bearings
MasterCraft custom steering connection with grease fittings

Flotation exceeding USCG requirements
Horn
Inland lighting
NMMA-certified for safety
Safety engine stop switch

Adjustable, oversized convex mirror with bracket, removable
USA Water Ski-approved
Parabolic tracking fins
Side panel ski storage
Two (2) tournament speedometers
Wear-Guard polished chrome ski pylon, patented

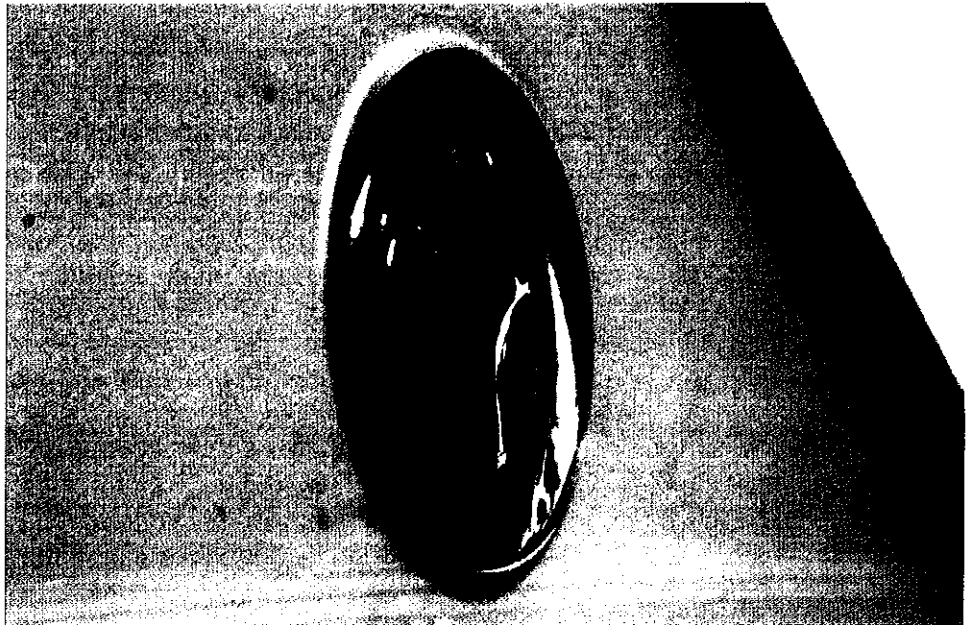

MasterCraft electromechanical custom gauges
Monocoque integrated stringer system
No-spill gas fill
On-water quality assurance testing of every boat
Precision Touch II rack-and-pinion steering system
Rigid PVC rub rail with vinyl insert
Stainless steel bow hand rails
Stainless steel upholstery staples
Stern eyes
Transferable hull-and-structural components limited lifetime warranty
Wiring harness with color-coded and labeled wires—meets ABYC standards
Vinyl—34 oz. premium grade with UV protection and mildew resistors, UV-protected threads

Automatic/manual bilge pump system
Bilge blower
Engine warning light and alarm
Fire extinguisher

Optional Equipment

MasterCraft Power Vortec Cadillac LQ9 HO 6.0L multi-port EFI V-8 engine—385 hp
MasterCraft Power Vortec L18 HO 8.1L EFI 496-inch GM V-8 engine—425 hp
1.5:1 gear ratio patented PowerSlot package (includes 4-blade 14x18 propeller)
Closed cooling system (not available with shower, standard with Cadillac LQ9 engine)
European package
Hood scoop (available with medium motor box)

Bimini top (dealer-installed)
Bow tonneau cover (dealer-installed)
Cockpit mooring cover (dealer-installed)
Sun top (dealer-installed)
Towable boat cover
Towable boat cover for tower

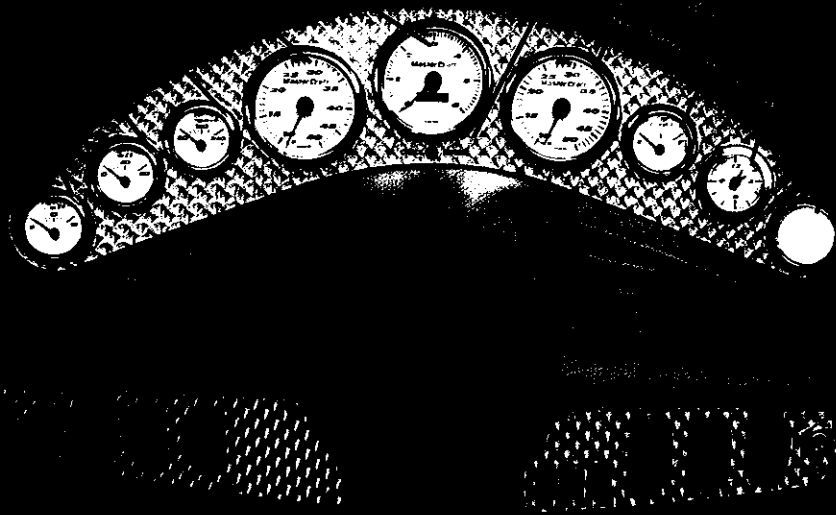

Standard Equipment

- Bow filler cushion
- Clarion AM/FM CD stereo system with four marine speakers with digital read-out remote on instrument panel
- Clarion AM/FM CD stereo system with subwoofer and high-power amp (500 watts) with digital read-out remote on instrument panel
- Clarion 6-disc CD changer
- Clarion transom-mounted stereo digital read-out remote control
- Depth finder
- Fiberglass swim platform—removable, available in all gel colors
- Heater
- Pressurized hot/cold shower (not available with closed cooling system)
- Pull-up cleats for bow (stainless, flush-mounted)
- Pull-up cleats for stern (stainless, flush-mounted)

Optional Equipment

- Extended warranty
- Custom gel coat
- Metal flake gel coat
- Rearrangement of upholstery colors

Accessories

- Perfect Pass Pro Series
- Perfect Pass Cruise
- Perfect Pass Wakeboard Edition
- Binding Blaster soap pump
- KGB system including saddle tanks
- Removable center seat for walk-thru
- Teak transom saver (not available with fiberglass swim platform)

- Tournament KPH speedometers (two—no-charge option)
 - Water temperature gauge (in place of clock)
 - ZeroFlex Flyer tower with board racks (two sides)
 - Slalom rack (one side)
 - Clarion tower speakers (150 watts each) with amp
 - Two sets of tower speakers
 - Two sets of speakers with lights (kit includes two lights/four speakers)
 - Tower light bar with four lights (either two forward and two aft, or four aft)
- Trailers:**
- Canadian-approved trailer
 - Galvanized single-axle trailer with disc brakes with swing-away tongue

- Galvanized tandem-axle trailer with disc brakes with swing-away tongue
- Single axle trailer with disc brakes with swing-away tongue
- Tandem axle trailer with disc brakes with swing-away tongue
- Spare trailer tire and wheel assembly (available aluminum or galvanized)



MARISA 210

VRS

Length of Boat: 20' 9"

Length of Boat with Platform: 22' 6"

Width Amidship: 95"

Overall Length w/Trailer: 22' 11"

W/swing-away tongue folded: 21' 2"

Overall Width w/Trailer:

98" (single-axle)

100" (tandem-axle)

Boat Weight: 3,075 lbs. (approx.)

Single Axle Trailer Weight: 900 lbs.

Tandem Axle Trailer Weight: 1,050 lbs.

Fuel Capacity: 45 gallons

Depth at Transom: 27-1/2"

Depth Amidship: 26-1/2"

Draft: 22-1/2"

Capacity: 11 people or 1,620 lbs.



LAYOUT

- A STERN LIGHT RECEPTACLE
- B BLOWER EXHAUST
- C SWIM PLATFORM
- D FUEL TANK FILLER
- E STORAGE UNDER SUN PAD
- F BATTERY (BEHIND SEAT)
- G THROTTLE/SHIFT CONTROL
- H INSTRUMENT PANEL
- J BOW LIGHT
- J GLOVE BOX
- K FIRE EXTINGUISHER (BEHIND SEAT)
- L SKI LOCKER
- M ENGINE COMPARTMENT

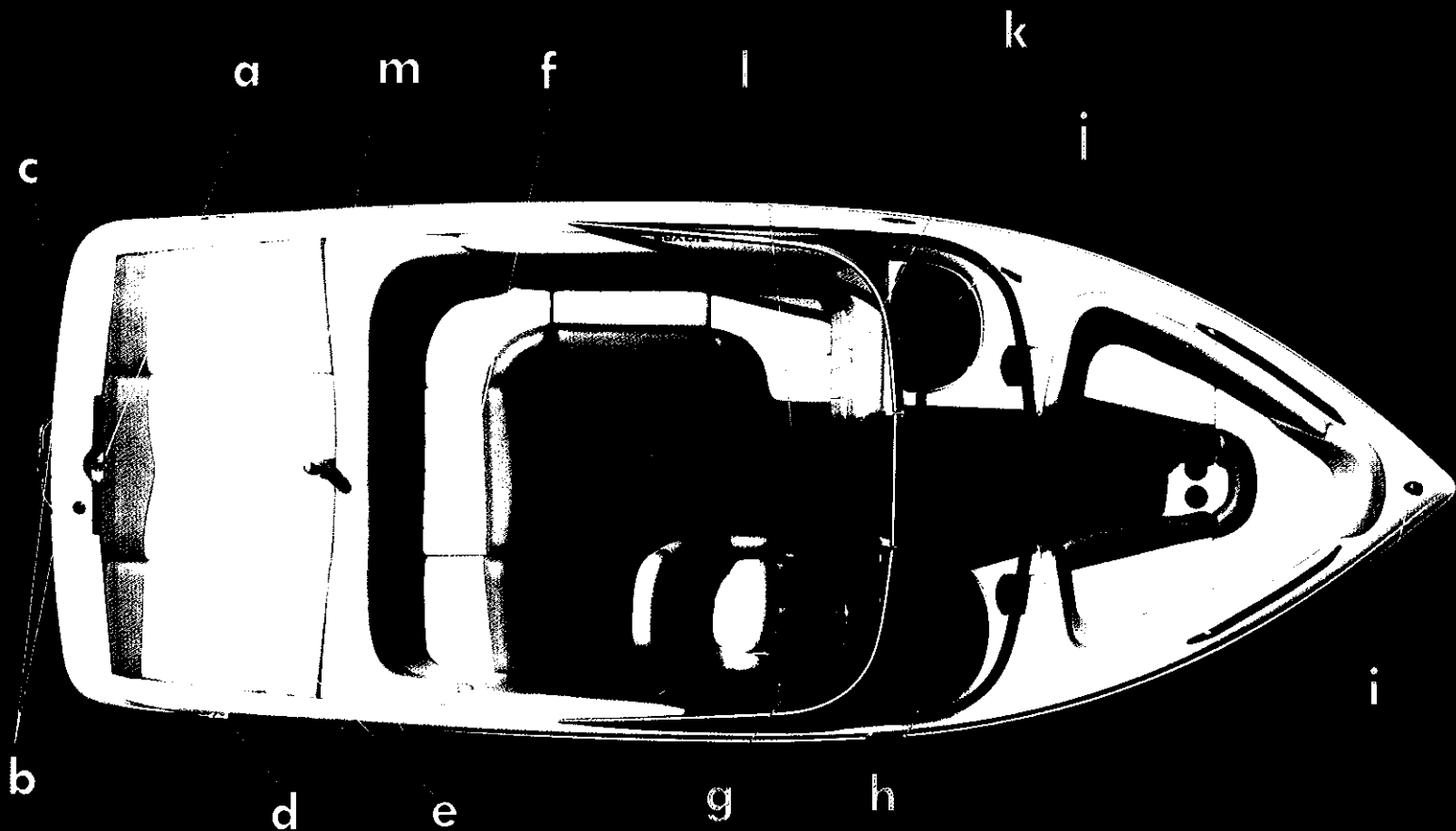

The M A R I S T A R 210



Standard Equipment

Propulsion and Systems

MasterCraft Power Vortec Predator 5.7L EFI
TBI 350-cubic-inch GM V-8 engine—310 hp
1.56:1 gear ratio transmission
4-blade 14-inch propeller, right-hand rotation
3-year limited engine warranty
Competition throttle control
Dual exhaust system
Dual fuel filtration system
Engine temperature gauge
EZ Change oil kit
Fuel gauge
High-pressure in-tank fuel pump
Low-battery voltage alarm
Oil pressure gauge
Silent Master muffler/exhaust system
Tachometer with hourmeter
Voltmeter

Comfort and Convenience

Two (2) 12-volt DC power outlets
Center drain with threaded drain plug
Clarion AM/FM CD stereo system with four marine speakers, with remote
Companionway walk-thru wind enclosure, canvas
Custom steering wheel, ergonomically designed
Custom dash
Depth finder
Drink holders
MasterView driver's seat
Driver's side armrest
Driver's side storage tray
Glove box
Observer's seat—aft facing
Storage under bow seating
Storage under sun pad, illuminated
Sun pad, three-piece
Teak swim platform, removable
Tilt steering wheel
Transom drain plug
Transom hand rail with integral tow loop

Construction

All hand-laid fiberglass construction
All stainless steel and non-corrosive hardware
Aluminum floorboards
AnchorLok reinforcing plates, steel, aluminum, or HDPE, on all key parts
Bow eye, stainless steel
CelMaster reticulated dry-foam seat construction
Circuit breakers
Cross-linked polyethylene fuel cell
Curved tempered safety glass windshield
Dripless shaft seal system
Exclusive splined propeller and propeller shaft with lock nut

Gel coat tolerances to +/- .005"
Heavy-duty 40 oz. marine carpet with 5-year limited warranty
Insulated and vented engine compartment
Integrated gel coat striping
M.O.D.S. MasterCraft Oscillation Dampening System for noise and vibration reduction
Magnesium bronze rudder box with o-rings and grease fittings
Magnesium bronze rudder with 1-1/8" stainless steel shaft

Safety

Bilge blower
Engine warning light and alarm
Fire extinguisher
Flotation exceeding USCG requirements
Fully automatic bilge pump system with manual override
Horn
Inland lighting
NMMA-certified for safety
Safety engine stop switch

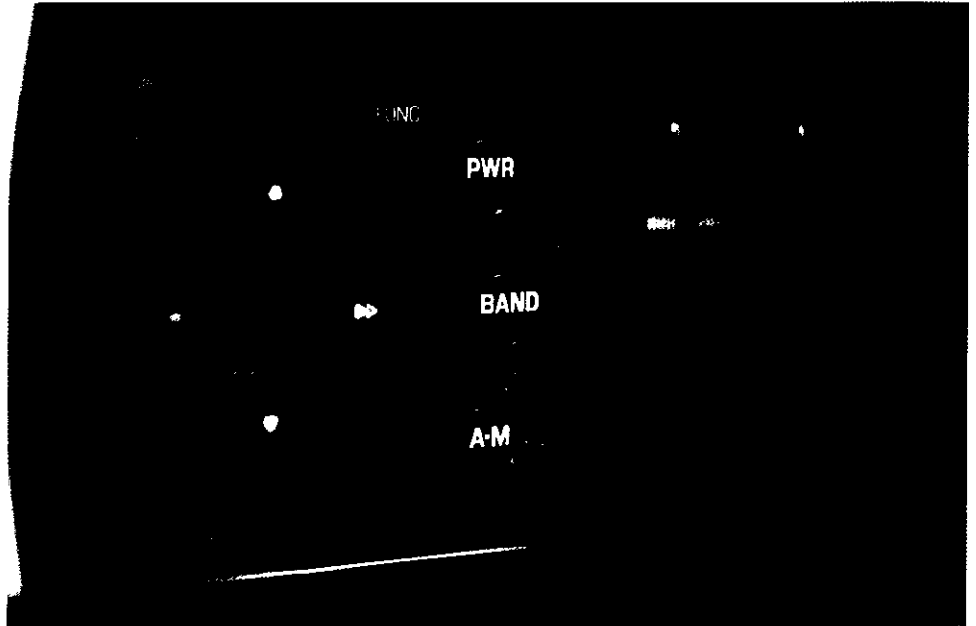

Magnesium bronze strut with 8-bolt mounting and dual bearings
MasterCraft custom steering connection with grease fittings
MasterCraft electromechanical custom gauges
Monocoque integrated stringer system
No-spill gas fill
On-water quality assurance testing of every boat
Precision Touch II rack-and-pinion steering system
Pull-up cleats
Pop-up cleats
Rigid PVC rub rail with vinyl insert
Stainless steel bow hand rails
Stainless steel upholstery staples
Steel-reinforced molds
Stern eyes
Transferable hull-and-structural components limited lifetime warranty
Wiring harness with color-coded and labeled wires—meets ABYC standards
Vinyl—34 oz. premium grade with UV protection and mildew resistors, UV-protected threads

Wakeboarding and Water Ski Performance

Adjustable, oversized convex mirror with bracket, removable
USA Water Ski-endorsed
Speedometer
Wear-Guard anodized aluminum ski pylon, patented

Optional Equipment

Propulsion and Systems

MasterCraft Power Vortec MCX 5.7L multi-port EFI 350-cubic-inch GM V-8 engine—350 hp
MasterCraft Power Vortec Cadillac LQ9 HO 6.0L multi-port EFI V-8 engine—385 hp
MasterCraft Power Vortec L18 HO 8.1L EFI 496-inch GM V-8 engine—425 hp
Closed cooling system (not available with shower, standard with Cadillac LQ9 engine)
European package

210

Canvas and Carpet

- Bimini top (dealer-installed)
- Bow tonneau cover (dealer-installed)
- Cockpit mooring cover (dealer-installed)
- Sun top (dealer-installed)
- Towable boat cover
- Towable boat cover for tower

Comfort and Convenience

- Bow filler cushion
- Clarion 6-disc CD changer
- Clarion transom-mounted stereo digital read-out remote control
- Cockpit table, stowable, with drink holders
- Depth finder
- Fiberglass swim platform—removable, available in all gel colors
- Heater
- Pressurized hot/cold shower (not available with closed cooling system)

Construction

- Extended warranty
- Custom gel coat
- Metal flake gel coat
- Rearrangement of upholstery colors

Wakeboarding and Water Ski Performance

- Perfect Pass Cruise
- Perfect Pass Wakeboard Edition
- Binding Blaster soap pump
- KGB system, including saddle tanks
- Teak transom saver (not available with fiberglass swim platform)
- ZeroFlex Flyer tower with board racks (two sides)

- Slalom rack (one side)
- Clarion tower speakers (150 watts each) with amp
- Two sets of tower speakers
- Two sets of speakers with lights (kit includes two lights/four speakers)
- Tower light bar with four lights (either two forward and two aft, or four aft)

Trailers

- Canadian-approved trailer
- Galvanized single-axle trailer with disc brakes with swing-away tongue
- Galvanized tandem-axle trailer with disc brakes with swing-away tongue

- Single axle trailer with disc brakes with swing-away tongue
- Tandem axle trailer with disc brakes with swing-away tongue
- Spare trailer tire and wheel assembly (available aluminum or galvanized)

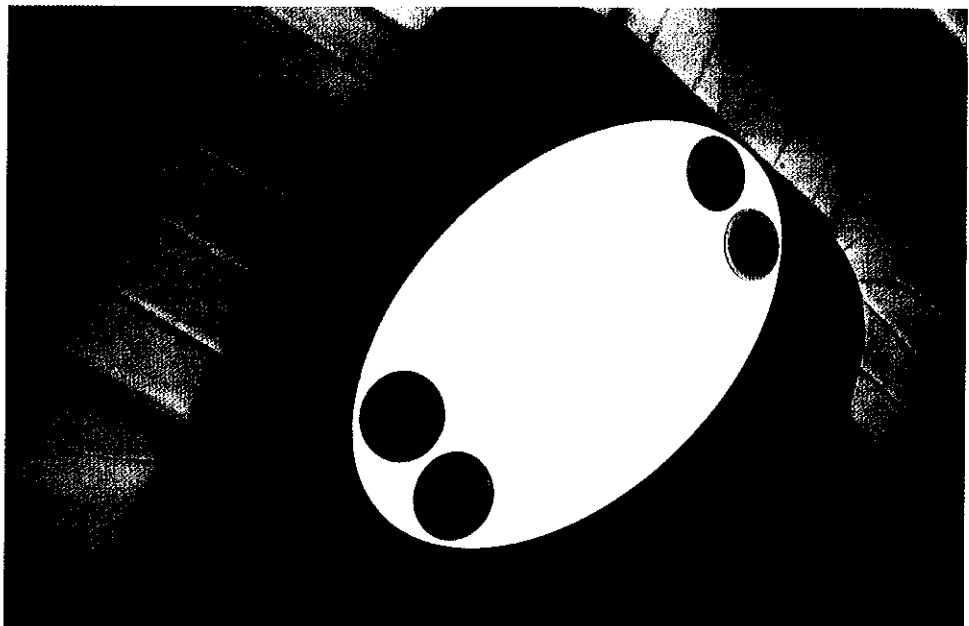

230



LAYOUT

- A STERN LIGHT RECEPTACLE
- B BLOWER EXHAUST
- C SWIM PLATFORM
- D FUEL TANK FILLER
- E STORAGE UNDER SUN PAD
- F BATTERY (BEHIND SEAT)
- G THROTTLE/SHIFT CONTROL
- H INSTRUMENT PANEL
- I BOW LIGHT
- J GLOVE BOX
- K FIRE EXTINGUISHER (BEHIND SEAT)
- L SKI LOCKER
- M ENGINE COMPARTMENT

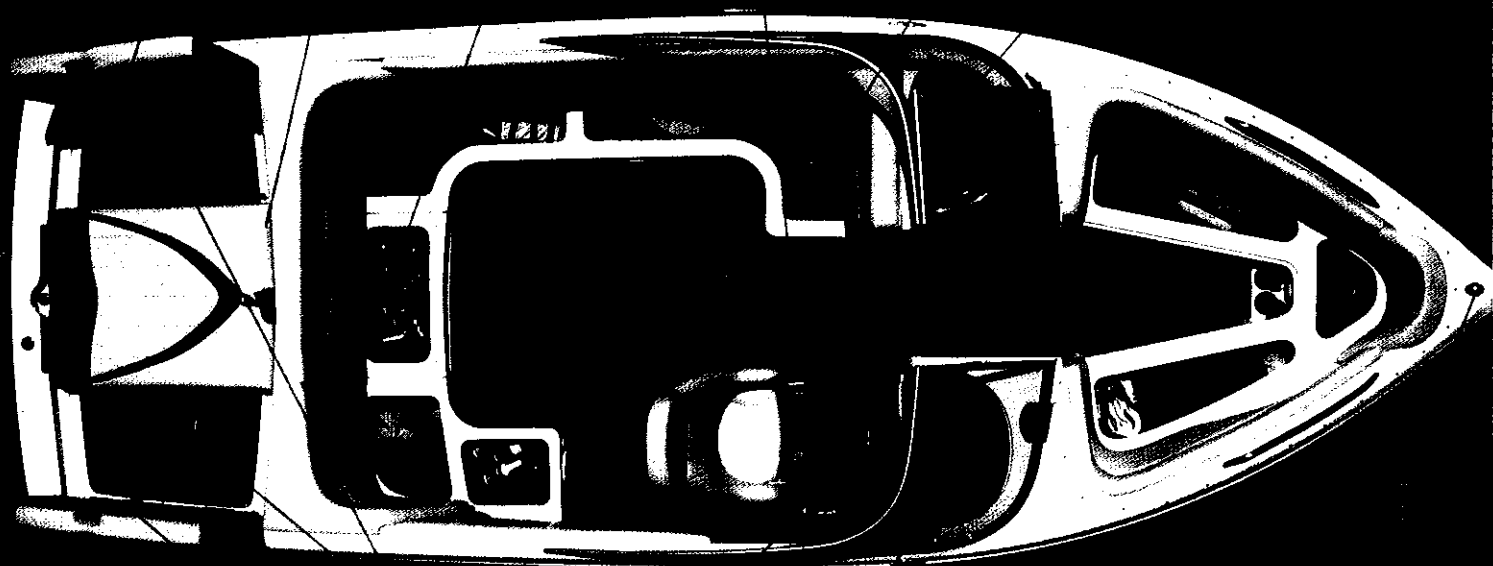

The MasterCraft Movement

The

230



Standard Equipment

Propulsion and Systems

MasterCraft Power Vortec Predator 5.7L EFI
TBI 350-cubic-inch GM V-8 engine—310 hp
1.56:1 gear ratio transmission
4-blade 14-inch propeller, right-hand rotation
3-year limited engine warranty
Competition throttle control
Dual exhaust system
Dual fuel filtration system
Engine temperature gauge
EZ Change oil kit
Fuel gauge
High-pressure in-tank fuel pump
Low-battery voltage alarm
Oil pressure gauge
Silent Master muffler/exhaust system
Tachometer with hourmeter
Voltmeter

Comfort and Convenience

Two (2) 12-volt DC power outlets
Center drain with threaded drain plug
Clarion AM/FM CD stereo system with four marine speakers, with remote control on instrument panel
Companionway walk-thru wind enclosure, canvas
Custom steering wheel, ergonomically designed
Custom dash
Depth finder
Drink holders
MasterView driver's seat
Driver's side armrest
Driver's side storage tray
Glove box
Observer's seat—aft facing
Storage under bow seating
Storage under sun pad, illuminated
Sun pad, three-piece
Teak swim platform, removable
Tilt steering wheel
Transom drain plug
Transom hand rail with integral tow loop

Construction

All hand-laid fiberglass construction
All stainless steel and non-corrosive hardware
Aluminum floorboards
AnchorLok reinforcing plates, steel, aluminum, or HDPE, on all key parts
Bow eye, stainless steel
CelMaster reticulated dry-foam seat construction
Circuit breakers
Cross-linked polyethylene fuel cell

Curved tempered safety glass windshield
Dripless shaft seal system
Exclusive splined propeller and propeller shaft with lock nut
Gel coat tolerances to +/- .005"
Heavy-duty 40 oz. marine carpet with 5-year limited warranty
Insulated and vented engine compartment
Integrated gel coat striping
M.O.D.S. MasterCraft Oscillation Dampening System for noise and vibration reduction
Magnesium bronze rudder box with o-rings and grease fittings

Wiring harness with color-coded and labeled wires—meets ABYC standards
Vinyl—34 oz. premium grade with UV protection and mildew resistors, UV-protected threads

Safety

Bilge blower
Engine warning light and alarm
Fire extinguisher
Flotation exceeding USCG requirements
Fully automatic bilge pump system with manual override
Horn

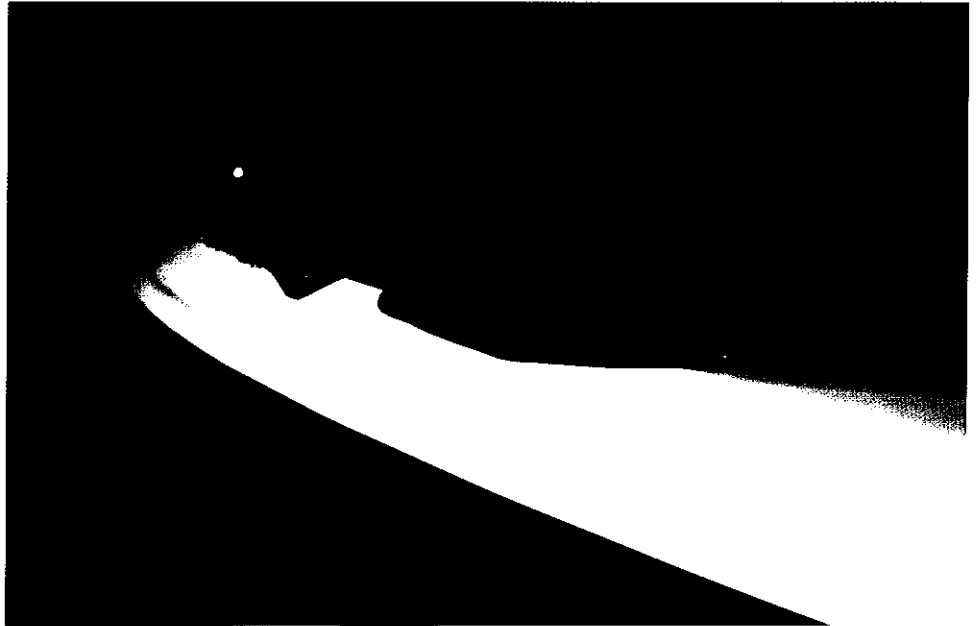

Magnesium bronze rudder with 1-1/8" stainless steel shaft
Magnesium bronze strut with 8-bolt mounting and dual bearings
MasterCraft custom steering connection with grease fittings
MasterCraft electromechanical custom gauges
Monocoque integrated stringer system
No-spill gas fill
On-water quality assurance testing of every boat
Precision Touch II rack-and-pinion steering system
Pull-up cleats
Pop-up cleats
Rigid PVC rub rail with vinyl insert
Stainless steel bow hand rails
Stainless steel upholstery staples
Steel-reinforced molds
Stern eyes
Transferable hull-and-structural components limited lifetime warranty

Inland lighting
NMMA-certified for safety
Safety engine stop switch

Wakeboarding and Water Ski Performance

Adjustable, oversized convex mirror with bracket, removable
USA Water Ski-endorsed
Speedometer
Wear-Guard anodized aluminum ski pylon, patented

Optional Equipment

Propulsion and Systems

MasterCraft Power Vortec MCX 5.7L multi-port EFI 350-cubic-inch GM V-8 engine—350 hp
MasterCraft Power Vortec Cadillac LQ9 HO 6.0L multi-port EFI V-8 engine—385 hp
MasterCraft Power Vortec L18 HO 8.1L EFI 496-inch GM V-8 engine—425 hp

230



Closed cooling system (not available with shower, standard with Cadillac LQ9 engine)
European package

Canvas and Carpet

Bimini top (dealer-installed)
Bow tonneau cover (dealer-installed)
Cockpit mooring cover (dealer-installed)
Sun top (dealer-installed)
Towable boat cover
Towable boat cover for tower

Comfort and Convenience

Bow filler cushion
Clarion 6-disc CD changer
Amplifier and subwoofer
Clarion transom-mounted stereo digital read-out remote control
Cockpit table, stowable with drink holders
Fiberglass swim platform—removable, available in all gel colors
Heater
Pressurized hot/cold shower (not available with closed cooling system)

Construction

Extended warranty
Custom gel coat
Metal flake gel coat
Rearrangement of upholstery colors

Wakeboarding and Water Ski Performance

Perfect Pass Cruise
Perfect Pass Wakeboard Edition

Binding Blaster soap pump
KGB system, including saddle tanks
Teak transom saver (not available with fiberglass swim platform)
ZeroFlex Flyer tower with board racks (two sides)
Slalom rack (one side)
Clarion tower speakers (150 watts each) with amp
Two sets of tower speakers
Two sets of speakers with lights (kit includes two lights/four speakers)
Tower light bar with four lights (either two forward and two aft, or four aft)

Trailers

Canadian-approved trailer
Galvanized tandem-axle trailer with disc brakes with swing-away tongue
Tandem axle trailer with disc brakes with swing-away tongue
Spare trailer tire and wheel assembly (available aluminum or galvanized)



280

Length of Boat: 28'3"

Width Amidship: 9'6"

Boat Weight: 5,200 lbs. (approx.)

Fuel Capacity: 83 gallons

Depth at Transom: 34"

Depth Amidship: 37"

Draft: 29"

Capacity: 15 people/2296 lbs.

As this publication went to press, the following was the best information available for the 280 VLD. Due to on-going efforts to make this the finest boat possible, some changes may have been effected in standard and optional equipment as well as locations.



LAYOUT

- A BLOWER EXHAUST
- B SWIM PLATFORM
- C FUEL TANK FILLERS
- D BATTERIES
- E THROTTLE/SHIFT CONTROL
- F INSTRUMENT PANEL
- G BOW LIGHTS
- H FIRE EXTINGUISHER (UNDER DASH)
- I SKI LOCKER
- J ENGINE COMPARTMENT
- K SINK
- L HEAD

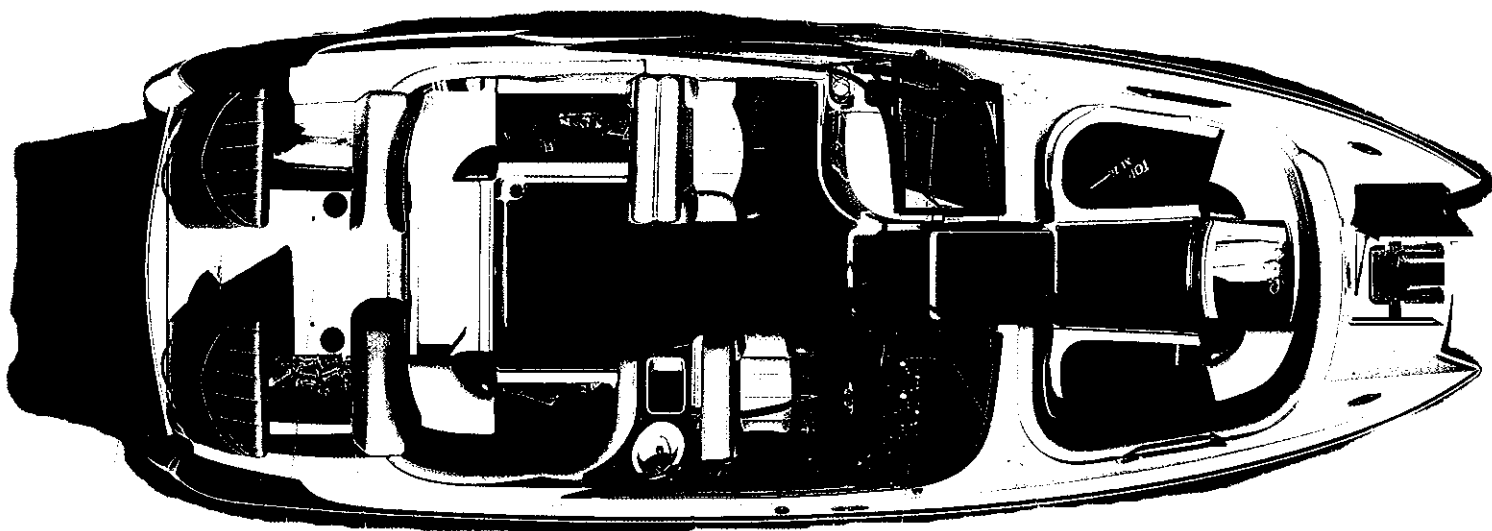

The MasterCraft Movement

The M A R I S T A R 280 VLD



Standard Equipment

Propulsion and Systems

MasterCraft Power Vortec Cadillac LQ9 HO 6.0L multi-port EFI V-8 engine—385 horsepower (equipped with closed cooling system)
1.56:1 gear ratio transmission
3-year limited engine warranty
Competition throttle control
Dual exhaust system
Dual fuel filtration system
Engine temperature gauge
EZ Change oil kit
Fuel gauge
High-pressure in-tank fuel pump
Low-battery voltage alarm
Oil pressure gauge
SilentMaster muffler/exhaust system
Tachometer with hourmeter
Voltmeter

Comfort and Convenience

Three (3) 12-volt DC power outlets
Anchor locker with four-step ladder
Clarion AM/FM CD stereo system with six marine speakers, with remote, amp and subwoofer
Companionway walk-thru bi-fold door
Custom steering wheel, ergonomically designed
Custom wood grain dash
Depth finder
Driver's side armrest
Dual battery switch with isolater
Enclosed head with porta-potty (includes overhead light and port light)
Entertainment Center (sink with pressurized water, small forward tank, ice bucket, Stainless steel grab rail)
MasterView driver's seat
Observer's seat converts to aft-facing lounge seat
Seventeen (17) drink holders
Storage under bow seating
Storage under sun pad
Sun pad, two-piece
Fiberglass swim platform with teak inlay, non-removable
Tilt steering wheel
Transom drain plug
Trash receptacle
Two (2) transom handrails

Construction

All hand-laid fiberglass construction
All stainless steel and non-corrosive hardware

AnchorLok reinforcing plates, steel, aluminum, or HDPE, on all key parts
Bow eye, stainless steel
CelMaster reticulated dry-foam seat construction
Circuit breakers
Composite integrated stringer system
Cross-linked polyethylene fuel cell
Curved tempered safety glass windshield
Dripless shaft seal system
Dual no-spill gas fill
Exclusive splined propeller and propeller shaft with lock nut

Stainless steel bow hand rails
Stainless steel propeller
Stainless steel upholstery staples
Steel-reinforced molds
Stainless steel stern eyes
Transferable hull-and-structural components limited lifetime warranty
Trim tabs, electric with electronic read-out
Wiring harness with color-coded and labeled wires—meets ABYC standards
Vinyl—34 oz. premium grade with UV protection and mildew resisters, UV-protected threads

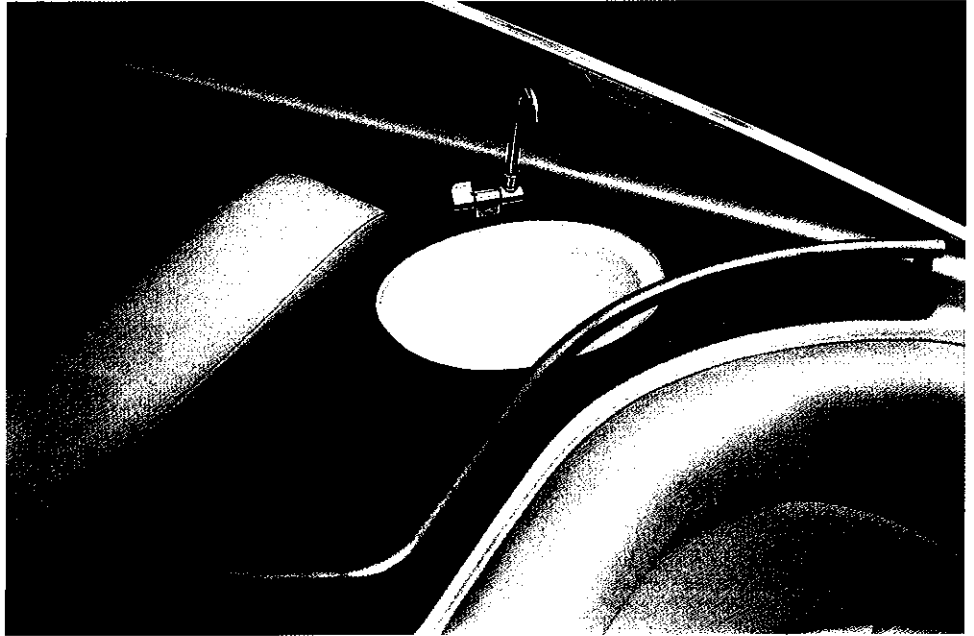

Gel coat tolerances to +/- .005"
Heavy-duty 40 oz. Marine carpet with five-year limited warranty
Insulated and vented engine compartment
Integrated gel coat striping
M.O.D.S. MasterCraft Oscillation Dampening System for noise and vibration reduction
Magnesium bronze rudder box with o-rings and grease fittings
Magnesium bronze rudder with 1-1/8" stainless steel shaft
Magnesium bronze strut with 8-bolt mounting and dual bearings
MasterCraft custom steering connection with grease fittings
MasterCraft electromechanical custom gauges
On-water quality assurance testing of every boat
Precision Touch II rack-and-pinion steering system
Rigid PVC rub rail with stainless steel insert
Six (6) pull-up cleats

Safety

Bilge blower
Engine warning light and alarm
Fire extinguisher
Fully automatic bilge pump system with manual override
Horn
Inland lighting
NMMA-certified for safety
Safety engine stop switch

Wakeboarding and Water Ski Performance

Adjustable, oversized convex mirror with bracket, removable
Speedometer
ZeroFlex Flyer tower

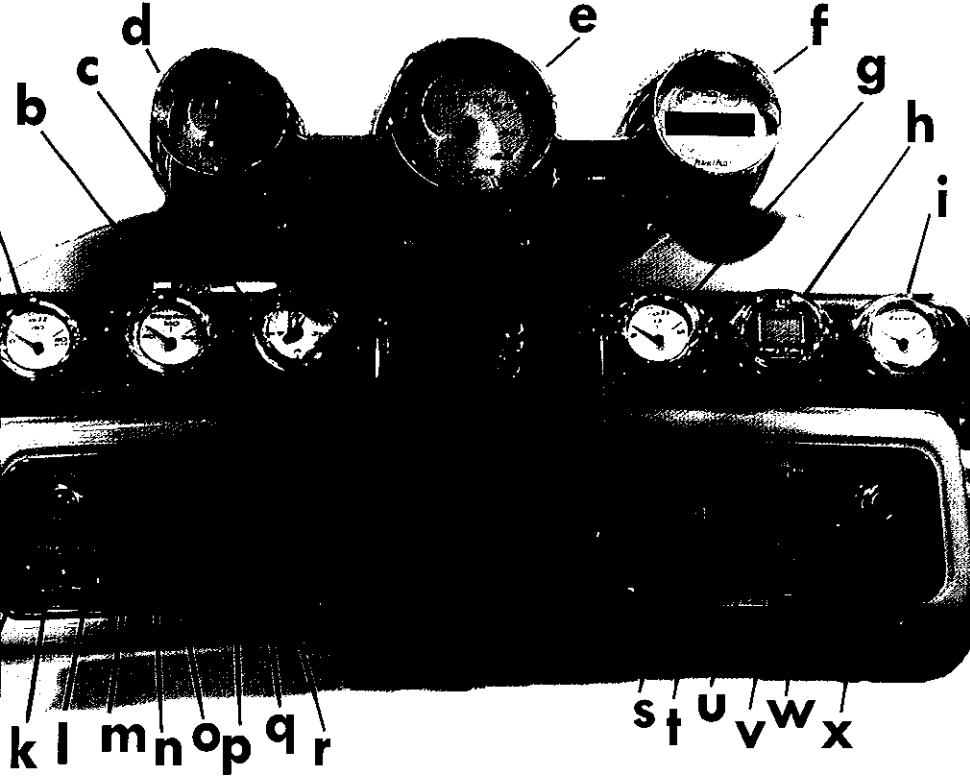

280

- A OIL GAUGE
- B TEMPERATURE GAUGE
- C CLOCK
- D TACHOMETER
- E SPEEDOMETER
- F PERFECT PASS GAUGE
- G VOLTMETER
- H DEPTH FINDER
- I FUEL GAUGE
- J HORN
- K CLOCK ADJUSTMENT SWITCH
- L SPEEDOMETER ADJUSTMENT SWITCH
- M COURTESY LIGHTS SWITCH
- N SHOWER SWITCH
- O HEATER SWITCH
- P ACCESSORY 1
- Q ACCESSORY 2
- R ACCESSORY 3
- S TOWER LIGHT SWITCH
- T TOWER LIGHT SWITCH
- U BLOWER SWITCH
- V BILGE SWITCH
- W NAV/ANCHOR LIGHTS SWITCH
- X IGNITION SWITCH

Optional Equipment

Propulsion and Systems

- MasterCraft Power Vortec L18 HO 8.1L EFI 496-cubic-inch GM V-8 engine—450 horsepower
- Closed cooling system
- European package
- Battery, installed
- Bow thruster

Canvas and Carpet

- Bimini top (dealer-installed)
- Bow tonneau cover (dealer-installed)
- Cockpit mooring cover (dealer-installed)
- Towable boat cover for tower

Comfort and Convenience

- Bow filler cushion
- Center sun deck filler cushion
- Cockpit rear filler cushion
- Clarion transom-mounted stereo digital read-out remote control
- Cockpit table, stowable with drink holders
- Heater
- Pressurized hot/cold shower (not available with closed cooling system)
- Swim platform with rubber inlay, non-removable

Construction

- Extended warranty
- Custom gel coat

- Metal flake gel coat
- Pure ventilation system with gauges
- Rearrangement of upholstery colors
- Teak decking system on engine hatch

Wakeboarding and Water Ski Performance

- Ballast system, including saddle tanks with sending units
- Binding Blaster soap pump
- Board racks (two sides)
- Clarion tower, speakers
- Perfect Pass Pro Wakeboard
- Two sets of tower speakers

- Two sets of speakers with lights (kit includes two lights/four speakers)
- Tower with board racks
- Tower light bar with four lights (either two forward and two aft, or four aft)
- Tower mirror attachment

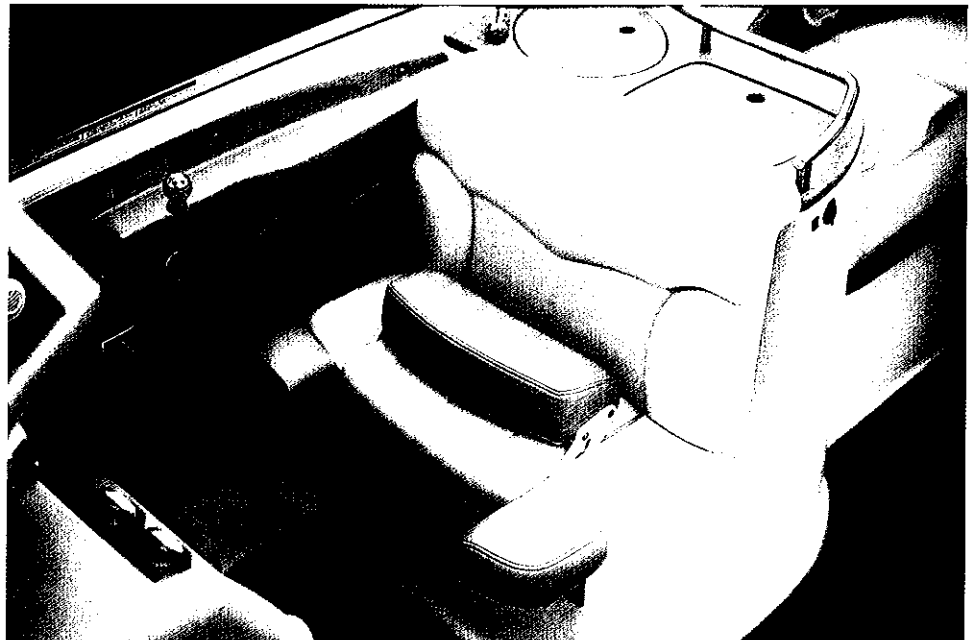



Length of Boat: 19'8"
Length of Boat with Platform: 21'6"
Width Amidship: 91"
Overall Length w/Trailer: 22'10"
W/swing-away tongue folded: 21'1"
Overall Width w/Trailer:
99" (single-axle)
100" (tandem-axle)
Boat Weight: 2,800 lbs. (approx.)
Single Axle Trailer Weight: 860 lbs.
Tandem Axle Trailer Weight: 1,040 lbs.
Fuel Capacity: 28 gallons
Depth at Transom: 20"
Depth Amidship: 23-1/2"
Draft: 22"
Tow Bar Height to Waterline: 29"
Capacity: 10 people or 1,340 lbs.

LAYOUT

- A FUEL TANK FILLER
- B BLOWER EXHAUST
- C SWIM PLATFORM
- D STERN LIGHT RECEPTACLE
- E STORAGE UNDER SUN PAD
- F ENGINE COMPARTMENT
- G THROTTLE SHIFT CONTROL
- H INSTRUMENT PANEL
- I BOW LIGHT
- J GLOVE BOX
- K BATTERY (BEHIND SEAT)
- L FIRE EXTINGUISHER (BEHIND SEAT)
- M DRAIN PLUG

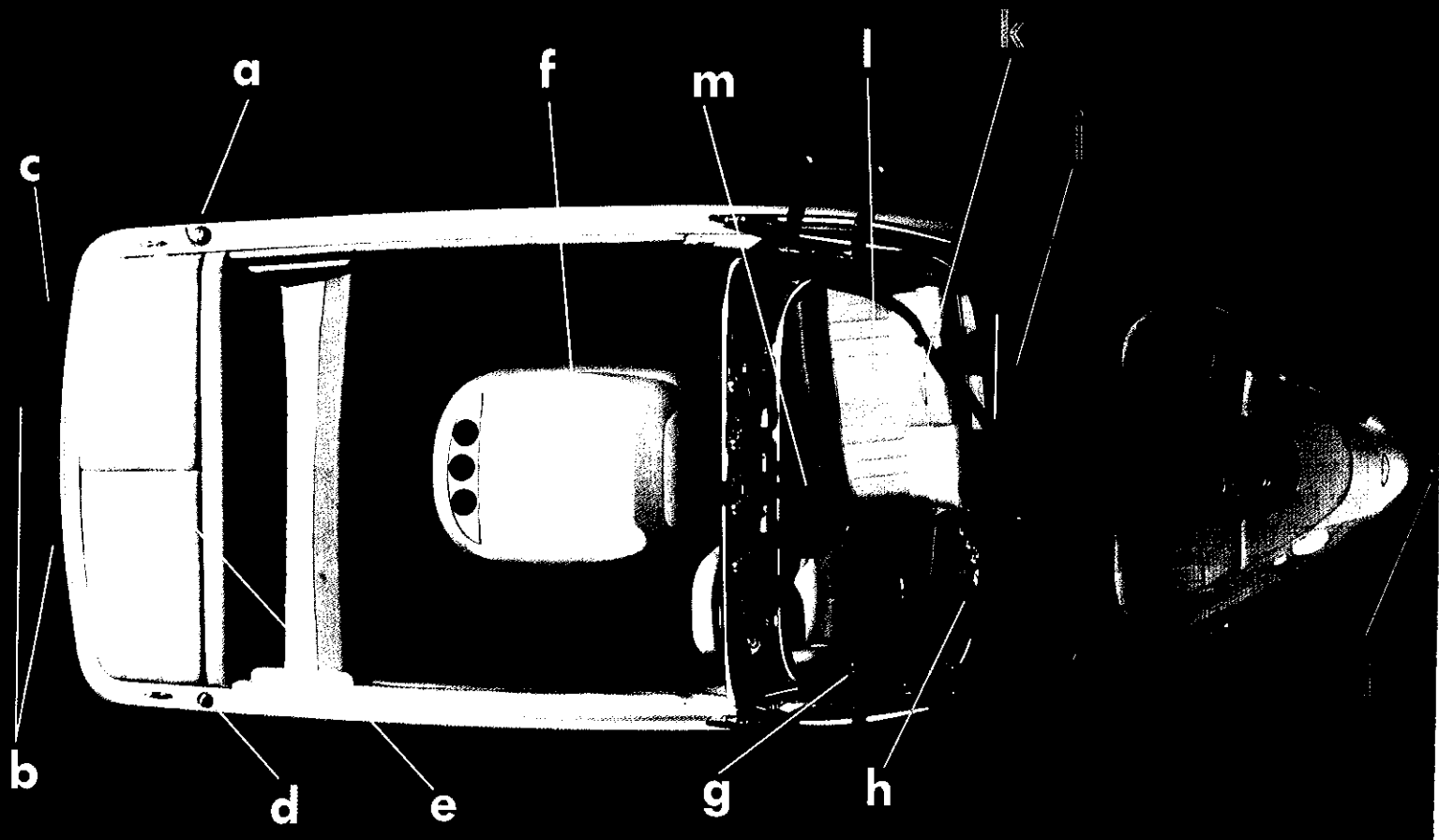



The X - 7



Standard Equipment

X-7 Package, which includes: tower, stereo with digital read-out remote, amp and subwoofer, ballast system, monograms, decal kit, transom saver, walk-thru seat

Propulsion and Systems

MasterCraft Power Vortec Predator 5.7L EFI
TBI 350-cubic-inch GM V-8 engine—310 hp
1:1 gear ratio transmission
4-blade 13-inch propeller
3-year limited engine warranty
Competition throttle control
Dual exhaust system
Dual fuel filtration system
Engine temperature gauge
EZ Change oil kit
Fuel gauge
High-pressure in-tank fuel pump
Low-battery voltage alarm
Oil pressure gauge
Silent Master muffler/exhaust system
Tachometer with hourmeter
Voltmeter

Comfort and Convenience

Two (2) 12-volt DC power outlets
Built-in cooler with drain and dual access
Center drain with threaded drain plug
Chronograph clock
Companionway walk-thru wind enclosure, canvas
Custom polished aluminum steering wheel, ergonomically designed
Eight (8) drink holders
MasterView driver's seat
Gas-filled lifts for motor box cover
Glove box, water-resistant with space for stereo and integral shelf
Observer's seat—aft facing (fits 3 people)
Illuminated lockable storage behind observer's seat
Recessed floor area with drain—driver's area
Storage under bow seating
Storage under sun pad, illuminated
Sun pad—hinged, full access, split deck
Teak swim platform, removable
Tilt steering wheel
Two-piece fully insulated motor box

Construction

All hand-laid fiberglass construction
All stainless steel and non-corrosive hardware
Aluminum floorboards
AnchorLok reinforcing plates, steel, aluminum, or HDPE, on all key parts
Bow eye, stainless steel
CelMaster reticulated dry-foam seat construction
Circuit breakers

Cross-linked polyethylene fuel cell
Curved tempered safety glass windshield
Drip-molded decals
Exclusive splined propeller and propeller shaft with lock nut
Gel coat tolerances to +/- .005"
Heavy-duty 40 oz. marine carpet with 5-year limited warranty
Integrated gel coat striping
M.O.D.S. MasterCraft Oscillation Dampening System for noise and vibration reduction
Magnesium bronze rudder box with o-rings and grease fittings
Magnesium bronze rudder with 1-1/8" stainless steel shaft
Magnesium bronze strut with 8-bolt mounting and dual bearings
MasterCraft custom steering connection with grease fittings
MasterCraft electromechanical custom gauges
Monocoque integrated stringer system
No-spill gas fill
On-water quality assurance testing of every boat

Safety

Automatic/manual bilge pump system
Bilge blower
Engine warning light and alarm
Fire extinguisher
Flotation exceeding USCG requirements
Horn
Inland lighting
NMMA-certified for safety
Safety engine stop switch

Wakeboarding and Water Ski Performance

Adjustable, oversized convex mirror with bracket, removable
USA Water Ski-approved
Parabolic tracking fins
Side panel ski storage
Swing-open center seat for walk-thru
Two (2) tournament speedometers
Transom ski tow eye
Wear-Guard anodized aluminum ski pylon, patented



Precision Touch II rack-and-pinion steering system
Rigid PVC rub rail with vinyl insert
Stainless steel interior bow hand rails
Stainless steel upholstery staples
Steel-reinforced molds
Stern eyes
Transferable hull-and-structural components limited lifetime warranty
Wiring harness with color-coded and labeled wires—meets ABYC standards
Vinyl—34 oz. premium grade with UV protection and mildew resistors, UV-protected threads

Optional Equipment

Propulsion and Systems

MasterCraft Power Vortec MCX 5.7L multi-port EFI 350-cubic-inch GM V-8 engine—350 hp
MasterCraft Power Vortec Cadillac LQ9 HO 6.0L multi-port EFI V-8 engine—385 hp
MasterCraft Power Vortec L18 HO 8.1L EFI 496-inch GM V-8 engine—425 hp
1.5:1 gear ratio patented PowerSlot package (includes 4-blade 14x18 propeller)

X-7

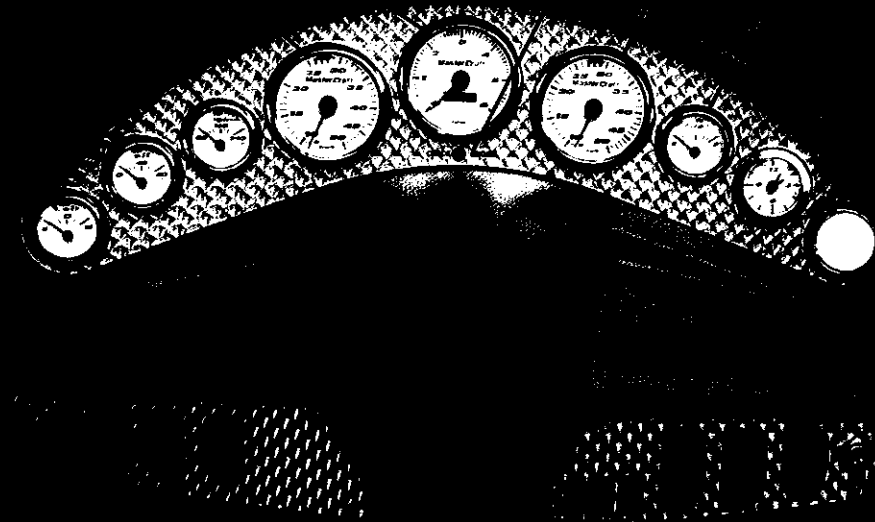

Closed cooling system (not available with shower, standard with Cadillac LQ9 engine)
European package
Hood scoop (available with medium motor box)

Canvas and Carpet

Bimini top (dealer-installed)
Bow tonneau cover (dealer-installed)
Cockpit mooring cover (dealer-installed)
Sun top (dealer-installed)
Towable boat cover for tower

Comfort and Convenience

Clarion 6-disc CD changer
Clarion transom-mounted stereo digital read-out remote control
Depth finder
Fiberglass swim platform—removable, available in all gel colors
Heater
Pressurized hot/cold shower (not available with closed cooling system)
Pull-up cleats for bow (stainless, flush-mounted)
Pull-up cleats for stern (stainless, flush-mounted)

Construction

Extended warranty
Custom gel coat
Metal flake gel coat
Rearrangement of upholstery colors

Wakeboarding and Water Ski Performance

Perfect Pass Digital Pro

Perfect Pass Cruise
Perfect Pass Wakeboard Edition
Binding Blaster soap pump
Tournament KPH speedometers (two—no-charge option)
Water temperature gauge (in place of clock)
Slalom rack (one side)
Clarion tower speakers (150 watts each) with amp
Two sets of tower speakers
Two sets of speakers with lights (kit includes two lights/four speakers)
Tower light bar with four lights (either two forward and two aft, or four aft)

Trailers

Canadian-approved trailer

Galvanized single-axle trailer with disc brakes with swing-away tongue
Galvanized tandem-axle trailer with disc brakes with swing-away tongue
Single axle trailer with disc brakes with swing-away tongue
Tandem axle trailer with disc brakes with swing-away tongue

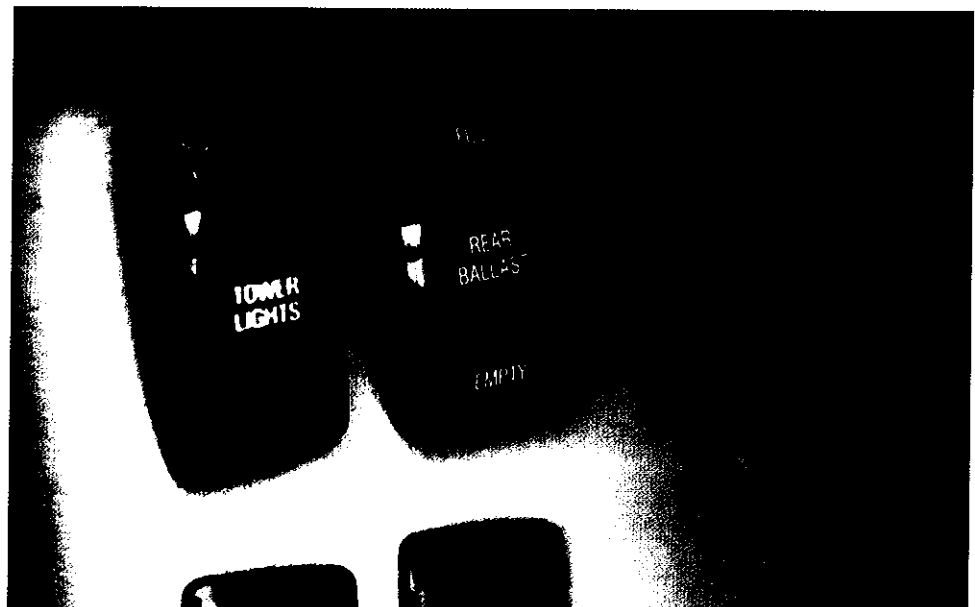

22' 9-1/2" 20' 11-1/2" 96" 23' 1" 21' 4" 100" 2,850 lbs. (approx.) 900 lbs. 1050 lbs. 35 gallons 23" 25-1/2" 22" 29" 12 people or 1,705 lbs.

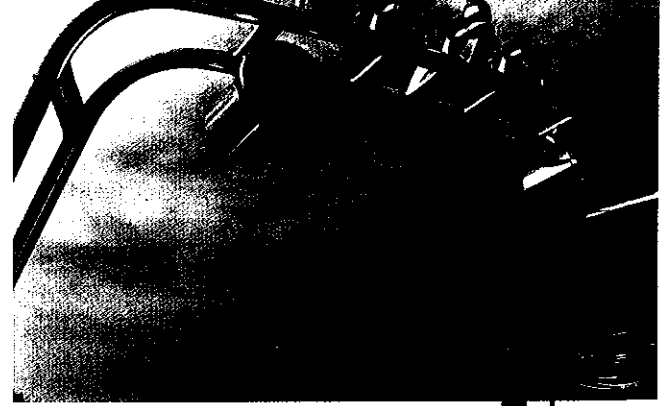

LAYOUT

- A FUEL TANK FILLER
- B BLOWER EXHAUST
- C SWIM PLATFORM
- D STERN LIGHT RECEPTACLE
- E STORAGE UNDER SUN PAD
- F ENGINE COMPARTMENT
- G THROTTLE SHIFT CONTROL
- H INSTRUMENT PANEL
- I BOW LIGHT
- J GLOVE BOX
- K BATTERY (BEHIND SEAT)
- L FIRE EXTINGUISHER (BEHIND SEAT)
- M DRAIN PLUG

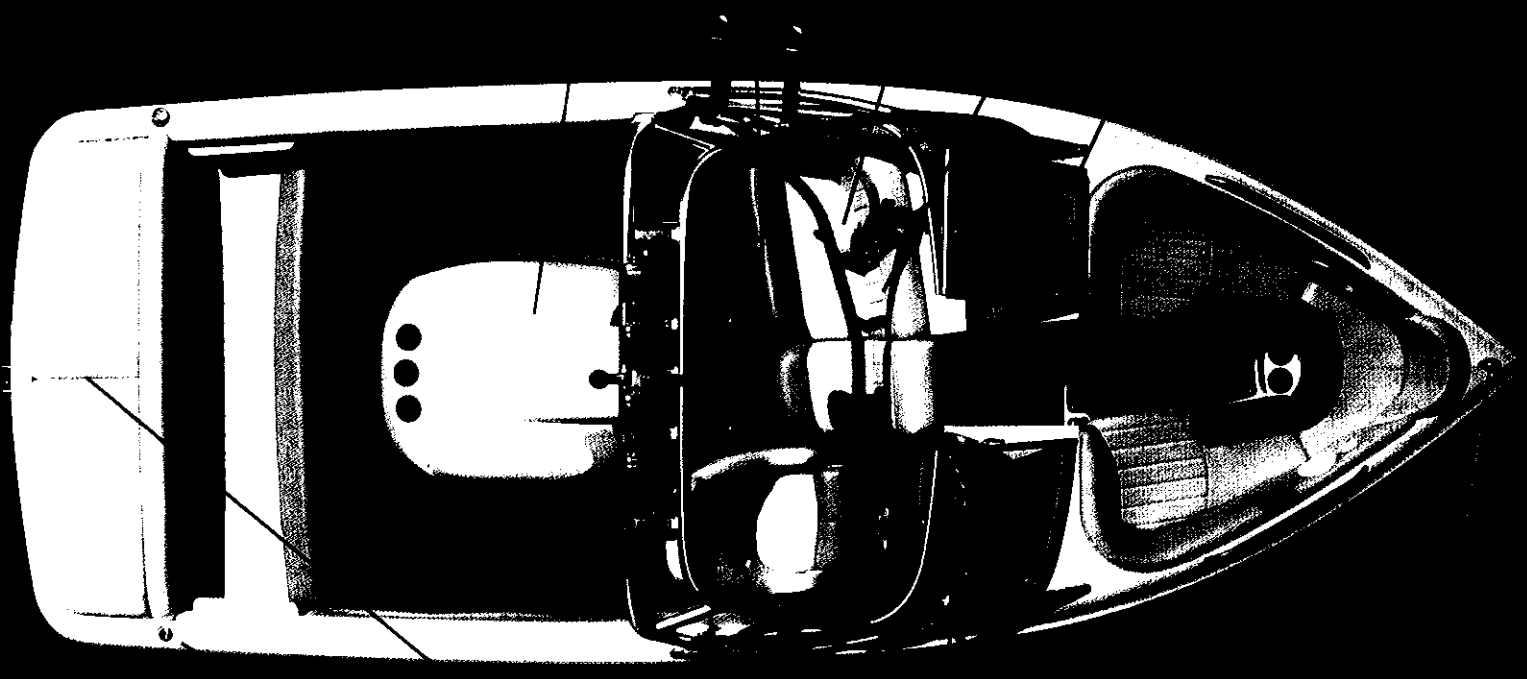

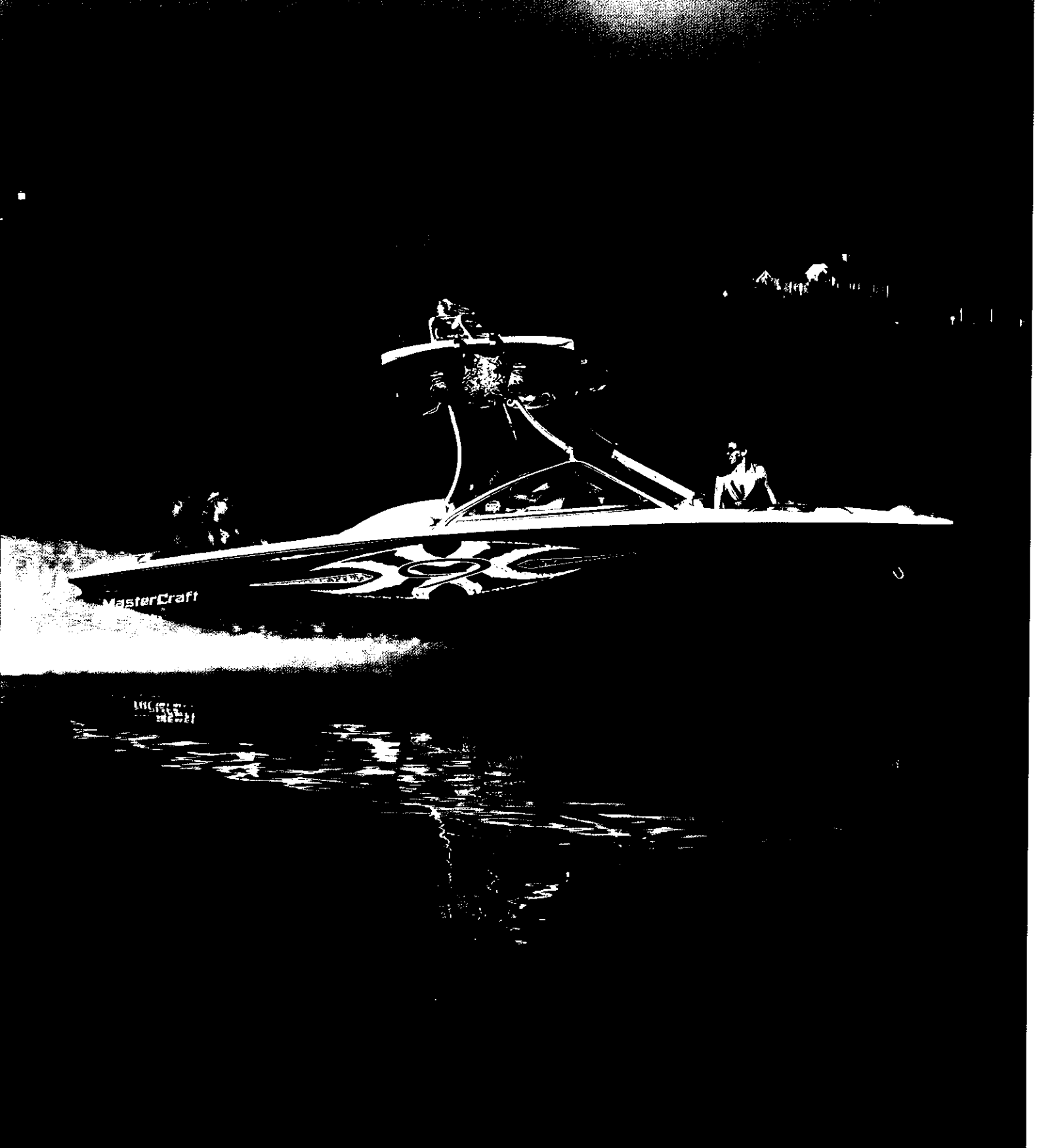

The X - 9

Standard Equipment

X-9 Package, which includes: tower, stereo with digital read-out remote, amplifier and subwoofer, ballast system, monograms, decal kit, transom saver and walk-thru seat.

Propulsion and Systems

MasterCraft Power Vortec Predator 5.7L EFI TBI 350-cubic-inch GM V-8 engine—310 hp
1:1 gear ratio transmission
4-blade 13-inch propeller
3-year limited engine warranty
Competition throttle control
Dual exhaust system
Dual fuel filtration system
Engine temperature gauge
EZ Change oil kit
Fuel gauge
High-pressure in-tank fuel pump
Low-battery voltage alarm
Oil pressure gauge
Silent Master muffler/exhaust system
Tachometer with hourmeter
Voltmeter

Comfort and Convenience

Two (2) 12-volt DC power outlets
Built-in cooler with drain and ski storage locker
Center drain with threaded drain plug
Chronograph clock
Companionway walk-thru wind enclosure, canvas
Custom polished aluminum steering wheel, ergonomically designed
Eight (8) drink holders
MasterView driver's seat
Gas-filled lifts for motor box cover
Glove box, water-resistant with space for stereo
Observer's seat—aft facing
Illuminated lockable storage behind observer's seat
Rear seat converts to three-person sun pad
Recessed floor area with drain—driver's area
Removable lower rear seat cushion
Storage under sun pad, illuminated
Sun pad—full access, split deck
Teak swim platform, removable
Tilt steering wheel
Two-piece fully insulated motor box
Transom hand rail with integral tow loop

Construction

All hand-laid fiberglass construction
All stainless steel and non-corrosive hardware
Aluminum floorboards
AnchorLok reinforcing plates, steel, aluminum, or HDPE, on all key parts
Bow eye, stainless steel
CelMaster reticulated dry-foam seat construction
Circuit breakers

Cross-linked polyethylene fuel cell
Curved tempered safety glass windshield
Drip-molded decals
Exclusive splined propeller and propeller shaft with lock nut
Gel coat tolerances to +/- .005"
Heavy-duty 40 oz. marine carpet with 5-year limited warranty
Integrated gel coat striping
M.O.D.S. MasterCraft Oscillation Dampening System for noise and vibration reduction
Magnesium bronze rudder box with o-rings and grease fittings
Magnesium bronze rudder with 1-1/8" stainless steel shaft
Magnesium bronze strut with 8-bolt mounting and dual bearings
MasterCraft custom steering connection with grease fittings
MasterCraft electromechanical custom gauges

Engine warning light and alarm
Fire extinguisher
Flotation exceeding USCG requirements
Horn
Inland lighting
NMMA-certified for safety
Safety engine stop switch

Wakeboarding and Water Ski Performance

Adjustable, oversized convex mirror with bracket, removable
USA Water Ski-approved
Parabolic tracking fins
Side panel ski storage
Two (2) tournament speedometers
Wear-Guard anodized aluminum ski pylon, patented



Monocoque integrated stringer system
No-spill gas fill
On-water quality assurance testing of every boat
Precision Touch II rack-and-pinion steering system
Rigid PVC rub rail with vinyl insert
Stainless steel bow hand rails
Stainless steel upholstery staples
Stern eyes
Transferable hull-and-structural components limited lifetime warranty
Wiring harness with color-coded and labeled wires—meets ABYC standards
Vinyl—34 oz. premium grade with UV protection and mildew resistors, UV-protected threads

Safety

Automatic/manual bilge pump system
Bilge blower

Optional Equipment

Propulsion and Systems

MasterCraft Power Vortec MCX 5.7L multi-port EFI 350-cubic-inch GM V-8 engine—350 hp
MasterCraft Power Vortec Cadillac LQ9 HO 6.0L multi-port EFI V-8 engine—385 hp
MasterCraft Power Vortec L18 HO 8.1L EFI 496-inch GM V-8 engine—425 hp
1.5:1 gear ratio patented PowerSlot package (includes 4-blade 14x18 propeller)
Closed cooling system (not available with shower, standard with Cadillac LQ9 engine)
European package
Hood scoop (available with medium motor box)

X-9

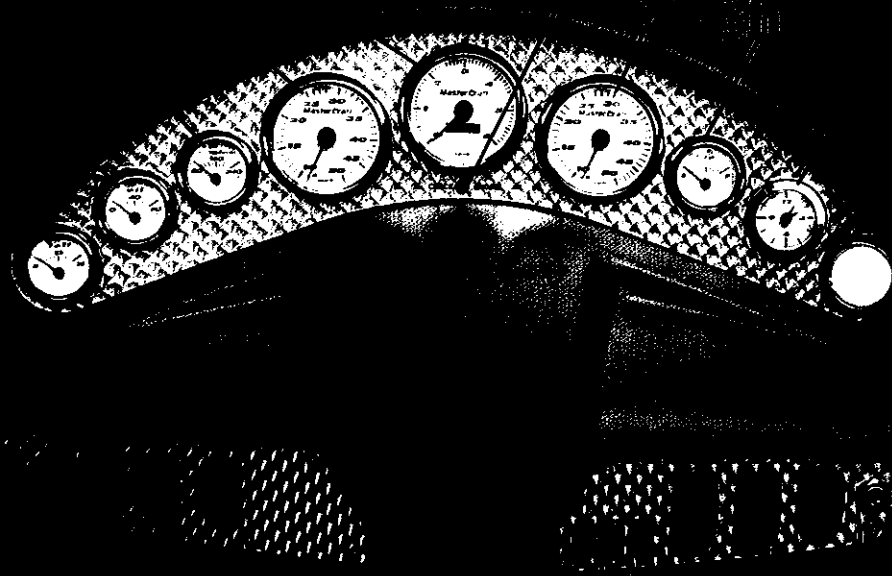

Canvas and Carpet

- Bimini top (dealer-installed)
- Bow tonneau cover (dealer-installed)
- Cockpit mooring cover (dealer-installed)
- Sun top (dealer-installed)
- Towable boat cover for tower

Comfort and Convenience

- Bow filler cushion
- Clarion 6-disc CD changer
- Clarion transom-mounted stereo digital read-out remote control
- Depth finder
- Fiberglass swim platform—removable, available in all gel colors
- Heater
- Pressurized hot/cold shower (not available with closed cooling system)
- Pull-up cleats for bow (stainless, flush-mounted)
- Pull-up cleats for stern (stainless, flush-mounted)

Construction

- Extended warranty
- Custom gel coat
- Metal flake gel coat
- Rearrangement of upholstery colors

Wakeboarding and Water Ski Performance

- Perfect Pass Pro Series
- Perfect Pass Cruise
- Perfect Pass Wakeboard Edition
- Binding Blaster soap pump
- Teak transom saver (not available with fiberglass swim platform)
- Tournament KPH speedometers (two—no-charge option)

- Water temperature gauge (in place of clock)
- Slalom rack (one side)
- Clarion tower speakers (150 watts each) with amp
- Two sets of tower speakers
- Two sets of speakers with lights (kit includes two lights/four speakers)
- Tower light bar with four lights (either two forward and two aft, or four aft)

Trailers

- Canadian-approved trailer
- Galvanized single-axle trailer with disc brakes with swing-away tongue
- Galvanized tandem-axle trailer with disc brakes with swing-away tongue

- Single axle trailer with disc brakes with swing-away tongue
- Tandem axle trailer with disc brakes with swing-away tongue
- Spare trailer tire and wheel assembly (available aluminum or galvanized)

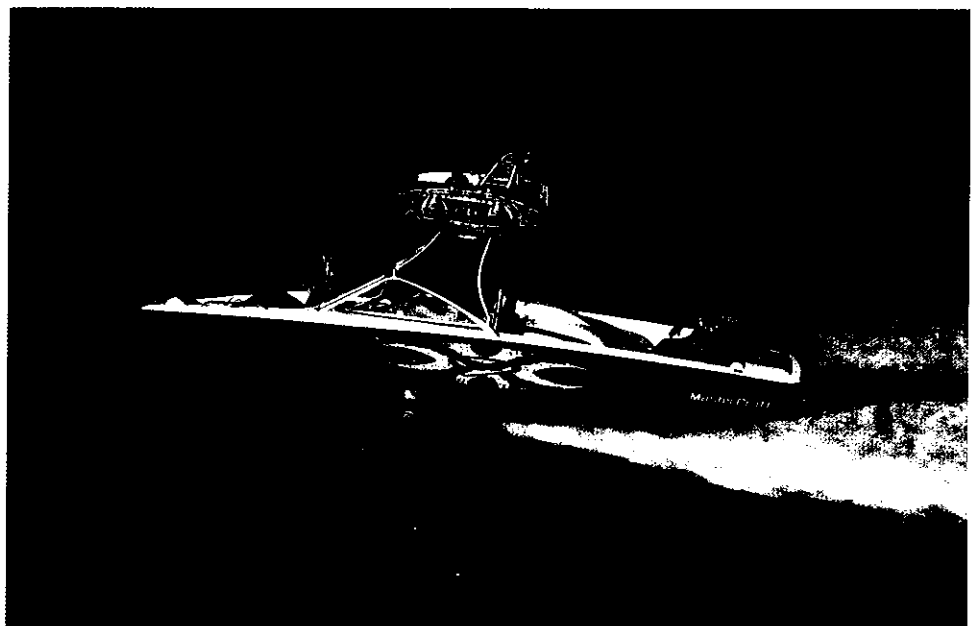

Dimensions

- Length of Boat: 20' 7"**
- Length of Boat with Platform: 22' 6"**
- Width Amidship: 90"**
- Overall Length w/Trailer: 22' 7"**
- W/swing-away tongue folded: 20' 10"**
- Overall Width w/Trailer:**
 - 95" (single-axle)**
 - 96" (tandem-axle)**
- Boat Weight: 3,050 lbs. (approx.)**
- Single Axle Trailer Weight: 860 lbs.**
- Tandem Axle Trailer Weight: 1,040 lbs.**
- Fuel Capacity: 33 gallons**
- Depth at Transom: 23-1/2"**
- Depth Amidship: 25"**
- Draft: 22"**
- Tow Bar Height to Waterline: 29"**
- Capacity: 12 people or 1,720 lbs.**



LAYOUT

- A STERN LIGHT RECEPTACLE
- B BLOWER EXHAUST
- C SWIM PLATFORM
- D FUEL TANK FILLER
- E STORAGE UNDER SUN PAD
- F ENGINE COMPARTMENT
- G THROTTLE SHIFT CONTROL
- H INSTRUMENT PANEL
- I BOW LIGHT
- J GLOVE BOX
- K BATTERY (UNDER SEAT)
- L FIRE EXTINGUISHER (BEHIND SEAT)
- M SKI LOCKER

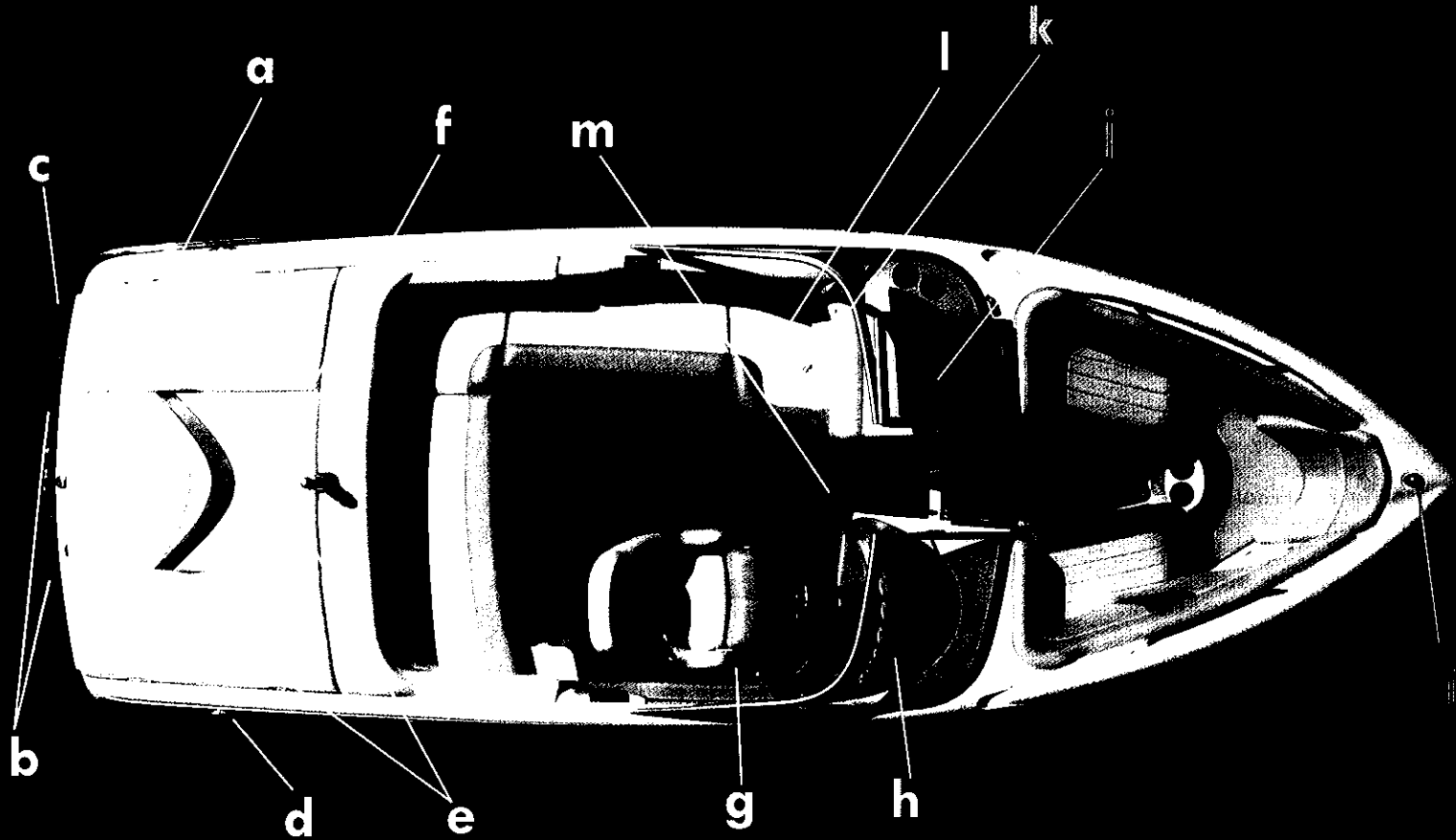

The MasterCraft Movement

The X - 2



Standard Equipment

Propulsion and Systems

MasterCraft Power Vortec Predator 5.7L EFI
TBI 350-cubic-inch GM V-8 engine—310 hp
1.56:1 gear ratio transmission
4-blade 14-inch propeller, right-hand rotation
3-year limited engine warranty
Competition throttle control
Dual exhaust system
Dual fuel filtration system
Engine temperature gauge
EZ Change oil kit
Fuel gauge
High-pressure in-tank fuel pump
Low-battery voltage alarm
Oil pressure gauge
Silent Master muffler/exhaust system
Tachometer with hourmeter
Voltmeter

Comfort and Convenience

Two (2) 12-volt DC power outlets
Center ski storage locker
Center drain with threaded drain plug
Chronograph clock
Companionway walk-thru wind enclosure, canvas
Custom polished aluminum steering wheel, ergonomically designed
Nine (9) drink holders
MasterView driver's seat
Glove box, water-resistant with space for stereo and integral shelf
Observer's seat—aft facing
Storage under bow seating
Storage under sun pad, illuminated
Sun pad, three-piece
Teak swim platform, removable
Tilt steering wheel
Transom drain plug
Transom hand rail with integral tow loop

Construction

All hand-laid fiberglass construction
All stainless steel and non-corrosive hardware
Aluminum floorboards
AnchorLok reinforcing plates, steel, aluminum, or HDPE, on all key parts
Bow eye, stainless steel
CelMaster reticulated dry-foam seat construction
Circuit breakers
Cross-linked polyethylene fuel cell
Curved tempered safety glass windshield
Drip-molded decals
Dripless shaft seal system
Exclusive splined propeller and propeller shaft with lock nut
Gel coat tolerances to +/- .005"
Heavy-duty 40 oz. marine carpet with 5-year limited warranty
Integrated gel coat striping

M.O.D.S. MasterCraft Oscillation Dampening System for noise and vibration reduction
Magnesium bronze rudder box with o-rings and grease fittings
Magnesium bronze rudder with 1-1/8" stainless steel shaft
Magnesium bronze strut with 8-bolt mounting and dual bearings
MasterCraft custom steering connection with grease fittings
MasterCraft electromechanical custom gauges
Monocoque integrated stringer system
No-spill gas fill

Safety engine stop switch

Wakeboarding and Water Ski Performance

Adjustable, oversized convex mirror with bracket, removable
USA Water Ski-endorsed
Parabolic tracking fins
Two (2) tournament speedometers
Wear-Guard anodized aluminum ski pylon, patented



On-water quality assurance testing of every boat
Precision Touch II rack-and-pinion steering system
Rigid PVC rub rail with vinyl insert
Stainless steel bow hand rails
Stainless steel upholstery staples
Steel-reinforced molds
Stern eyes
Transferable hull-and-structural components limited lifetime warranty
Wiring harness with color-coded and labeled wires—meets ABYC standards
Vinyl—34 oz. premium grade with UV protection and mildew resisters, UV-protected threads

Safety

Bilge blower
Engine warning light and alarm
Fire extinguisher
Flotation exceeding USCG requirements
Fully automatic bilge pump system with manual override
Horn
Inland lighting
NMMA-certified for safety

Optional Equipment

Propulsion and Systems

MasterCraft Power Vortec MCX 5.7L multi-port EFI 350-cubic-inch GM V-8 engine—350 hp
Closed cooling system (not available with shower, standard with Cadillac LQ9 engine)
European package

Canvas and Carpet

Bimini top (dealer-installed)
Bow tonneau cover (dealer-installed)
Cockpit mooring cover (dealer-installed)
Sun top (dealer-installed)
Towable boat cover
Towable boat cover for tower

Comfort and Convenience

Bow filler cushion
Clarion AM/FM CD stereo system with four marine speakers, with remote on instrument panel
Clarion AM/FM CD stereo system with subwoofer and high-power amp (500 watts) with remote on instrument panel
Clarion 6-disc CD changer

X-2

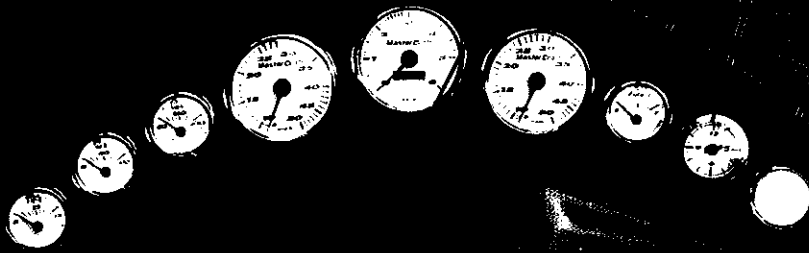

- Clarion transom-mounted stereo remote control
- Depth finder
- Fiberglass swim platform—removable, available in all gel colors
- Heater
- Pressurized hot/cold shower (not available with closed cooling system)
- Pull-up cleats for bow (stainless, flush-mounted)
- Pull-up cleats for stern (stainless, flush-mounted)
- Raised platform
- X-Series option includes graphics, monograms, dash, and applique

Construction

- Extended warranty
- Custom gel coat
- Metal flake gel coat
- Rearrangement of upholstery colors

Wakeboarding and Water Ski Performance

- Perfect Pass Pro Series
- Perfect Pass Cruise
- Perfect Pass Wakeboard Edition
- Binding Blaster soap pump
- KGB system, including saddle tanks
- Removable center seat for walk-thru
- Teak transom saver (not available with fiberglass swim platform)
- Tournament KPH speedometers (two—no-charge option)
- Water temperature gauge (in place of clock)
- ZeroFlex Flyer tower with board racks (two sides)
- Slalom rack (one side)
- Clarion tower speakers (150 watts each) with amp

- Two sets of tower speakers
- Two sets of speakers with lights (kit includes two lights/four speakers)
- Tower light bar with four lights (either two forward and two aft, or four aft)

Trailers

- Canadian-approved trailer
- Galvanized single-axle trailer with disc brakes with swing-away tongue
- Galvanized tandem-axle trailer with disc brakes with swing-away tongue
- Single axle trailer with disc brakes with swing-away tongue
- Tandem axle trailer with disc brakes with swing-away tongue

Spare trailer tire and wheel assembly (available aluminum or galvanized)



X-SERIES

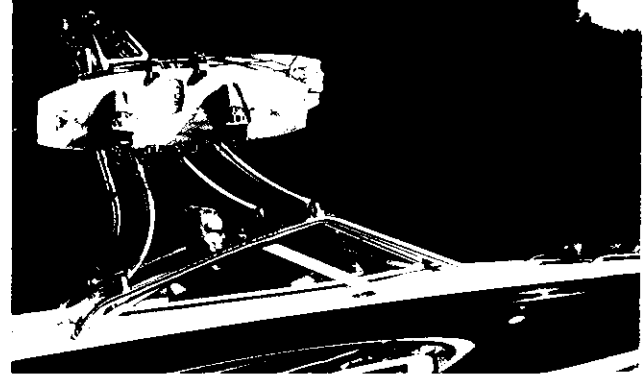

- Length of Boat: 20' 9"**
- Length of Boat with Platform: 22' 6"**
- Width Amidship: 95"**
- Overall Length w/Trailer: 22' 11"**
- W/swing-away tongue folded: 21' 2"**
- Overall Width w/Trailer:**
 - 98" (single-axle)**
 - 100" (tandem-axle)**
- Boat Weight: 3,075 lbs. (approx.)**
- Single Axle Trailer Weight: 900 lbs.**
- Tandem Axle Trailer Weight: 1,050 lbs.**
- Fuel Capacity: 45 gallons**
- Depth at Transom: 27-1/2"**
- Depth Amidship: 26-1/2"**
- Draft: 22-1/2"**
- Capacity: 11 people or 1,620 lbs.**

LAYOUT

- A STERN LIGHT RECEPTACLE
- B BLOWER EXHAUST
- C SWIM PLATFORM
- D FUEL TANK FILLER
- E STORAGE UNDER SUN PAD
- F BATTERY (BEHIND SEAT)
- G THROTTLE SHIFT CONTROL
- H INSTRUMENT PANEL
- I BOW LIGHT
- J GLOVE BOX
- K FIRE EXTINGUISHER (BEHIND SEAT)
- L SKI LOCKER
- M ENGINE COMPARTMENT

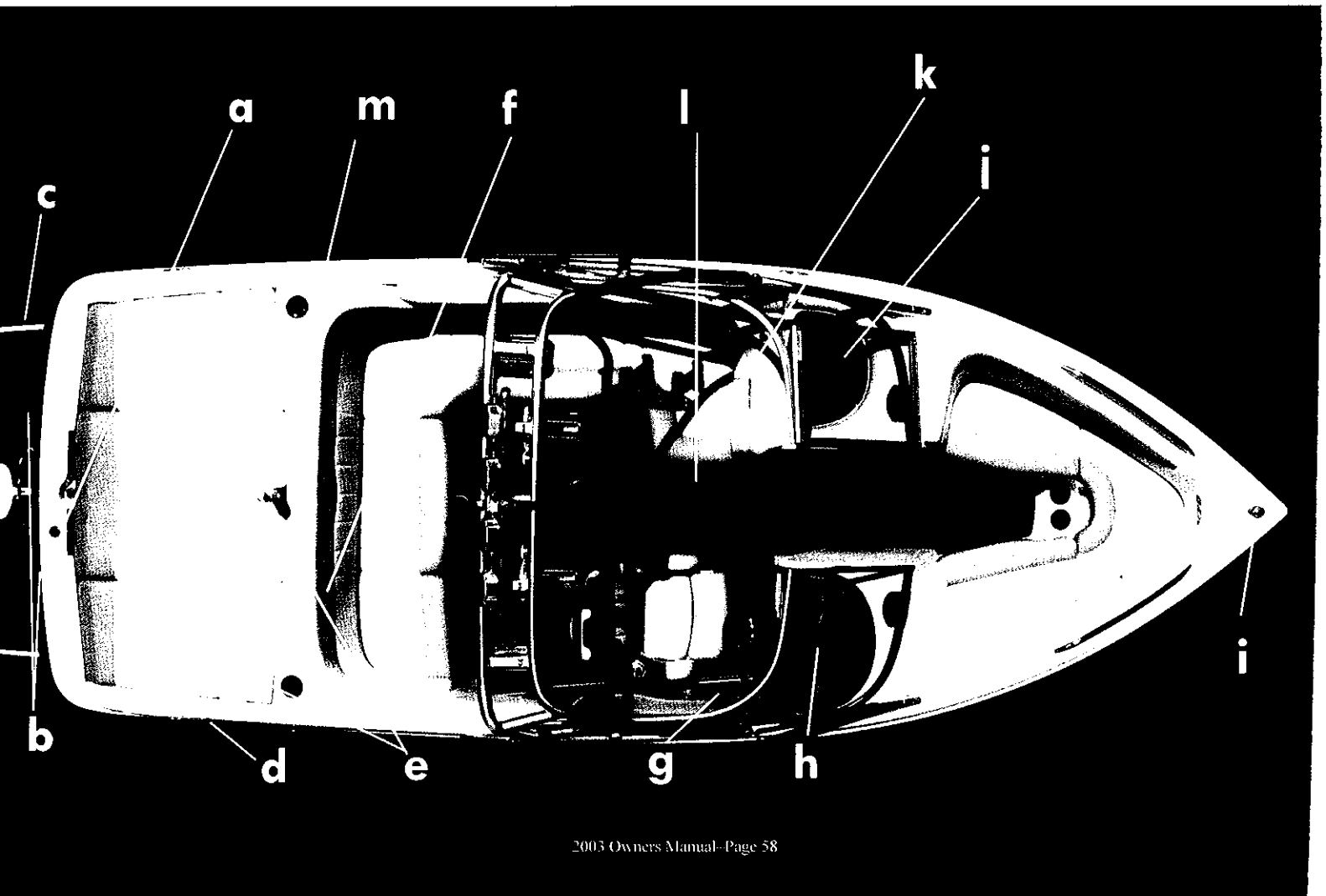

The MasterCraft Movement

The



Standard Equipment

X-10 Package, which includes: Clarion AM/FM CD stereo system with four marine speakers and digital read-out remote, subwoofer and amplifier, ZeroFlex Flyer tower with board racks, monograms, instrumentation and applique (color of dash panel), graphics, KGB with double saddle tank ballast system, black gunnel trim and transom saver.

Propulsion and Systems

MasterCraft Power Vortec Predator 5.7L EFI TBI 350-cubic-inch GM V-8 engine—310 hp
1.56:1 gear ratio transmission
4-blade 14-inch propeller, right-hand rotation
3-year limited engine warranty
Competition throttle control
Dual exhaust system
Dual fuel filtration system
Engine temperature gauge
EZ Change oil kit
Fuel gauge
High-pressure in-tank fuel pump
Low-battery voltage alarm
Oil pressure gauge
Silent Master muffler/exhaust system
Tachometer with hourmeter
Voltmeter

Comfort and Convenience

Two (2) 12-volt DC power outlets
Center drain with threaded drain plug
Companionway walk-thru wind enclosure, canvas
Custom steering wheel, ergonomically designed
Custom dash
Depth finder
Drink holders
MasterView driver's seat
Driver's side armrest
Driver's side storage tray
Glove box
Observer's seat—aft facing
Storage under bow seating
Storage under sun pad, illuminated
Sun pad, three-piece
Teak swim platform, removable
Tilt steering wheel
Transom drain plug
Transom hand rail with integral tow loop

Construction

All hand-laid fiberglass construction
All stainless steel and non-corrosive hardware
Aluminum floorboards
AnchorLok reinforcing plates, steel, aluminum, or HDPE, on all key parts

Bow eye, stainless steel
CelMaster reticulated dry-foam seat construction
Circuit breakers
Cross-linked polyethylene fuel cell
Curved tempered safety glass windshield
Dripless shaft seal system
Exclusive splined propeller and propeller shaft with lock nut
Gel coat tolerances to +/- .005"
Heavy-duty 40 oz. marine carpet with 5-year limited warranty
Insulated and vented engine compartment

Transferable hull-and-structural components limited lifetime warranty
Wiring harness with color-coded and labeled wires—meets ABYC standards
Vinyl—34 oz. premium grade with UV protection and mildew resistors, UV-protected threads

Safety

Bilge blower
Engine warning light and alarm
Fire extinguisher
Flotation exceeding USCG requirements

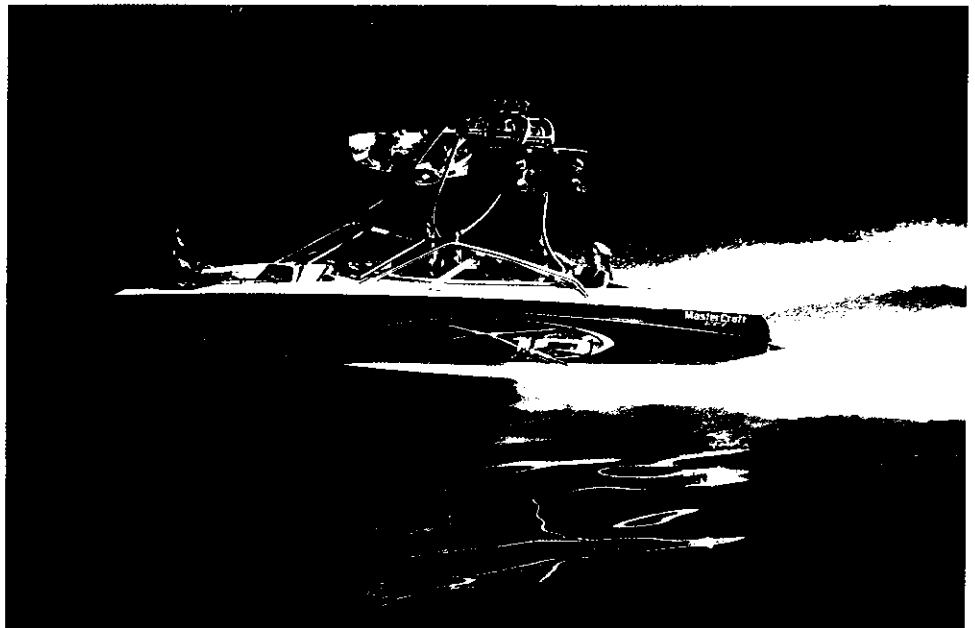

Integrated gel coat striping
M.O.D.S. MasterCraft Oscillation Dampening System for noise and vibration reduction
Magnesium bronze rudder box with o-rings and grease fittings
Magnesium bronze rudder with 1-1/8" stainless steel shaft
Magnesium bronze strut with 8-bolt mounting and dual bearings
MasterCraft custom steering connection with grease fittings
MasterCraft electromechanical custom gauges
Monocoque integrated stringer system
No-spill gas fill
On-water quality assurance testing of every boat
Precision Touch II rack-and-pinion steering system
Pull-up cleats
Pop-up cleats
Rigid PVC rub rail with vinyl insert
Stainless steel bow hand rails
Stainless steel upholstery staples
Steel-reinforced molds
Stern eyes

Fully automatic bilge pump system with manual override
Horn
Inland lighting
NMMA-certified for safety
Safety engine stop switch

Wakeboarding and Water Ski Performance

Adjustable, oversized convex mirror with bracket, removable
USA Water Ski-endorsed Speedometer
Wear-Guard anodized aluminum ski pylon, patented

Optional Equipment

Propulsion and Systems

MasterCraft Power Vortec MCX 5.7L multi-port EFI 350-cubic-inch GM V-8 engine—350 hp
MasterCraft Power Vortec Cadillac LQ9 HO 6.0L multi-port EFI V-8 engine—385 hp

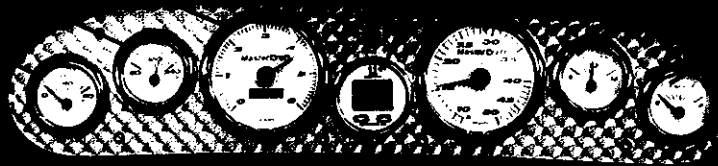

X-10

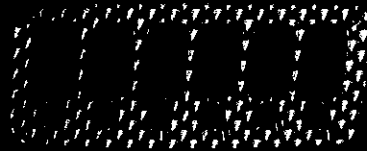

- A BILGE PUMP (2400)
- B BATTERY CHARGER (2400)
- C CAYMAN 100
- D CAYMAN 100
- E CAYMAN 100
- F CAYMAN 100
- G CAYMAN 100
- H CAYMAN 100
- I CAYMAN 100
- J CAYMAN 100
- K CAYMAN 100
- L CAYMAN 100
- M CAYMAN 100
- N CAYMAN 100
- O CAYMAN 100
- P CAYMAN 100
- Q CAYMAN 100
- R CAYMAN 100
- S CAYMAN 100

MasterCraft Power Vortec L18 HO 8.1L EFI
 496-inch GM V-8 engine—425 hp
 Closed cooling system (not available with shower, standard with Cadillac LQ9 engine)
 European package

Canvas and Carpet

Bimini top (dealer-installed)
 Bow Tonneau cover (dealer-installed)
 Cockpit mooring cover (dealer-installed)
 Sun top (dealer-installed)
 Towable boat cover for tower

Comfort and Convenience

Bow filler cushion
 Clarion 6-disc CD changer
 Clarion transom-mounted stereo digital read-out remote control
 Cockpit table, stowable with drink holders
 Depth finder
 Fiberglass swim platform—removable, available in all gel colors
 Heater
 Pressurized hot/cold shower (not available with closed cooling system)

Construction

Extended warranty
 Custom gel coat
 Metal flake gel coat
 Rearrangement of upholstery colors

Wakeboarding and Water Ski Performance

Perfect Pass Cruise
 Perfect Pass Wakeboard Edition
 Binding Blaster soap pump

Slalom rack (one side)
 Clarion tower speakers (150 watts each) with amp
 Two sets of tower speakers
 Two sets of speakers with lights (kit includes two lights/four speakers)
 Tower light bar with four lights (either two forward and two aft, or four aft)

Trailers

Canadian-approved trailer
 Galvanized single-axle trailer with disc brakes with swing-away tongue
 Galvanized tandem-axle trailer with disc brakes with swing-away tongue

Single axle trailer with disc brakes with swing-away tongue
 Tandem axle trailer with disc brakes with swing-away tongue
 Spare trailer tire and wheel assembly (available aluminum or galvanized)



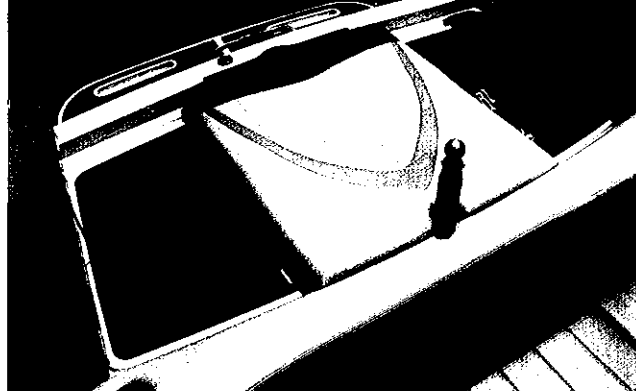

Length of Boat: 22' 8"

Length of Boat with Platform: 24' 5"

Width Amidship: 98"

Overall Length w/Trailer: 24' 7"

W/swing-away tongue folded: 23'

Overall Width w/Trailer: 99"

Boat Weight: 3,300 lbs. (approx.)

Tandem Axle Trailer Weight: 1,180 lbs.

Fuel Capacity: 61 gallons

Depth at Transom: 27-1/2"

Depth Amidship: 26-1/2"

Draft: 22-1/2"

Capacity: 12 people or 1,660 lbs.

LAYOUT

- A STERN LIGHT RECEPTACLE
- B BLOWER EXHAUST
- C SWIM PLATFORM
- D FUEL TANK FILLER
- E STORAGE UNDER SUN PAD
- F BATTERY (BEHIND SEAT)
- G THROTTLE/SHIFT CONTROL
- H INSTRUMENT PANEL
- I BOW LIGHT
- J GLOVE BOX
- K FIRE EXTINGUISHER (BEHIND SEAT)
- L SKI LOCKER
- M ENGINE COMPARTMENT



The MasterCraft Movement

X - 3 0

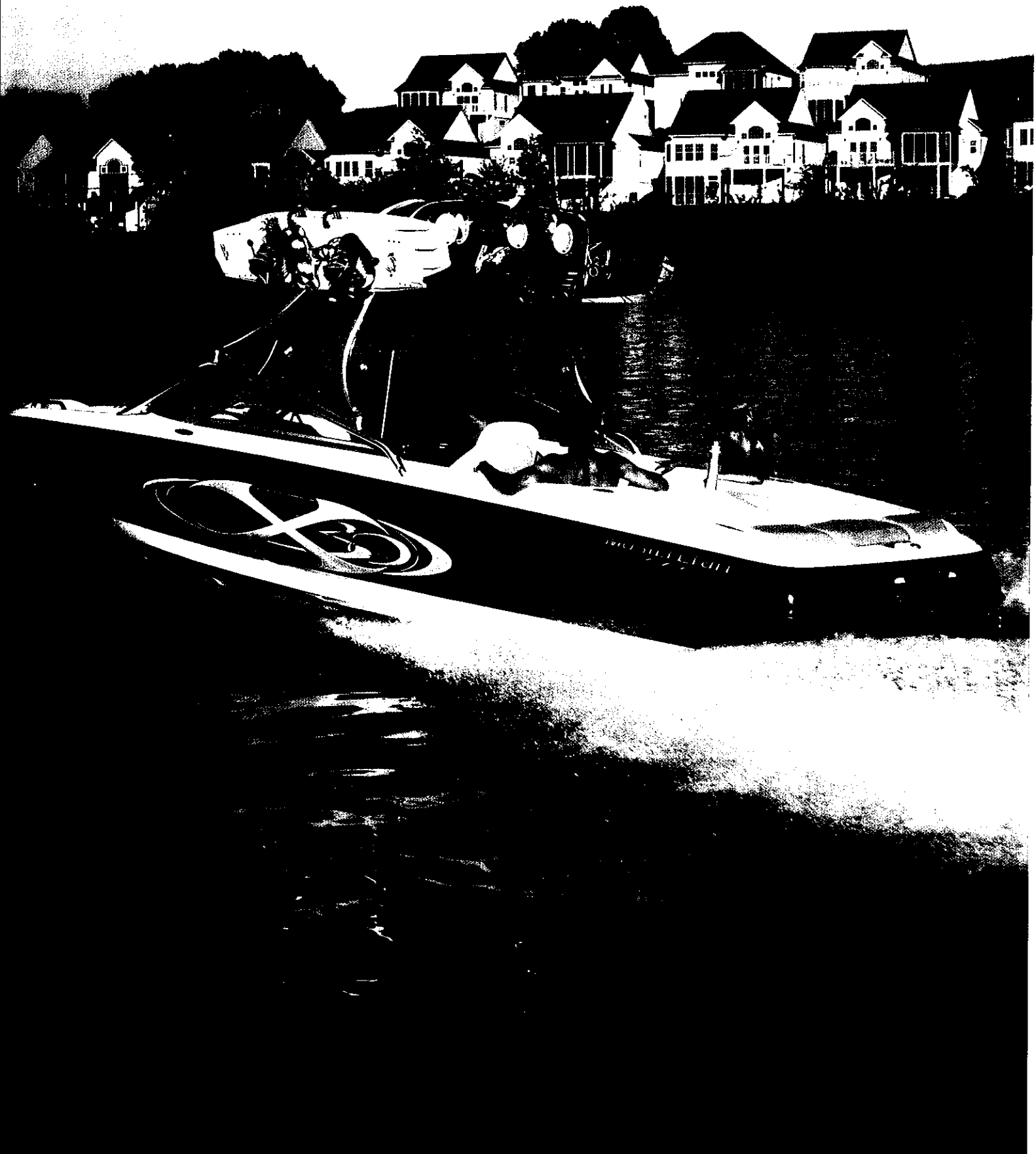

Standard Equipment

X-30 Package, which includes: Clarion AM/FM CD stereo system with four marine speakers and digital read-out remote, subwoofer and amplifier, ZeroFlex Flyer tower with board racks, monograms, instrumentation and applique (color of dash panel), graphics, KGB with double saddle tank ballast system, black gunnel trim and transom saver.

Propulsion and Systems

MasterCraft Power Vortec Predator 5.7L
EFI TBI 350-cubic-inch GM V-8 engine—
310 hp
1.56:1 gear ratio transmission
4-blade 14-inch propeller, right-hand
rotation
3-year limited engine warranty
Competition throttle control
Dual exhaust system
Dual fuel filtration system
Engine temperature gauge
EZ Change oil kit
Fuel gauge
High-pressure in-tank fuel pump
Low-battery voltage alarm
Oil pressure gauge
Silent Master muffler/exhaust system
Tachometer with hourmeter
Voltmeter

Comfort and Convenience

Two (2) 12-volt DC power outlets
Center drain with threaded drain plug
Companionway walk-thru wind enclosure,
canvas
Custom steering wheel, ergonomically
designed
Custom dash
Depth finder
Drink holders
MasterView driver's seat
Driver's side armrest
Driver's side storage tray
Glove box
Observer's seat—aft facing
Storage under bow seating
Storage under sun pad, illuminated
Sun pad, three-piece
Teak swim platform, removable
Tilt steering wheel
Transom drain plug
Transom hand rail with integral tow loop

Construction

All hand-laid fiberglass construction
All stainless steel and non-corrosive
hardware
Aluminum floorboards

AnchorLok reinforcing plates, steel,
aluminum, or HDPE, on all key parts
Bow eye, stainless steel
CelMaster reticulated dry-foam seat
construction
Circuit breakers
Cross-linked polyethylene fuel cell
Curved tempered safety glass windshield
Dripless shaft seal system
Exclusive splined propeller and propeller
shaft with lock nut
Gel coat tolerances to +/- .005"
Heavy-duty 40 oz. marine carpet with 5-
year limited warranty
Insulated and vented engine compartment

Steel-reinforced molds
Stern eyes
Transferable hull-and-structural components
limited lifetime warranty
Wiring harness with color-coded and
labeled wires—meets ABYC standards
Vinyl—34 oz. premium grade with UV
protection and mildew resistors, UV-
protected threads

Safety

Bilge blower
Engine warning light and alarm
Fire extinguisher
Flotation exceeding USCG requirements



Integrated gel coat striping
M.O.D.S. MasterCraft Oscillation
Dampening System for noise and
vibration reduction
Magnesium bronze rudder box with o-
rings and grease fittings
Magnesium bronze rudder with 1-1/8"
stainless steel shaft
Magnesium bronze strut with 8-bolt
mounting and dual bearings
MasterCraft custom steering connection
with grease fittings
MasterCraft electromechanical custom
gauges
Monocoque integrated stringer system
No-spill gas fill
On-water quality assurance testing of
every boat
Precision Touch II rack-and-pinion steering
system
Pull-up cleats
Pop-up cleats
Rigid PVC rub rail with vinyl insert
Stainless steel bow hand rails
Stainless steel upholstery staples

Fully automatic bilge pump system with
manual override
Horn
Inland lighting
NMMA-certified for safety
Safety engine stop switch

Wakeboarding and Water Ski Performance

Adjustable, oversized convex mirror with
bracket, removable
USA Water Ski-endorsed
Speedometer
Wear-Guard anodized aluminum ski
pylon, patented

Optional Equipment

Propulsion and Systems

MasterCraft Power Vortec MCX 5.7L
multi-port EFI 350-cubic-inch GM V-8
engine—350 hp

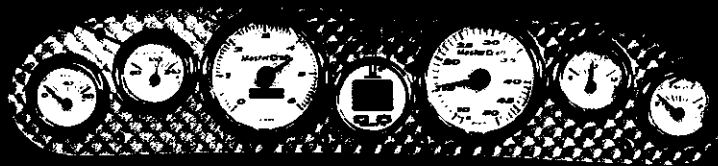

X-30

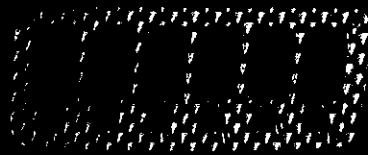

- 24 2001 2001 2001
- 25 2001 2001 2001
- 26 2001 2001 2001
- 27 2001 2001 2001
- 28 2001 2001 2001
- 29 2001 2001 2001
- 30 2001 2001 2001
- 31 2001 2001 2001
- 32 2001 2001 2001
- 33 2001 2001 2001
- 34 2001 2001 2001
- 35 2001 2001 2001
- 36 2001 2001 2001
- 37 2001 2001 2001
- 38 2001 2001 2001
- 39 2001 2001 2001
- 40 2001 2001 2001
- 41 2001 2001 2001
- 42 2001 2001 2001
- 43 2001 2001 2001
- 44 2001 2001 2001
- 45 2001 2001 2001
- 46 2001 2001 2001
- 47 2001 2001 2001
- 48 2001 2001 2001
- 49 2001 2001 2001
- 50 2001 2001 2001

MasterCraft Power Vortec Cadillac LQ9 HO 6.0L multi-port EFI V-8 engine—385 hp
 MasterCraft Power Vortec L18 HO 8.1L EFI 496-inch GM V-8 engine—425 hp
 Closed cooling system (not available with shower, standard with Cadillac LQ9 engine)
 European package

Canvas and Carpet
 Bimini top (dealer-installed)
 Bow tonneau cover (dealer-installed)
 Cockpit mooring cover (dealer-installed)
 Sun top (dealer-installed)
 Towable boat cover for tower

Comfort and Convenience
 Bow filler cushion
 Clarion 6-disc CD changer
 Clarion transom-mounted stereo digital read-out remote control
 Cockpit table, stowable with drink holders
 Fiberglass swim platform—removable, available in all gel colors
 Heater
 Pressurized hot/cold shower (not available with closed cooling system)

Construction
 Extended warranty
 Custom gel coat
 Metal flake gel coat
 Rearrangement of upholstery colors

Wakeboarding and Water Ski Performance
 Perfect Pass Cruise
 Perfect Pass Wakeboard Edition
 Binding Blaster soap pump
 Slalom rack (one side)
 Clarion tower speakers (150 watts each) with amp
 Two sets of tower speakers
 Two sets of speakers with lights (kit includes two lights/four speakers)
 Tower light bar with four lights (either two forward and two aft, or four aft)

Trailers
 Canadian-approved trailer

Galvanized tandem-axle trailer with disc brakes with swing-away tongue
 Tandem axle trailer with disc brakes with swing-away tongue
 Spare trailer tire and wheel assembly (available aluminum or galvanized)

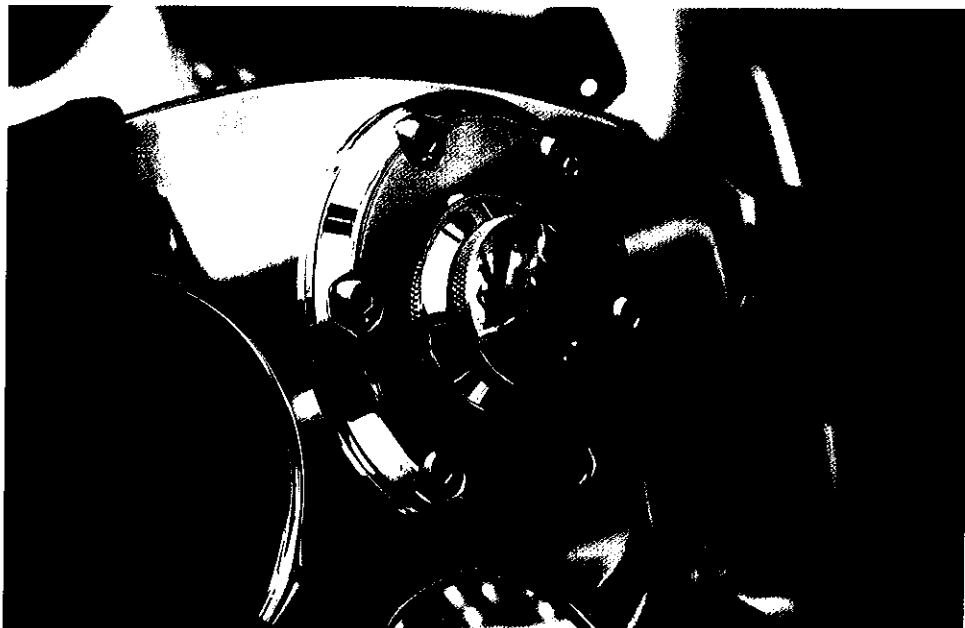

X-SERIES

As this publication went to press, the following was the best information available for the X-Star. Due to on-going efforts to make this the finest boat possible, some changes may have been effected in standard and optional equipment as well as locations.



- Length of Boat: 22'3"**
- Length of Boat with Platform: 24' 5"**
- Width Amidship: 100"**
- Overall Length w/Trailer: 25'**
- W/swing-away tongue folded: 19'**
- Overall Width w/Trailer: 106"**
- Boat Weight: 4,200 lbs. (approx.)**
- Tandem Axle Trailer Weight: 1,200 lbs.**
- Fuel Capacity: 54 gallons**
- Depth at Transom: 28"**
- Depth Amidship: 32"**
- Draft: 28"**
- Capacity: 12 people or 1840 lbs.**

LAYOUT

- A BLOWER EXHAUST
- B SWIM PLATFORM
- C FUEL TANK FILLERS
- D BATTERIES
- E THROTTLE SHIFT CONTROL
- F INSTRUMENT PANEL
- G BOW LIGHTS
- H FIRE EXTINGUISHER (UNDER DASH)
- I ENGINE COMPARTMENT

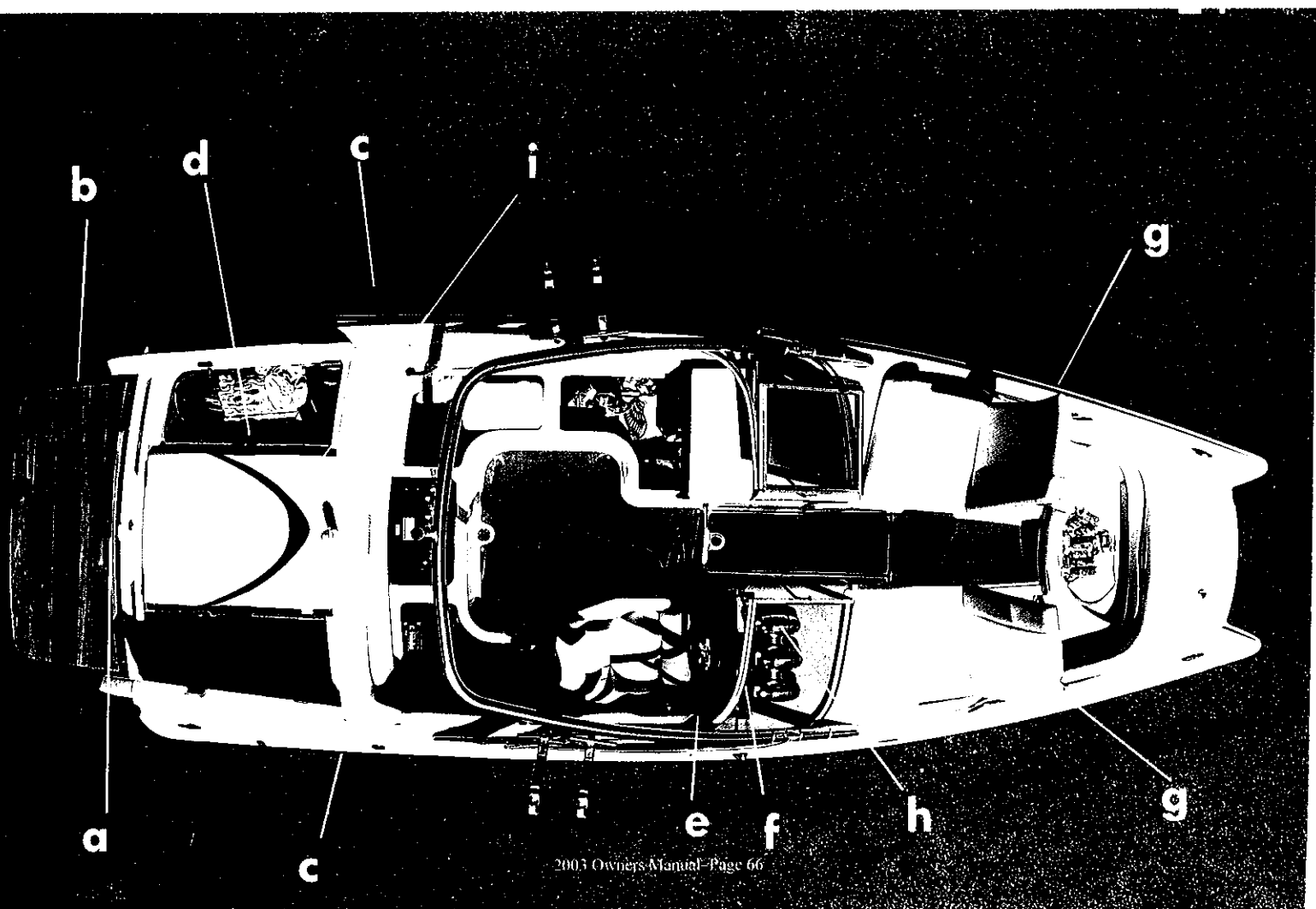

The MasterCraft Movement

The X STAR



Standard Equipment

Propulsion and Systems

MasterCraft Power Vortec Predator 5.7L EFI
TBI 350-cubic-inch GM V-8 engine—310 hp
1.56:1 gear ratio transmission
3-year limited engine warranty
4-blade 14" propeller
Competition throttle control
Depth finder
Dual exhaust system
Dual fuel filtration system
Engine temperature gauge
EZ Change oil kit
Fuel gauge
High-pressure in-tank fuel pump
Low-battery voltage alarm
Oil pressure gauge
Perfect Pass Wakeboard Edition
SilentMaster muffler/exhaust system
Speedometer, tournament
Tachometer with hourmeter
Voltmeter

Comfort and Convenience

Two (2) 12-volt DC power outlets
Anchor locker with four-step ladder
Built in cooler with drain
Center drain with threaded drain plug
Cooler, soft-sided
Clarion AM/FM CD stereo system with six
marine speakers, with remote, amp and
subwoofer
Companionway walk-thru wind enclosure,
canvas
Custom steering wheel, ergonomically
designed
Custom wood grain dash
Driver's side armrest
Forward anchor storage compartment
Forward facing lift back shocked seats
Glove box, water-resistant
MasterView driver's seat
Fifteen (15) drink holders
Storage compartment, dual access
Sun pad, three-piece, easy access
Teak swim platform, removable
Tilt steering wheel
Transom drain plug
Trash receptacle
Transom handrail with integral tow loop

Construction

All hand-laid fiberglass construction
All stainless steel and non-corrosive
hardware
AnchorLok reinforcing plates, steel, aluminum,
or HDPE, on all key parts
Bow eye, stainless steel
CelMaster reticulated dry-foam seat
construction
Circuit breakers
Composite integrated stringer system

Cross-linked polyethylene fuel cell
Curved tempered safety glass windshield
Dripless shaft seal system
Dual no-spill gas fill
Exclusive splined propeller and propeller
shaft with lock nut
Gel coat tolerances to +/- .005"
Heavy-duty 40 oz. Marine carpet with five-
year limited warranty
Insulated and vented engine compartment
Integrated gel coat striping
M.O.D.S. MasterCraft Oscillation Dampening
System for noise and vibration reduction
Magnesium bronze rudder box with o-rings
and grease fittings
Magnesium bronze rudder with 1-1/8"
stainless steel shaft
Magnesium bronze strut with 8-bolt mounting
and dual bearings

Transferable hull-and-structural components
limited lifetime warranty
Trim tabs, electric with electronic read-out
Wiring harness with color-coded and labeled
wires—meets ABYC standards
Vinyl—34 oz. premium grade with UV
protection and mildew resisters,
UV-protected threads

Safety

Bilge blower
Engine warning light and alarm
Fire extinguisher
Fully automatic bilge pump system with
manual override
Horn
Inland lighting
NMMA-certified for safety
Safety engine stop switch



MasterCraft custom steering connection with
grease fittings
MasterCraft electromechanical custom
gauges
On-water quality assurance testing of every
boat
Precision Touch II rack-and-pinion steering
system
Rigid PVC rub rail with stainless steel insert
Six (6) pull-up cleats
Stainless steel bow hand rails
Stainless steel propeller
Stainless steel upholstery staples
Steel-reinforced molds
Stainless steel stern eyes

Wakeboarding and Water Ski Performance

Adjustable, oversized convex mirror with
bracket, removable
Speedometer
ZeroFlex Flyer tower
Hinged/removable center seat for walk-thru
Traking fins, parabolic
Teak transom saver
Ballast system, including saddle tanks with
sending units

Optional Equipment Propulsion and Systems

MasterCraft Power Vortec MCX 5.7L multi-
port EFI 350-cubic-inch GM V-8 engine—
350 hp

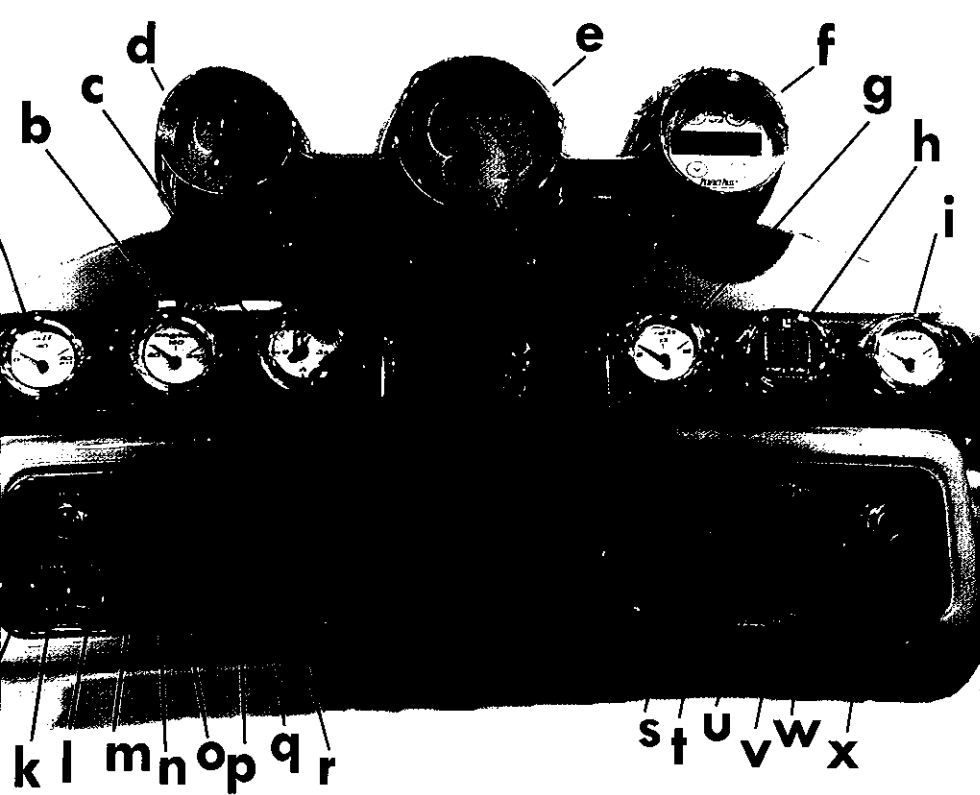

X-STAR

- a OIL GAUGE
- b WATERPUMP GAUGE
- c OIL
- d WATERPUMP
- e TACHOMETER
- f FUEL/GALVAN GAUGE
- g VOLTAGE
- h DISTANCE
- i HOUR GAUGE
- j HORN
- k OVER/DOOR RELEASE SWITCH
- l BATTERY CHARGE/DOOR RELEASE SWITCH
- m GUN/STATION SWITCH
- n GUN/STATION SWITCH
- o BLOWER SWITCH
- p ACC (A/C)
- q ACC (A/C)
- r ACC (A/C)
- s TOWER LIGHT SWITCH
- t TOWER LIGHT SWITCH
- u BLOWER SWITCH
- v HORN SWITCH
- w TRAY/ANCHOR LIGHT SWITCH
- x IGNITION SWITCH

MasterCraft Power Vortec Cadillac LQ9 HO
 6.0L multi-port EFI V-8 engine—385 hp
MasterCraft Power Vortec L18 HO 8.1L EFI
 496-inch GM V-8 engine—425 hp
 Closed cooling system
 European package
 Battery, installed
 Bow thruster

Canvas and Carpet
 Bimini top (dealer-installed)
 Bow tonneau cover (dealer-installed)
 Cockpit mooring cover (dealer-installed)
 Towable boat cover
 Towable ZeroFlex Flyer tower mooring cover

Comfort and Convenience
 Bow filler cushion
 Center sun deck filler cushion
 Cockpit rear filler cushion
 Clarion transom-mounted stereo digital read-out remote control
 Cockpit table, stowable with drink holders
 Heater
 Pressurized hot/cold shower (not available with closed cooling system)
 Swim platform, fiberglass

Construction
 Extended warranty
 Custom gel coat
 Metal flake gel coat
 Rearrangement of upholstery colors

Wakeboarding and Water Ski Performance
 Binding Blaster soap pump
 Board racks (two sides)
 Clarion tower, speakers
 Perfect Pass Pro Wakeboard
 Two sets of tower speakers
 Two sets of speakers with lights (kit includes two lights/four speakers)
 Tower with board racks
 Tower light bar with four lights (either two forward and two aft, or four aft)
 Tower mirror attachment

Trailer
 Canadian-approved trailer
 Galvanized tandem-axle trailer with disc brakes with swing-away tongue
 Tandem axle trailer with disc brakes with swing-away tongue
 Spare trailer tire and wheel assembly (available aluminum or galvanized)

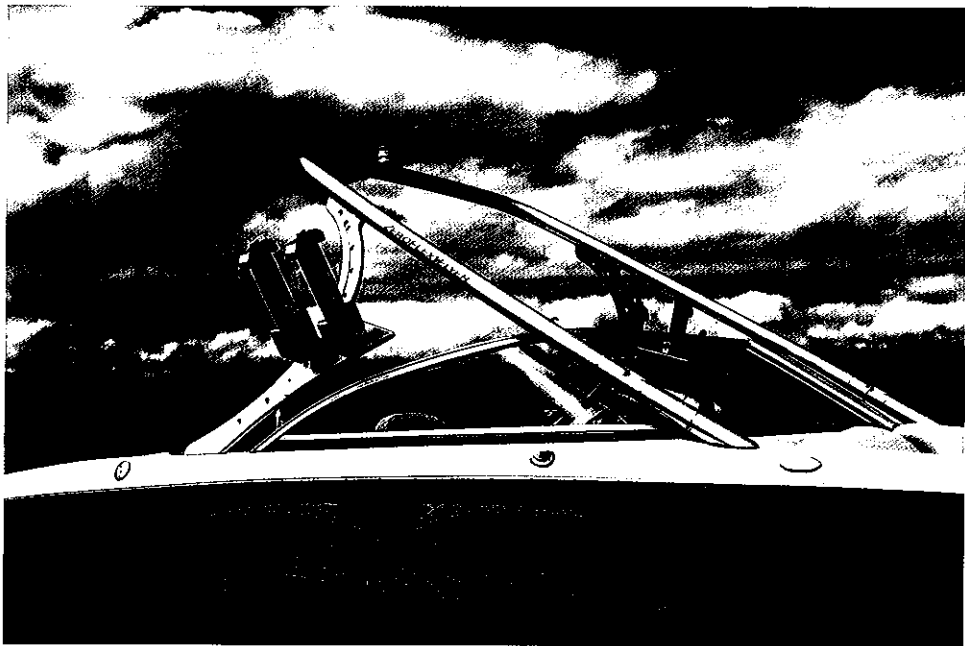

indicators

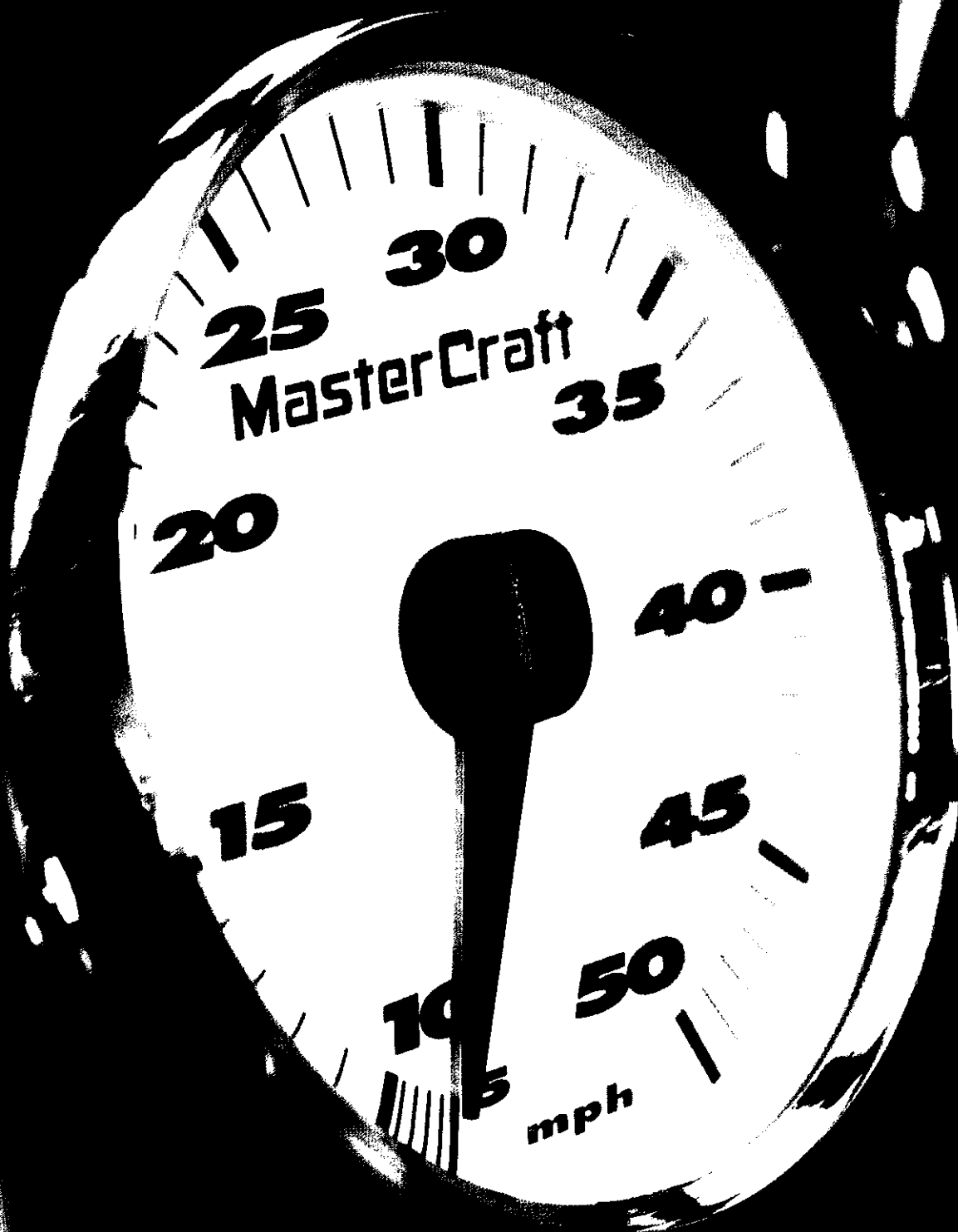

The information provided here will help you understand the controls and indicators. However, you should review the Operations and Maintenance Manual prior to launching your boat for the first time.

The Operations and Maintenance Manual provides in-depth information, including how to properly break-in your boat, start and operate it while new, and later how to maintain your boat so that it will give you years of trouble-free enjoyment. **Failure to review the information contained in that Manual, as well as the Owners Manual, can result in injury or death to the driver and/or passengers. Also, failure to adhere to the directions in these two Manuals may void the boat, power train and trailer warranties!**

Speedometer . . . The speedometer indicates the forward speed of the boat in miles per hour (*unless your boat is equipped with the kilometers per hour available in the European Package*). Tournament boats feature dual speedometers, which are required for some tournaments in case of a failure during a run. The speedometer calibration switches are located on the lower starboard panel on these boats.

Because the MariStar line and some X-Series boats also serve as pleasure boats they are equipped with a single speedometer, and the calibration switch is located on the middle starboard panel on most dashes.

For tournament use and practice, accurate speedometer readings are a must. Even if you are not involved in pulling tournament skiers, you may be concerned about having accurate readings.

To calibrate the speedometer you need an accurately measured course of 850 feet and a certified stopwatch accurate to within one-thousandth of a second. To calibrate to AWSA official-tournament rules:

- Approach the course at an indicated 36 miles per hour (MPH). Hold the speed steady and have an observer check the course time with a stopwatch.

- If the course time is between 15.88 and 16.28 seconds, no adjustments are necessary.

- If the course time is not within tolerance, press up or down on the calibration rocker switch to adjust the calibration.

Tachometer/Engine Hourmeter . . . The tachometer indicates the engine speed in crankshaft revolutions per minute (RPM). Propeller shaft RPM is the same as the engine except for boats equipped with the PowerSlot 1.5-to-1 ratio package or a V-drive gear, in which case propeller shaft RPM is less than that of the engine RPM. The engine hourmeter registers accumulated engine operating time. Use the hourmeter to keep accurate logs for scheduled maintenance.

Fuel Gauge . . . The readings are only approximate on the fuel gauge. The gauge is activated with the ignition switch. Rocking motion of the boat during normal operation will cause fluctuation of the fuel gauge. For a more accurate reading, make sure that the boat is level and at rest. When the boat is placed into initial operation, do not run the boat below an indicated quarter of a tank until you have re-fueled several times and have a sense of how long you can operate the boat on the fuel available. Extending usage beyond the known capability may cause the boat to run out of fuel and strand you away from the shore.

Although it may be possible to see fuel in the bottom of the fuel tank, you still may not be able to operate the boat. The fuel pick-up system was designed to avoid introducing the water and debris that inevitably accumulates in the bottom of the tank. Rather than relying on visual inspection, you should pay attention to the fuel gauge.

Temperature Gauge . . . The temperature gauge indicates the cooling water temperature inside the engine as measured in degrees Fahrenheit.

The normal operating temperature will range from 140 degrees to 190 degrees. Engines with electronic fuel injection also

have a control circuit inside the engine control module that will cause the engine to run at reduced speeds if the module senses that the engine is running too hot. If you notice that your speed has reduced during normal operation without reducing the throttle, monitor your temperature gauge. If the gauge indicates excessive temperatures during operation, slow down immediately and turn off the ignition. *This indicates an engine problem that needs to be checked by the dealer!*

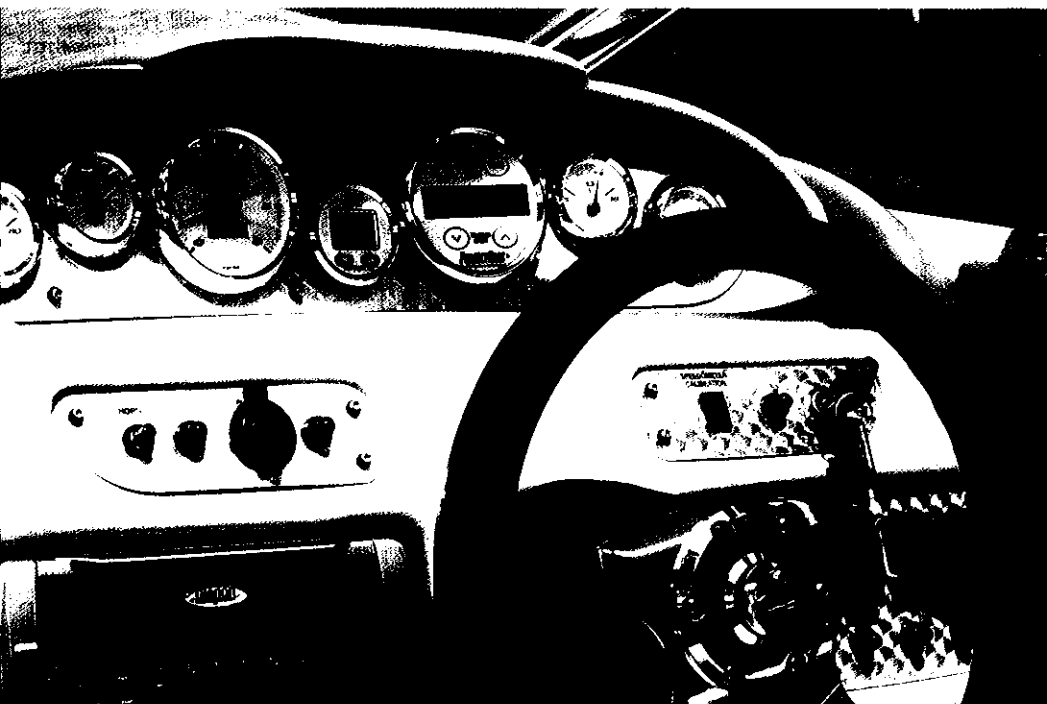



Caution: Continuing to operate the boat while the temperature is above normal operating parameters may cause serious damage to your engine.

Note: Damage to your engine from neglected action while running too hot can be costly. It is not covered by your warranty!

Engine Oil Pressure Gauge . . . The engine oil pressure gauge indicates the pressure of the lubricating oil inside the engine. The average pressure ranges are between 6 pounds-per-square-inch (PSI) at 1000 RPM to 40 PSI or more at cruise range speeds. A reading of pressure below 5 PSI at 1000 RPM may be caused by a low oil level or other potentially serious problems that result in low oil pressure. If you experience low oil pressure, stop your engine immediately and check your oil level before operating again.

Caution: Do not continue to run the engine if the oil pressure is low. If you do, the engine can become so hot that it—or surrounding components—could catch fire. You or others could be burned and the boat seriously damaged. Check your oil level before operating again or have your boat serviced by your local MasterCraft dealer.

Note: Damage to your engine from neglected oil problems can be costly. Such damage is not covered by your warranty!

Check Engine Light . . . The red malfunction indicator Check Engine light is operated from an on-board computer that monitors the operation of your fuel, ignition and engine control systems.

On some models, the Check Engine light should come on when the key is in the ON position and the engine is not running. This is a check to show you that it is working. If it does not come on at all, have it repaired by your MasterCraft dealer right away.

If it stays on—or comes on while you are operating your boat—the computer is indicating that you have a problem. You

should take your boat to your MasterCraft dealer for immediate service.

Notice: If you continue to operate your boat with this light on, you could adversely affect the emission control systems on the engine. You could also experience poor fuel economy, and your engine may not run as smoothly. This could lead to costly repairs not covered by your warranty.

Low Voltage Battery Alarm . . .

2003 models feature a low-voltage battery alarm. In the event that the stereo was functioning when the boat was not ON and running, the voltage drain on the battery can result in difficulties re-starting the boat. To avoid this situation, when the voltage level falls to 11.5 volts, the system

will shut down the stereo system and sound the alarm for a period of two minutes to give boaters ample time to adjust.

Other Alarms . . . Additional alarms assist the owner in monitoring the boat's condition. Sensors check the oil pressure, engine and transmission temperatures. If the system detects readings outside the acceptable range, the system shuts off the stereo (if on) and sounds the alarm for a period of one minute. Even after the alarm ceases, the Check Engine light will remain on.

This signals the need to return to shore and seek assistance from your dealer as soon as possible to diagnose and, if necessary, repair the issue.

Ignition Switch . . . Never leave the ignition switch in the RUN position without the engine running; this will prevent the natural discharge of the battery and cause damage to the starter solenoid.

Safety Switch . . . The emergency engine safety switch, called the lanyard, is an ignition cut-off switch designed to stop the engine in the event of an operator being thrown from position or moving too far from the helm.

The lanyard is equipped with a hook on one end for attachment to your clothing, and the opposite end has a slide that fits over the switch. Be sure that the slide is firmly attached to the switch before starting. The switch is located on the throttle control box. If the slide is left off or loose, the engine will crank but will not start.

Warning: The safety switch lanyard must be attached to the operator whenever the engine is started. Failure to do so may cause serious injury or death.

Blower Switch . . . A two-position rocker switch activates the engine box ventilation blower. Push the top half of the switch to turn the blower ON.

Note: The blower must operate for a minimum of four (4) minutes before starting the engine at any time. The blower must also be operated during idle and slow-speed running, but is not necessary at cruising speed.

Warning: Failure to operate the blower as instructed could cause improper ventilation of the boat engine and bilge areas. Fuel vapors can accumulate in this area and cause a fire or explosion!

Manual & Automatic Bilge Pump Switch . . . A three-position rocker switch activates the bilge pump. Push the top half of the switch to turn the bilge pump to the manual ON position. Press the switch down to activate the bilge pump for automatic mode while the boat is underway. When the switch is centered, the bilge pump is OFF. The bilge pumps on all V-drive models will be in the automatic mode when the ignition key is turned ON.

Circuit Breakers . . . All major boat circuits are protected from shorting and overload by re-settable circuit breakers. If a problem develops with one of the following circuits, switch OFF the circuit and wait about one minute. Then push the appropriate breaker button fully and switch ON the circuit. If the circuit continues to trip, there is a problem somewhere that must be checked immediately. See your MasterCraft dealer.

See your **Operations and Maintenance Manual** for additional details regarding the main and supplemental breakers located in the boat.

Shift/Throttle Control . . . A one-hand, single-lever control operates as both a gear shifter and a throttle. The lever automatically locks in the neutral position (straight up and down) for safety. The lever can be moved from neutral only by raising the lifter under the ball knob. Shifting is accomplished by moving the lever into the first 45 degrees of travel.

Moving the lever forward engages the running gear; moving it back from center puts the drive train into reverse. By advancing the lever beyond 45 degrees you move from the shifting range to the throttle range.

Never attempt to shift without the engine running!

The shift mechanism of this control can be temporarily disengaged by pushing in the black button in the side of the throttle handle. This allows the engine to increase RPM in neutral during warm-up.

Ballast System . . . Many MasterCraft boats in recent years have incorporated ballast systems to increase boating enjoyment through wakeboarding. A variety of systems have been used, and as a result there is no single set of instructions. Boat owners **MUST** follow the instructions in the current *Operations and Maintenance Manual*. Your dealer should also explain the proper use and maintenance of your ballast system as this is critical to future enjoyment of your boat. **Pay particular attention to the winterizing and spring preparation instructions.**

Caution: Failure to follow the ballast preparation and winterization instructions can result in serious damage to the boat and may even pose a threat to personal safety. Failing to following instructions may also void the boat's warranties.

Warning: Use common sense when operating your boat. This includes skiing, wakeboarding, swimming or any other use involving the boat. Care should be taken to avoid the swim platform area unless the boat is turned OFF. Exhaust fumes are emitted from the exhaust flap area



of the transom, immediately below the swim platform. No one should ever be on the swim platform while the engine is in operation, nor should individuals ever be towed while holding on to the swim platform or transom.

MasterCraft also notes that individuals should be outfitted with PFDs (Personal Flotation Devices).

Adhering to this warning can save lives and avoid serious injury or illness.



MasterCraft Power
 Vortec Predator 5.7L
 EFI TBI 350-cubic-inch
 GM V-8 engine

Displacement	350 C.I.D. (5.7 litres)—310 horsepower
Bore	4.00"
Stroke	3.48"
Compression Ratio	9.4:1
Compression Pressure	100 PSI minimum
Maximum Allowable Compression Variation	Highest to lowest within 70%
RPM Range at WOT	4400-4800 RPM
Oil Pressure (Hot)	20 PSI at 2000 RPM
Propshaft Rotation	LH
Fuel Requirement	89 Octane
Fuel Pressure: Operating Pressure	28-31 PSI
Fuel Pump Volume	1 pint in 20 seconds
Type of Fuel Induction	Marine Electronic Fuel Injection Throttle Body Type
Electrical System	12 Volt
Ignition Type	Distributor HEI
Electronic Control Module	Delco Electronics Waterproof Marine Controller (M.E.F.I. 4)
Alternator Output Rating	70 amps at 2000 RPM
Thermostat	143 degrees
Spark Plug Type	AC 41-9332 or ACMR43LTS
Recommended Plug Gap	0.045"
Firing Order	1-8-4-3-6-5-7-2
Minimum Battery Rating	650 cold cranking amps for 30 sec at 0 degrees Fahrenheit or better
Oil Capacity	4-5 quarts with filter change—verify with dipstick
Oil Type	SAE 15W40, SJ, CG4, CH4
Oil Filter Type	PF25 or PZ3
Transmission Fluid Capacity	1 1/2 to 2 qts with 1:1 transmission; 2 1/2 to 3 qts with 1.5:1 transmission; 4.4 qts with V-drive
Initial Timing	10 degrees BTDC at 1000 fixed RPM
Total Ignition Advance	Varies as a function of input information

MasterCraft Power
 Vortec MCX 5.7L
 multi-port EFI
 350-cubic-inch
 GM V-8 Engine



Displacement	350 C.I.D. (5.7 litres)—350 horsepower
Bore	4.00"
Stroke	3.48"
Compression Ratio	9.4:1
Compression Pressure	100 PSI minimum
Maximum Allowable Compression Variation	Highest to lowest within 70%
RPM Range at WOT	4800-5200 RPM
Oil Pressure (Hot)	20 PSI at 2000 RPM
Propshaft Rotation	LH
Fuel Requirement	89 Octane minimum
Fuel Pressure: Operating Pressure	43-45 PSI
Fuel Pump Volume	1 pint in 20 seconds
Type of Fuel Induction	Marine Electronic Fuel Injection Direct Port Type
Electrical System	12 Volt
Ignition Type	Distributor HEI
Electronic Control Module	Delco Electronics Waterproof Marine Controller (M.E.F.I. 4)
Alternator Output Rating	70 amps at 2000 RPM
Thermostat	160 degrees
Spark Plug Type	AC 41-932 or AC MR43LTS
Recommended Plug Gap	0.045"
Firing Order	1-8-4-3-6-5-7-2
Minimum Battery Rating	650 cold cranking amps for 30 sec at 0 degrees Fahrenheit or better
Oil Capacity	4-5 quarts with filter change—verify with dipstick
Oil Type	SAE 15W40, SJ, CG4, CH4
Transmission Fluid Capacity	1 ½ to 2 qts with 1:1 transmission; 2 ½ to 3 qts with 1.5:1 transmission; 4.4 qts with V-drive
Initial Timing	10 degrees BTDC at 1000 RPM fixed; factory set—not field adjustable
Total Ignition Advance	Varies as a function of input information



MasterCraft Power
 Vortec Cadillac LQ9
 HO 6.0L multi-port
 EFI V-8 Engine

Displacement	364 C.I.D. (6.01 litres)—375 horsepower at 5200 RPM
Bore	3.898"
Stroke	3.623"
Compression Ratio	9.4:1
Cylinder Head Material	Aluminum
Block Material	Cast Iron
Compression Pressure	100 PSI minimum
Maximum Allowable Compression Variation	Highest to lowest within 70%
RPM Range at WOT	5200-5600 RPM
Oil Pressure (Hot)	20 PSI at 2000 RPM
Fuel Requirement	89 Octane (R+M)/2 (RFG acceptable)
Fuel Pressure: Operating Pressure	43-53 PSI
Fuel Pump Volume	1 pint in 20 seconds
Type of Fuel Induction	Marine Electronic Fuel Injection Phased Port Type
Electronic Control Module	Delco Electronics Waterproof Marine Controller (MEFI 4)
Ignition System	Coil near plug
Alternator Output Rating	70 amps at 2000 RPM
Thermostat	160 degrees
Spark Plug Type	AC41-952
Recommended Plug Gap	0.050"
Firing Order	1-8-7-2-6-5-4-3
Minimum Battery Rating	650 cold cranking amps for 30 sec at 0 degrees Fahrenheit or better
Oil Capacity	5.5 quarts with filter change —verify with dipstick
Oil Type	SAE 15W-40, SJ, CG4, CH4
Oil Filter Type	AC PF 25
Transmission Fluid Capacity	2 1/2 to 3 qts with 1.5:1 transmission; 4.4 qts with V-drive transmission
Initial Timing	Factory-set and computer-controlled—not field adjustable
Total Ignition Advance	Varies as a function of input information
Cooling System—Engine	Full Fresh Water (closed) 12 qt. 50/50 Propylene Glycol & Water
Cooling System—Engine Oil/Transmission	Raw Water—Full Flow Tandem
Pump Capacity—Raw	25 GPM
Pump Capacity—Circulating	104 GPM



MasterCraft Power

Vortec L18 HO 8.1L

EFI 496-cubic-inch

GM V-8 Engine

Displacement	496 C.I.D. (8.1 Litres)—425 horsepower
Bore	4.25"
Stroke	4.37"
Compression Ratio	9.1:1
Acompression Pressure	100 PSI minimum
Maximum Allowable Compression Variation	Highest to lowest within 70%
RPM Range at WOT	5000 - 5400 RPM
Oil Pressure (Hot)	10 PSI minimum at 2000 RPM
Propshaft Rotation	LH
Fuel Requirement	89 Octane
Fuel Pressure: Operating Pressure	TBD
Fuel Pump Volume	TBD
Type of Fuel Induction	Marine Electronic Fuel Injection Direct Port Type
Electrical System	12 Volt
Ignition Type	Coil near plug
Electronic Control Module	Delco Electronics Waterproof Marine Controller (M.E.F.I. 4)
Alternator Output Rating	70 amps at 2000 RPM
Thermostat	160 degrees
Spark Plug Type	AC 41-983
Recommended Plug Gap	0.050"
Firing Order	1-8-7-2-6-5-4-3
Minimum Battery Rating	650 cold cranking amps for 30 sec at 0 degrees Fahrenheit or better
Oil Capacity	8 quarts with filter change—verify with dipstick
Oil Type	SAE 15W-40, SJ, CG4, CH4
Oil Filter Type	PF454
Transmission Fluid Capacity	4 quarts with V-drive transmission; 2 ½ to 3 quarts with 1.5:1 transmission; 4.4 qts with V-drive
Initial Timing	10 degrees BTDC at 1000 fixed RPM; Factory Set—Not Field Adjustable
Total Ignition Advance	Varies as a function of input information

Shaft and Propeller Combinations

	<i>Engine</i>	<i>Transmission</i>	<i>Shaft</i>	<i>Propeller</i>
ProStar 190 & 197, X-7	TBI	1:1	49"x1 1/8"	13"x14"
ProStar 190 & 197, X-7	TBI	1.5:1	51"x1 1/8"	14"x20"
ProStar 190 & 197, X-7	MCX	1:1	49"x1 1/8"	13"x13"
ProStar 190 & 197, X-7	MCX	1.5:1	51"x1 1/8"	14"x18"
ProStar 190 & 197, X-7	6.0L	1:1	49"x1 1/8"	13"x14" SS
ProStar 190 & 197, X-7	8.1L	1.5:1	48 1/8"x1 1/8"	14"x20" SSI
ProStar 209, X-9	TBI	1:1	47 1/2"x1 1/8"	13"x14"
ProStar 209, X-9	TBI	1.5:1	49 1/2"x1 1/8"	14"x20"
ProStar 209, X-9	MCX	1:1	47 1/2"x1 1/8"	13"x13"
ProStar 209, X-9	MCX	1.5:1	49 1/2"x1 1/8"	14"x18"
ProStar 209, X-9	6.0L	1:1	47 1/2"x1 1/8"	13"x14" SS
ProStar 209, X-9	6.0L	1.5:1	47 1/2"x1 1/8"	14"x20" SS
ProStar 209, X-9	8.1L	1.5:1	45 1/2"x1 1/8"	14"x20" SSI
X-2	TBI	1.5:1	52 1/2"x1 1/8"	14"x20"
X-2	MCX	1.5:1	52 1/2"x1 1/8"	14"x18"
MariStar 210, X-10	TBI	1.5:1	52 1/2"x1 1/8"	14"x20"
MariStar 210, X-10	MCX	1.5:1	52 1/2"x1 1/8"	14"x18"
MariStar 210, X-10	6.0L	1.5:1	52 1/2"x1 1/8"	14"x20" SS
MariStar 210, X-10	8.1L	1.5:1	52 1/2"x1 1/8"	14"x20" SS
MariStar 230, X-30	TBI	1.5:1	52 1/2"x1 1/8"	14"x20"
MariStar 230, X-30	MCX	1.5:1	52 1/2"x1 1/8"	14"x18"
MariStar 230, X-30	6.0L	1.5:1	52 1/2"x1 1/8"	14"x20" SS
MariStar 230, X-30	8.1L	1.5:1	52 1/2"x1 1/8"	14"x20" SS
MariStar 280 VLD	6.0L	1.5:1	52 1/2"x1 1/8"	14"x20" SS
MariStar 280 VLD	8.1L	1.5:1	52 1/2"x1 1/8"	14"x20" SS
X-Star	TBI	1.5:1	52 1/2"x1 1/8"	14"x20"
X-Star	MCX	1.5:1	52 1/2"x1 1/8"	14"x18"
X-Star	6.0L	1.5:1	52 1/2"x1 1/8"	14"x20" SS
X-Star	8.1L	1.5:1	52 1/2"x1 1/8"	14"x20" SS



MASTERCRAFT LIMITED WARRANTY STATEMENT

1. Limited Warranty and Term.

MasterCraft warrants to the original retail purchaser that the following components of each new boat shall be free from material defects in materials and workmanship to the extent set forth below, under normal use and when operated and maintained in accordance with MasterCraft's instructions, for the period indicated:

- (a) **Deck, Hull, Liner and Stringers**—From the date of the original retail purchase, the deck, hull, liner and stringer system (collectively, "Structural Components") is warranted for as long as the original purchaser owns the boat.
- (b) **Gel Coat**—All exterior gel coat surfaces are covered against structural defects under the Limited Warranty and as listed under gel coat manufacturer guidelines. Due to the environmental and customer care effects on gel coat, cosmetic concerns must be addressed with your Customer Service representative at the dealership prior to communication with the factory. Examples are blisters, scratches, discoloration or fade issues. Stress crazing is not covered but will be reviewed as a customer good-will item on a case-by-base basis. Any issue determined to be an application/installation item will be reviewed in advance to determine warranty coverage or not. Any gel coat issues will require digital, video or 35mm photos that clearly shows the reported issue.
- (c) **Engine/Transmission**—Three (3) years from the date of the original retail purchase of the boat. The engines used in MasterCraft boats are supplied by Indmar Products Company, Inc., in Millington, Tennessee ("Indmar"). Indmar's three-year warranty on the engine and transmission is administered at the MasterCraft factory and is subject to the terms and conditions set forth below under "Power Train Warranty."
- (d) **Other Component Parts**—One (1) year from the date of the original retail purchase of the boat.
- (e) **Trailer and Trailer Component Parts**—One (1) year from the date of the original retail purchase of the boat.

2. Warranty Conditions, Limitations and Exclusions.

MasterCraft boats are manufactured by trained craftspeople from high-quality materials and components. However, conditions outside MasterCraft's control require specific limitations on, and exclusions from, coverage under this warranty. The Limited Warranty on the structural components set forth in **Section 1(a)** above does not cover or include the gel coat, including any discoloration, blisters, bubbles or cracks of the gel coat, or any other components fastened or applied to the hull or deck. Furthermore, the Limited Warranty set forth in Section 1 (including all sub-sections) above does not cover the following:

- (a) damage caused by misuse, negligence, accident, collision or impact with any object;
- (b) damage caused by any improper alteration or modification to the boat or any of its component parts or accessories, including damage resulting from alteration, modification, repair or replacement in such a way as to increase the cubic-inch capacity or horsepower output of the engine and boat as originally manufactured;
- (c) damage caused by the use of customer-applied chemicals or accidental spills;
- (d) damage caused by the use of customer-applied chemicals or accidental spills;
- (e) damage caused by failure to maintain the boat in accordance with the maintenance provisions in the *Operations and Maintenance Manual* or improper maintenance of the boat;
- (f) damage resulting from the use of the boat for any racing, speed, commercial competition or performance demonstration;
- (g) damage resulting from use of the boat for rental, commercial or industrial purposes;
- (h) damage to hardware and other components fastened or adhered to the hull, deck or liner;
- (i) damage caused by fire, theft, freezing, vandalism, explosion, lightning, hail storms, flooding, or other natural disaster;



- (j) damage to any components parts and accessories not manufactured by MasterCraft, including but not limited to the engine, drive train, transmission, propeller, shift and throttle control levers and cables, pumps, blowers, windshields, canvas, upholstery, towers and accessories, instrumentation and steering systems; however, such items may be warranted by the individual manufacturer, and if possible, MasterCraft will provide the owner with a copy of the manufacturer's warranty;
 - (k) damage to the gel coat due to the owner's failure to reasonably maintain the gel coat finish, including, without limitation, discoloration of the gel coat, as this condition is caused by improper care and maintenance; however, fading and chalking of the gel coat above the water line will be covered, provided the gel coat has been appropriately maintained;
 - (l) defects caused by improper, non-MasterCraft trailer;
 - (m) damage to gel coat caused by improper support of boat on davits, hoist system or boat lift of any kind;
 - (n) in-water storage without proper barrier coat and bottom paint;
 - (o) damage to the trailer and its parts or components due to abrasions, rock chips, rust, improper care or maintenance, or use in salt or brackish water; the finishes of galvanized trailers, which are designed for use in salt or brackish water, are warranted to be free from damage resulting from use in salt or brackish water for one (1) year;
 - (p) damage caused by dealer-installed options or accessories;
 - (q) damage caused by consumer-installed options or accessories;
- and/or

- (r) all warranted coverage will expire after ninety (90) days on boats used for commercial purposes.

3. Disclaimer of Implied Warranties.

THE EXPRESS LIMITED WARRANTY SET FORTH HEREIN IS IN LIEU OF ALL OTHER WARRANTIES AND REPRESENTATIONS, EXPRESS OR IMPLIED, AND TO THE MAXIMUM EXTENT PERMITTED BY APPLICABLE LAW, MASTERCRAFT DISCLAIMS, AND THE OWNER HEREBY EXPRESSLY WAIVES, ANY AND ALL OTHER WARRANTIES OR REPRESENTATIONS OF ANY KIND OR NATURE, INCLUDING, BUT NOT LIMITED TO, IMPLIED WARRANTIES OR MERCHANTABILITY AND FITNESS FOR A PARTICULAR PURPOSE. THIS LIMITED WARRANTY GIVES YOU SPECIFIC LEGAL RIGHTS. YOU MAY HAVE OTHERS, WHICH VARY FROM JURISDICTION TO JURISDICTION.

4. Limitation of Liability.

- (a) **Consequential Damages.** This warranty is for the benefit of the owner and MasterCraft, and shall not create or evidence any right in any third party. To the maximum extent permitted by applicable law, in no event shall MasterCraft be liable for any special, incidental, indirect, or consequential damages whatsoever arising out of the use or inability to use the boat or any component part thereof, even if MasterCraft has been advised of the possibility of such damages or such damages could reasonably have been foreseen by MasterCraft.

- (b) **Purchase Price Limitation.** In any event, MasterCraft's entire liability under any provision of this Limited Warranty shall be limited to the repair or replacement of the boat or component part or the refund of the purchase price paid by the customer for the boat or component part found to be defective within the applicable warranty period. This shall constitute MasterCraft's sole liability and obligation in the event of any claim arising out of its performance or non-performance of any provision of this Limited Warranty. Because some states and jurisdictions do not allow the exclusion or limitation of liability, the above limitations may not apply to you.

5. Transfer of Limited Warranty.

Upon any sale, conveyance or other transfer of the boat or trailer by the original retail purchaser, any remaining unexplored Limited Warranty coverage shall be transferred to the second owner and shall remain in effect for the remainder of the applicable warranty period(s) set forth in **Sections 1(b), (c), (d) and (e)** above (which warranty periods begin to run from the date of the original retail purchase of the boat or trailer, as applicable, by the original retail purchaser), upon delivery of the warranty transfer card and payment of the applicable warranty transfer fee to MasterCraft. With respect to the Lifetime Limited Warranty (granted to the original retail purchaser) as the Structural Components set forth in **Section 1(a)** above, if the sale, conveyance or other transfer of the boat by the original retail purchase of the boat by the original retail purchaser, then the warranty on the Structural Components shall



be transferred to the second owner and shall continue in effect for a period of ten (10) years from the date of the original retail purchase of the boat by the original retail purchaser. If the sale, transfer or conveyance of the boat by the original retail purchaser occurs more than three (3) years after the date of the original retail purchase of the boat, then the Limited Warranty on Structural Components (as well as all other warranties) shall be void and shall not be transferable to the second owner.

Only one (1) transfer under the provisions of this Section 5 (from the original retail purchaser to the second owner), within the applicable time period, may be made. In the event of a sale or transfer to a subsequent purchaser, all coverage under this Limited Warranty shall immediately be terminated and the Limited Warranty shall become null and void. No transfer of this Limited Warranty will operate to extend the warranty periods set forth in Section 2 above. In order to effectuate the transfer of the Limited Warranty, the original retail purchaser and the new owner must properly fill out the warranty transfer card found in the back of the Owner's Manual and deliver the completed card, together with a check made payable to "MasterCraft Boat Company, Inc.," in the amount of the warranty transfer fee, via U.S. mail, postage prepaid, to MasterCraft at the address shown on the warranty transfer card. The card and check for the warranty transfer fee must be post-marked within the time period specified above in Section 5

in order for the warranty transfer from the original retail purchaser to the second owner to be effective.

6. Warranty Claims.

Subject to the terms of this Limited Warranty, any covered boat or component part with a material defect in materials or workmanship which is returned to an authorized MasterCraft repair facility or MasterCraft's factory during the appropriate warranty period will be repaired or replaced, at MasterCraft's sole option, without charge to the owner. This provision is subject to the following terms and conditions:

- (a) MasterCraft shall be obligated only to repair or replace those items that prove defective, in MasterCraft's sole discretion, upon examination by MasterCraft's authorized personnel.
- (b) MasterCraft warrants its repairs or replacements only for the remainder of the applicable warranty period.
- (c) MasterCraft shall, in its sole discretion, fulfill its obligation to repair or replace any defective item at its factory or authorized repair facility.
- (d) The owner shall be responsible for all costs associated with the transportation of the boat, towing bills, trailer or part(s) to the authorized MasterCraft facility and for any return transportation.

7. No Modification of Warranty.

No oral or written information, advice or communication of any nature by or from MasterCraft or its representatives, employees, dealers, agents, distributors or suppliers shall create a warranty or in any manner increase or modify the scope of this Limited Warranty.

Limited Power Train Warranty

Indmar Products Company, Inc., administers the Indmar engine warranty on marine propulsion engines sold by it (the "product"):

- A. For a period of thirty-six (36) months commencing from the date of purchase or the date of commencement of the product use, whichever occurs sooner, in the case of non-commercial use.
- B. For a period of three (3) months commencing from the date of purchase or the date of commencement of the product use, whichever occurs sooner, in the case of commercial use.

These are warranted only in the United States—excluding its territories.

A. Persons Applicable

This warranty is extended only to the original retail purchaser, except in instances of a transfer to the second owner only for a fee. Warranties of any nature to any other person are hereby specifically excluded.

B. Implied Warranties

All implied warranties or merchantability and fitness for the particular purpose are specifically limited in duration to the



foregoing periods of this limited warranty. Some states do not allow limitations on how long an implied warranty lasts, so the above limitation may not apply to you.

C. Coverage

The product is warranted to be free from defects in material and workmanship under normal use and service during the period of this Limited Warranty. If the product or defective part thereof is, upon examination, determined to be thus defective, MasterCraft (Indmar) shall repair or, at its option, provide a replacement of equivalent quality (new or rebuilt, at its option).

D. Procedure

For warranty claims to be asserted hereunder, the product or defective part thereof, together with a written notice of itemized defects must be returned to the retailer from whom the product was purchased or to any other convenient Indmar dealer.

To obtain the location of an authorized dealer or service center in your area, write to Indmar requesting such information.

In the event that the local Indmar dealer is unable to remedy a warranty defect in the product, the product or defective part thereof, together with a written notice of itemized defects, must be returned to Indmar with freight and insurance charges pre-paid.

All insurance and freight charges for return by Indmar of the product (or its substitute) to the original retail purchaser shall be paid by the original retail purchaser.

Expenses for labor incurred by Indmar in the repair of any warranted products shall be paid by the original retail purchaser to the extent that such expenses for labor exceed the specified

service rates of Indmar in effect at the date of receipt of the product by Indmar. A schedule of service rates of Indmar may be obtained from any authorized Indmar dealer.

E. Consequential Damages

This warranty shall not extend to consequential or incidental damages or costs incurred by the original retail purchaser. Some states do not allow the exclusion or limitation of incidental or consequential damages, so the above limitation or exclusion may not apply to you.

F. Trade Accessories

No warranty of any character is made with respect to trade accessories not manufactured by Indmar.

G. Voiding Warranty

This warranty is specifically voided and shall NOT apply under the following conditions;

- I. When the product or any part thereof is subjected to accident, alteration, abuse, misuse, neglect or improper maintenance.
- II. When the product is serviced by unauthorized persons.
- III. When damage to the product results from causes not arising out of defects in material or workmanship.

Indmar does not authorize any person, firm or corporation to alter this Limited Warranty or create any other obligation relating to the product. This warranty gives you specific legal rights, and you may also have other rights which vary from state to state.



Recognizing the pride that MasterCraft owners take in their boats, MasterCraft has been diligently working to develop our own line of products designed specifically to ensure a better-looking, longer-lasting product.

Your 2003 model ProStar, X-Series or MariStar boat is just the second full model year to be able to utilize these products. As you maintain your boat over the coming years, use Genuine MasterCraft Parts (GMP) to keep the pride!

MasterCraft Marine Motor Oil

The life of your marine engine is dependent upon proper lubrication. That is why we've developed the MasterCraft Marine Motor Oil. This premium marine motor oil is formulated specifically for MasterCraft Boat Company for use in high performance marine engines. The oil provides high viscosity and film strength for engines protection in high-load applications. You cannot get the same formula in any other engine oil!

MasterCraft oil is designed to protect against corrosion, wear, oxidation, varnish and sludge deposits. When used as directed in the Owner's Operation and Maintenance Manual, this oil assures compliance with MasterCraft warranty requirements. MasterCraft Marine Motor Oil is an exclusive product available only through genuine MasterCraft dealerships!

MasterCraft Premium All-Purpose Cleaner

Most MasterCraft boat owners pay attention to the details, especially when it comes to the maintenance and life of the boat interior. We give you information in the *Operations and Maintenance Manual* on how to extend the life of the boat interiors. We especially caution to avoid certain household cleaners, powdered abrasives, steel wool and industrial cleaners that can cause damage and discoloration. Dry cleaning fluids and lacquer solvents should not be used because they will remove the printed pattern and gloss.

No cleaner can remove every mark or stain, but we provide a table in the manual that tells the owner what to use and how to treat many stains. For regular maintenance, however, we've never told you what to use—only what not to use. Now, with this new product, MasterCraft Premium All-Purpose Cleaner, you can do it right!

A powerful foam cleaner that cuts through grease, dirt and grime, the foam clings to vertical surfaces and penetrates through dirt that accumulates. MasterCraft Premium All-Purpose

Cleaner is an exclusive product available only through genuine MasterCraft dealerships!

MasterCraft Premium Shine & Protectant

After boat owners get the interior surfaces clean, they like to have a product that will help keep everything looking ship-shape. Waxes are not recommended for interior surfaces because many contain dyes or solvents that can permanently damage the protective coating. That's why MasterCraft developed our own Premium Shine & Protectant to guard against ultraviolet rays, environmental conditions and everyday use, while adding years of life and beauty.

This product penetrates, protects and beautifies. It contains no fluocarbons either. MasterCraft Premium Shine & Protectant provides a protective shield that gives a long-lasting appeal for plastic, plexiglass, vinyl, rubber, acrylics, Formica, wood and leather—so it can be used on more than just the boat!

For best results, consumers should leave the Shine & Protectant on surfaces for several hours or overnight before removing excess. This product is available only through genuine MasterCraft dealerships!

MasterCraft Premium Marine Wax

If you take great pride in the appearance of your boat, by using MasterCraft Premium Marine Wax, you help ensure a long-lasting and attractive shine for the deck and hull. This pre-softened formula combines carnuba wax with efficient cleaning agents that remove oxidation, engine exhaust spill-off and other contaminants.

MasterCraft Premium Marine Wax provides a deep gloss with long-lasting protection from UV rays, salt air and harsh weather conditions. It's great for fiberglass, gel coat, aluminum, chrome and painted surfaces.

This product protects and inhibits color fading and cleans effectively without harmful abrasives, leaving a beautiful glossy shine. It protects against harsh weather conditions, too. Using this GMP product will assist boat owners in following the requirements outlined in the *Operations and Maintenance Manual* for providing protection over the life of the boat.

MasterCraft Premium Marine Wax is an exclusive product available only through genuine MasterCraft dealerships!

Talk to your dealer about other MasterCraft products available for your boat. And remember: You bought the best...now keep it that way!



you bought the best...now keep it that way!



The Power To Clean...
Spray & Wash The
MasterCraft
MARINE
Model 130

Premium
All Purpose
Cleaner
GIVIT

WARRANTY REGISTRATION TRANSFER (forward this copy to MasterCraft)

Boat Serial Number _____ Model No. _____
Engine Make _____ Serial No. _____ Trans. Type _____ Serial No. _____

PLEASE PRINT

Previous Owner _____

New Owner's Name _____

Street Address _____

City _____ State _____ Zip Code _____

Home Phone _____ Business Phone _____

Date of Purchase _____ Owner Signature _____

(Must be signed!)

Be sure to enclose payment and a copy of the purchase receipt within 14 days of the sale date.



For first purchase of a specific MasterCraft boat, the original owner will receive a warranty registration card to complete and turn in. You should be aware that under federal law, completion of the warranty card is a requirement and should be completed as follows:

1. Dealer must complete the warranty registration at date of sale.
2. **Dealer must secure buyer's signature!**
3. Dealer provides a copy to the buyer, retains a copy for dealership files and forwards the remaining copy to MasterCraft.
4. Card must be mailed to the manufacturer within three days of the sale.

If the MasterCraft boat is subsequently sold, MasterCraft offers a transferrable warranty to the second owner. In accordance with the MasterCraft Limited Warranty, the remaining warranty against structural defect in the hull and deck will be transferred to the new owner when the following has been accomplished and verified:

- Receipt of the completed form above.
 - Copy of the sales invoice.
 - Payment of \$450 within fourteen (14) days of the sale date.
- Upon verification, the remaining warranty will transfer, retroactive to the sale date.

WARRANTY TRANSFER