

*MasterCraft*

**2022 BOAT  
OWNER'S MANUAL**

# CONGRATULATIONS

On your boating choice! MasterCraft is the recognized world leader for inboard boats today and has been for over fifty years. The quality, innovation, selection and value of MasterCraft boats are unmatched in the industry.

Please take the time to read this Owner's Manual completely, in addition to carefully reviewing any additional information provided in the accompanying packet. These publications will help to answer most of the remaining questions you may have regarding the new boat. If you have any additional questions after reading these publications, please feel free to speak with your dealer. MasterCraft wants you to feel comfortable with your boat (and trailer, where applicable) from the very beginning of your experience as an owner of our products.

All information in this Owner's Manual is based on the latest product information available at the time of printing. Because of our policy of continuous product improvement, we reserve the right to make changes at any time, without notice, in specifications and models, and also to discontinue models. We also reserve the right to change specifications, parts or accessories at any time without incurring any obligation to equip the same on models manufactured before the date of the change. MasterCraft recommends checking [www.mastercraft.com](http://www.mastercraft.com) periodically, specifically the Knowledge Center, for updates and additional information.

Due to changes in specifications, models, parts and/or accessories that may occur after publication of this Owner's Manual, the Owner's Manual may not cover every circumstance that may arise in owning and operating a boat. Also, the illustrations used in this Owner's Manual are intended only as representative reference views and may not depict actual model component parts. Information regarding certain on-board components furnished by suppliers other than MasterCraft, including the engine and power train components, is provided separately by the manufacturers of those components. This information is available through your dealer. A reasonable effort has been made by MasterCraft and its suppliers to provide the applicable information required to ensure a long-lasting and enjoyable boating experience.

# TABLE OF CONTENTS

<b>Safety Knowledge</b> .....	<b>01</b>	<b>Preparation</b> .....	<b>303</b>
Consistent Attention Required .....	07	Ilmor Marine Engines .....	307
Events Requiring Safety Knowledge .....	13	Safety Checks and Services .....	311
Equipment .....	21	New Boat Break-In .....	315
Legal Requirements .....	25	Starting and Basic Operations .....	319
Other Important Information .....	31	Operational Hints .....	323
Rules of the Open Water .....	37		
<b>2022 Model Features and Specs</b> .....	<b>45</b>	<b>Care and Maintenance</b> .....	<b>329</b>
X Series .....	47	Lifting the Boat .....	331
Star Series .....	53	Corrosion Prevention .....	335
XT Series .....	59	Cleaning the Boat .....	339
NXT Series .....	71	Maintenance Service .....	351
		Scheduled Maintenance .....	361
		Storage and Winterization .....	369
<b>Dashes and Video Screens</b> .....	<b>77</b>	<b>The MasterCraft Trailer</b> .....	<b>381</b>
X and XT Series Dual Screen Dash Operation .....	83		
HV550 Passenger Remote .....	117	<b>Limited Warranty Statement</b> .....	<b>431</b>
X and XT Series Engine Gauges .....	125	Warranty Registration and Transfer .....	433
X and XT Series 7" Touchscreen Dash Operation .....	129		
ProStar Video Screen Operations .....	153	<b>Service Log</b> .....	<b>445</b>
NXT Operations .....	171		
NXT20/22/24 Video Screen Operations .....	179	<b>Glossary of Terms</b> .....	<b>451</b>
<b>Boat Operations</b> .....	<b>191</b>	<b>Index</b> .....	<b>455</b>
Basic Electrical Components .....	193		
Additional Safety Support .....	207		
Below Deck .....	215		
Visual Assistance .....	227		
Sport Enhancement .....	233		
Comfort and Convenience .....	261		

**SAFETY  
KNOWLEDGE**



# SAFETY KNOWLEDGE

Prior to operation, be certain that all passengers are aware of where the safety equipment is stowed, the location of emergency equipment such as fire extinguishers and how this equipment is used. In case of emergency, be sure that at least one other person on-board understands how to operate the boat.

Your safety, as well as the safety of others with and around you, is a direct result of how you operate and maintain your boat. You—and anyone who will be operating this boat—should read and seek to fully comprehend this Owner's Manual, and any additional information provided by component manufacturers and suppliers. Make sure that you understand all of the controls and operating instructions before attempting to operate the boat. Improper operation is extremely dangerous!

The basic safety rules are outlined in this section of the Owner's Manual. Additional precautions throughout the Owner's Manual are noted by the following symbols:



**THIS IS THE SAFETY ALERT SYMBOL. IT IS USED TO ALERT YOU TO POTENTIAL PERSONAL INJURY HAZARDS. OBEY ALL SAFETY MESSAGES THAT FOLLOW THIS SYMBOL TO AVOID POSSIBLE INJURY OR DEATH.**

The precautions listed in this Owner's Manual and on the boat are not all-inclusive. If a procedure, method, tool or part is not specifically recommended by MasterCraft, using it may place you and others in an unsafe situation; in addition, you may render your warranty void. Remember: Always use common sense when operating, servicing or repairing the boat!

Observing the safety recommendations found in this Owner's Manual is critical to keeping your boating experience as safe as possible during routine operation. Your failure to do so may result in severe personal injury or death to you and/or others. Use caution and common sense when operating your boat. Do not ever take unnecessary chances!



**DANGER**

**DANGER** indicates an imminently hazardous situation which, if not avoided, will result in death or serious injury.



**WARNING**

**WARNING** indicates a potentially hazardous situation which, if not avoided, could result in death or serious injury.



**CAUTION**

**CAUTION** indicates a potentially hazardous situation which, if not avoided, may result in minor or moderate injury.

**CAUTION**

**CAUTION** used without the safety alert symbol indicates a potentially hazardous situation which, if not avoided, may result in property damage.

# GENERAL PRECAUTIONS

Be certain that all operators of your boat are aware of the safety information within this Owner's Manual and that they use it to conform to boat safety principles.

Boating safety starts with a thorough understanding of boat operations. In addition to careful review of this Owner's Manual, you should also be aware that many sources of helpful information are available. MasterCraft urges you to pursue additional training prior to the independent operation of your boat. Training at any time from a recognized boating and/or safety organizations is beneficial.

The following is a listing of a few agencies and organizations that offer safety training and/or information:

## **AMERICAN RED CROSS, NATIONAL HQ**

2025 E Street, NW  
Washington, DC 20006  
1-800-733-2767  
[www.redcross.org](http://www.redcross.org)

## **U.S.A. WATER SKI ASSOCIATION**

1251 Holy Cow Road  
Polk City FL 33868  
(863) 324-4341  
[www.usawaterski.org](http://www.usawaterski.org)

## **BOAT OWNERS ASSOCIATION OF THE UNITED STATES**

880 South Pickett Street  
Alexandria VA 22304  
(703) 461-2878  
[www.boatus.com](http://www.boatus.com)

## **NATIONAL SAFE BOATING COUNCIL**

9500 Technology Drive Suite 104  
Manassas, VA 20110  
(730) 361-4294  
[www.safeboatingcouncil.org](http://www.safeboatingcouncil.org)

## **U.S. COAST GUARD AUXILIARY**

2703 Martin Luther King Jr. Ave, SE  
Washington, DC 20593-7501  
(202) 267-1001  
[www.uscg.mil](http://www.uscg.mil)  
<http://www.uscgboating.org>



# SAFETY AFLOAT

The cause of many boating accidents is often the operator's failure to follow basic safety rules or written precautions. Many accidents can be avoided if an operator is completely familiar with the boat, its operation, and can recognize potentially hazardous situations before an accident occurs.

## DANGER

**Failure to comply with safety-related information and instructions may result in serious injury or death to you and/or others. Always use common sense when operating the boat or participating in any activities associated with the boat, including, but not limited to, periods of time when the boat engine is shut down and the boat is not in operation.**

- Improper operation of a boat is extremely dangerous! Operators must read and understand all operating manuals supplied with the boat, before operation.
- On-board equipment must always conform to the governing federal, state and local regulations.
- Always attach the engine emergency safety shut-off lanyard to a part of your clothing (such as a belt loop) when operating the boat.

## DANGER

**Never override or modify the engine emergency safety shut-off switch in any way.**

- Never operate the boat, water ski, wakeboard, wakesurf or engage in other water activities while under the influence of alcohol or drugs.
- All persons must be seated in a designated occupant seating area while the boat is in motion. (A seating label is affixed in each model.) Never stand or allow passengers to stand in the boat or sit on the motor box or tower (where equipped), gunwale, decks, or any location other than occupant seating while underway. You or others may be thrown within or from the boat, which could result in serious injury or death. Never allow occupants to use sun pads or transom seating while the engine is running. On models equipped with sliding or adjustable seat backs, ensure that the backs are in the locked position prior to operating the boat.
- Prior to starting the engine, open the engine box and check the engine compartment and bilge for gasoline and oil vapors. Always operate the blower for at least four (4) minutes before starting the boat. Failure to do so may result in fire and/or an explosion.

 **DANGER**

**Failure to comply with the requirement of operating the blower for at least four (4) minutes before starting the engine may result in serious injury or death to you and/or others.**

- Never remove or modify any components of the fuel system. Removal or modification of any component of the fuel system may cause a hazardous situation and will void the warranty. The modern MasterCraft fuel delivery lines are pressurized and attempting to loosen or remove them may result in the uncontrolled release of fuel, which can be environmentally hazardous, and can cause injury.
- Never allow any type of spark or open flame on board. It may result in fire or explosion.

## COMMON SENSE ADVICE

Avoid any activity that may result in damage to the boat, thereby voiding the warranty. Some things, such as avoiding stationary objects, are obvious. However, even less obvious activities can cause damage to a boat, no matter how well-built. For example, while a beach or shoreline may seem soft while walking on it, running a boat up onto shore may result in significant scratches in the gel coat and fiberglass finish. The causes of many kinds of

damage are usually quite obvious to trained service personnel, and if they determine that damage was caused by misuse or activity such as “beaching,” such results can void the warranty.

MasterCraft cannot anticipate every type of activity or neglect that could result in damage to the boat or that may cause illness, injury or even death to boaters. The operator, owner and/or all persons on board are responsible for using common sense and a careful thought process to ensure that every measure has been taken to keep boating enjoyable for many years to come. A MasterCraft boat can be the source of countless hours of family fun, as well as building friendships, but the boating experience remains safe only if you, and everyone on board, use your head before, during and after your boating activity.

As you anticipate many good times ahead with your MasterCraft boat, be sure that first and foremost, you are well-prepared to be responsible.

 **WARNING**

**For most activities the boat operator should be seated at the helm position. Some situations may require standing at the helm to maintain visibility over the bow. When standing is necessary make certain that the safety shut off lanyard is attached to your clothing or PFD. Operating the boat while standing may result in a loss of control which could cause serious injury or death.**

# HAZARDOUS OPERATIONS

There are a number of situations which can result in peril for boats and persons on board. Among these is boating too close to dam spillways, where turbulence and strong currents can result in loss of control of the vessel. These areas as well as other hazardous areas are usually marked. DO NOT ignore such markers.

Additionally, there may be potentially hazardous situations that can adversely affect boating. These include weather conditions (addressed later in this chapter), operating in shallow water where underwater navigational gear may be damaged, or boating in bodies of water that include weeds and other growth that can foul boat operations. These flora can foul your boat engine, restrict water intake to the engine (causing overheating), and restrict the propeller(s) to such an extent that it causes a vibration that can damage the engine and drive train.

# OPERATOR'S RESPONSIBILITIES

**The following are the operator's responsibility:**

- Ensure the boat is in top operating condition and there are no hazards that impede your moving about the boat.
- File a float plan, as described below, with a relative or friend.
- Ensure the bilge is clean prior to starting.
- Have a complete knowledge of the operation and handling characteristics of your boat.
- Ensure that the boat is not loaded above the maximum capacity and that the load is properly distributed. Reference the seating chart label affixed in the boat for proper distribution of persons aboard.
- Ensure that all occupants are seated in designated safe seating. Refer to the seating chart label.
- Ensure that all children onboard are under the direct supervision of a specific adult occupant.
- Learn to navigate your local waterways. Be familiar with your starting and ending locations as well as any waterways along the way.
- Maintain a safe speed at all times to avoid collisions.
- Keep an eye out for changing weather conditions and respond accordingly.
- Know and practice the navigational rules. Know and obey all federal and state regulations and operate the boat properly around all waterway markers.
- Maintain a clear, unobstructed view at all times, especially forward. Scan the water and avoid tunnel vision. Many boating collisions are caused by inattention.

**CONSISTENT  
ATTENTION  
REQUIRED**

# CARBON MONOXIDE (CO)

When anchoring the boat, you **MUST** turn **OFF** the engine. In most models, exhaust fumes containing carbon monoxide are emitted from the exhaust flap area of the transom immediately below the swim platform. No one should ever be on the swim platform or transom while the engine is operating.



**DANGER**

**Carbon monoxide is a colorless, tasteless, odorless and poisonous gas that accumulates rapidly and can cause serious injury or death. Exposure to carbon monoxide can be fatal in a matter of minutes. Exposure to even low concentrations of carbon monoxide must not be ignored because the effects of long term carbon monoxide exposure can build up and be just as lethal as high concentrations. Carbon monoxide from exhaust pipes of inboard or outboard engines may build up inside and outside the boat in areas near exhaust vents, particularly during slow-speed operations. STAY AWAY from these exhaust vent areas, which are located at the stern of the boat, and DO NOT swim or engage in any water sports**

or other activities in or near the stern area of the boat, including, without limitation, the swim platform, the rear sun deck, and aft facing lounge seats when the engine is in operation. Under no circumstances should the owner and/or operator allow persons to hold onto the swim platform while the engine is operating and the boat is in motion. These activities (sometimes known as “teak surfing” or “platform dragging,” where the participant holds onto the swim platform and is pulled through the water, and/or “body surfs” immediately behind the boat) are extremely dangerous, highly likely to result in death or serious bodily injury, and are a misuse of this product.

Carbon monoxide (CO) enters your bloodstream through the lungs, blocking the oxygen your body needs. Prolonged exposure to low concentrations or very quick exposure to high concentrations can be deadly to all on board.

Early symptoms of CO poisoning include irritated eyes, headache, nausea, weakness and dizziness. These can be confused with seasickness or intoxication. Altitude, certain health-related problems, and age will increase the effects of CO. Persons who smoke or are exposed to high concentrations of cigarette smoke, consume alcohol, or have lung disorders or heart problems are particularly susceptible to an increase in the effects of CO. However, anyone can be affected. Another factor to consider is that physical exertion accelerates the rate at which the blood absorbs CO.

# EMERGENCY TREATMENT FOR CO POISONING

CO poisoning or toxicity is a life-threatening emergency that requires immediate action. The following is a list of things that should be done if CO poisoning is suspected. Proceed with caution. The victim may be in an area of CO concentration, which means you or others could be in danger from exposure to CO:

- Evaluate the situation and ventilate the area if possible.
- Evacuate the area and move the affected person(s) to a fresh air environment.
- Observe the victim(s).
- Administer oxygen, if available.
- Contact medical help. If the victim is not breathing, perform rescue breathing or approved cardiopulmonary resuscitation (CPR) as appropriate until medical help arrives. Prompt action can mean the difference between life and death.
- Shut off potential sources of CO, if possible. Correct ventilation problems and/or repair exhaust problems as appropriate. Investigate the source of CO and take corrective action, such as evacuating and ventilating the area or shutting off the source of the CO.

# WHERE CO MAY ACCUMULATE

Carbon monoxide can accumulate anywhere in or around your boat. This includes, but is not limited to:

- Inadequately ventilated canvas enclosures.
- Exhaust gas trapped in enclosed places.
- Blocked exhaust outlets.
- Another vessel's exhaust. CO from the boat docked next to you can be just as deadly as that emitted from your own boat.
- Back drafting from your own boat's exhaust.
- At slow speeds, while idling or stopped. Be aware that CO can remain in or around your boat at dangerous levels even if your engine or the other boat's engine is no longer running.

# HOW TO PROTECT YOURSELF AND OTHERS

Follow these simple steps to help keep CO from poisoning you, your passengers and others nearby:

- Know where and how CO may accumulate in and around your boat. This is particularly important when starting or running engines in boathouses, or near a sea wall. Boats that are moored in close proximity are also potential problems as the fumes from your boat or another boat can affect air drafts on all boats. Back drafting sometimes called the “station wagon effect” occurs when the fumes curl up over the swim platform and transom and into the boat, especially when canvas or other coverings trap the fumes. Even in open air, consider wind direction, the boat’s speed and trim angles.
- Maintain fresh air circulation throughout the boat at all times. CO concentration is greater when the engine is cold. Ensure the boat is situated to take advantage of maximum dissipation of fumes.
- If your boat is equipped with a generator, know where the exhaust outlet(s) is located and keep everyone away from the area.
- Ensure that appliance, air conditioning, heater, generator, or other on-board function that emits fumes is routinely and regularly provided with maintenance as described by manufacturers. Failure to do so can result in the accumulation of CO fumes.
- Never sit, teak surf, or hang on the back deck or swim platform while the engine is running. Teak surfing is NEVER a safe activity.
- Never allow person in the water to swim under the swim platform or transom at any times.
- Operation of boats at mile-high (5,250 ft.) or higher altitudes may affect CO production. Check with an authorized MasterCraft dealer before operating at higher altitudes to determine whether the engine may require additional tuning to prevent excessive CO.
- Although CO can be present without the smell of exhaust fumes, if you smell exhaust fumes, CO is also present. Take immediate action to dissipate these fumes.
- Treat symptoms of seasickness as possible CO poisoning. Get the person(s) into fresh air immediately. Seek medical attention.
- Install and maintain CO alarms inside your boat. Do not ignore any alarm. Replace alarms as recommended by the manufacturer.
- Follow Coast Guard safety checklists.
- Get a Vessel Safety Check. They are free! Your local U.S. Coast Guard Auxiliary can provide details or check [www.uscgaux.org](http://www.uscgaux.org) online to locate assistance.

# WEIGHT LIMITS AND DISTRIBUTION

## **WARNING**

**All boats have weight limits. Failure to adhere to the posted limits can cause operation instability and/or the boat to sink. This may result in serious injury or death, as well as significant damage to the boat, which will not be covered by warranty.**

Overloading a boat may cause it to become unstable and may potentially result in the boat's flotation system becoming overwhelmed. Too much weight can sink any boat. Within this Owner's Manual and on a label mounted in each boat is the Maximum Capacity for that specific model. Bear in mind that maximum limits include additional water ballast bags and water put in them, gear brought onto the boat, additional options and all people. Maximum people is limited to the number of designated occupant seating positions. Equally critical is how weight is distributed throughout the boat. The weight must be distributed evenly throughout the boat. If too much weight is placed in one area it can have serious impact on maintaining control. Items and people can also shift positions during operation, potentially causing a dangerous situation.

Adding weight of any type to the boat will affect the handling characteristics of the boat while it is underway. Caution should always be exhibited when putting the boat into motion or attempting to stop it, particularly when the added-weight characteristics have changed.

## LINE OF SIGHT

Care should also be taken to avoid interfering with the boat operator's line of sight when the boat is underway. This applies particularly to individuals riding in the bow. It is possible to quite unintentionally obscure the driver's view. Even momentary interference can result in the driver's inability to respond to a situation that requires avoidance of another vessel or submerged or partially-submerged objects. MasterCraft recommends using the driver seat bolster or standing to maintain a safe lookout and proper visibility when necessary. Everyone on board should always pay attention to other vessels, people and objects located in close proximity to the boat, activities taking place in or near the water, and should always be supportive of the boat operator.

The law requires the boat operator to maintain clear visibility at all times and in all directions when the boat is in motion.



# PERSONAL FLOTATION DEVICES (PFDs) AND ACCESSIBILITY

Federal law requires at least one wearable Type I, II, III or Type V Personal Flotation Device (“PFD”) for each person on-board or being towed on water skis, wakeboards, surfboards or other recreational equipment. A Type V PFD provides performance of either a Type I, II or III PFD (as marked on its label) and must be used according to the label requirements. In addition, one throwable Type IV PFD must also be on board. As the owner, obtaining the appropriate PFDs is your responsibility. You must also determine whether people on-board, including those who are underage, are required to wear PFDs when underway. Your MasterCraft dealer can, and will be happy to, assist you with your purchase of appropriate PFDs.

People on-board who cannot swim or who are not strong swimmers, as well as children, should wear PFDs at all times.

- Wearable PFDs must be readily accessible in the boat.
- It should be possible to put on the PFDs within a reasonable amount of time in case of emergency.
- PFDs should never be stowed in plastic bags, in locked or closed compartments or have other gear stowed on top of them.

- The U.S. Coast Guard, as well as MasterCraft, recommends the wearing of PFDs at all times when the vessel is underway, even though it is not a requirement. The best PFD is the one that is worn and that can save your life.
- Inflatable PFDs must have a full cylinder and all status indicators on the inflator must be green, or the device is NOT serviceable, and is NOT considered a usable PFD for anyone on-board the vessel.
- Coast Guard-approved inflatable PFDs are authorized for use on recreational boats by persons at least 16 years of age.
- Some states require children to wear PFDs at all times. Check with your state boating safety officials for details. Be certain to equip children with a PFD that is appropriate for the size of the child. The label will indicate the weight limits for use.

**NOTE: Requirements for coastal waters and inland waters differ. Check with the local boating authorities for more information.**

**EVENTS  
REQUIRING SAFETY  
KNOWLEDGE**

# IN THE EVENT OF A FIRE

Fire on-board is among the most serious of matters that boaters can experience. Due to the close proximity of fuel tanks and a number of electrically operated items that can result in a spark or arc, any and all fires on a boat should be a matter for immediate action.

While your MasterCraft boat is equipped with a fire suppression system and fire extinguishers (except models imported into Japan), it is important to make a quick and calculated decision regarding any fires. If the extinguishing/suppression materials do not quickly extinguish the fire, it may become necessary to abandon ship. Make sure everyone on board has a PFD and swims as quickly and as far as possible, up wind and upstream from the boat. If gasoline is released, it will float on top of the water. It may spread out or move with the body of water's current.

## FIRE EXTINGUISHERS

The engine compartment in every MasterCraft boat is equipped with an automatic fire suppression system. The system has a manual deployment handle mounted in the helm area (domestic boats only) which uses a clean agent canister to suppress fires in the engine compartment.

Every boat MasterCraft builds is required by law to have on board one (1) 2.5-pound, dry chemical fire extinguisher rated for Type A, B

and C fires. The dry chemical fire extinguisher is standard equipment, and is automatically included in your boat from the factory. Replacement units can be ordered from MasterCraft.

If any of the fire suppression system canisters on board your boat are discharged (whether a canister in an automatic system or a portable fire extinguisher), then they must be replaced immediately. If the automatic fire suppression system has been discharged, the video display at the helm will notify the driver. If the clean agent canister associated with the automatic fire suppression system has been discharged, it must be replaced. Contact your authorized MasterCraft dealer to obtain a replacement for the clean agent type of canister. If the dry chemical fire extinguisher has been discharged, it must be replaced with a fire extinguisher that is rated for Type A, B and C fires from an authorized MasterCraft dealer or another source.



Fire extinguishers require periodic maintenance. Monthly, each fire extinguisher on your boat should be examined to be sure that the seals and tamper indicators are not broken or missing. The pres-

sure gauges or indicators, if applicable, should read in the operable range. There should be no obvious physical damage, rust, corrosion, leakage or clogged nozzles. Additionally, if the extinguisher has not been used, it should be weighed annually to assure that the minimum weight as stated on the label still exists. Any fire extinguisher that has been partially emptied must be replaced as soon as possible.

In an automatic/manual system, ensure the pin inserted to protect the system at the helm during transit from the factory (pictured above) has been pulled to activate the system. This is part of dealer preparation, but it is the responsibility of the boat owner to ensure that the system is functional.

## FIRE SUPPRESSION AND EXTINGUISHING

All MasterCraft boats are equipped with an automatic fire suppression system. The automatic system operates from sensors in the engine room and will automatically release a clean-agent, gaseous chemical that does not leave residue behind.

It is also possible to activate the system manually on the domestic boats only. Pull the pin with the red tag (pictured to left), and then pull the red fire handle to set the system in operation. (International boats are automatic only.)

In case of an engine compartment fire, shut down the engine and

blowers before manual discharge, or immediately following the automatic discharge. Boats are equipped with a discharge indication light at the instrument panel or on the video display gauge at the helm.

After the suppression system has been used, the fire extinguisher canister will be empty. The boat owner/operator should have the canister replaced as soon as possible.

MasterCraft boats have also been specified to carry a hand-held 2.5 lb. monoammonium phosphate expellant (dry chemical) unit, which is rated Class A (trash, wood and paper), Class B (flammable liquids, fuel, gas) and Class C (energized electrical equipment). These units should be used in situations other than engine compartment fires.

Hand-held units should be replaced or recharged as soon as possible after use. Chemical discharge should be cleaned from all surfaces as soon as possible and prior to running the boat again, unless operation is necessary to return to shore.

The boat should never be operated following a fire until after a determination has been made whether operation may result in another fire. If any danger of an additional fire exists, the boat should be towed to shore or dock rather than running the engine(s).

Consumers who choose to purchase fire control equipment from resources other than MasterCraft must follow the instructions and requirements as listed within the engine compartment regarding suitability for the compartment volume. These standards are established by the Coast Guard Code of Federal Regulations (CFR) and the American Boat and Yacht Council (ABYC).



## DANGER

Following the activation of the automatic fire suppression system or a hand-held fire extinguisher, a careful determination should be made as to whether the boat can safely be operated. If there is any doubt or concern whatsoever, the boat should be towed to shore and/or dock for service by an authorized MasterCraft dealer prior to operating again. Failure to follow these instructions could result in death or serious injury/illness.

## CAPSIZING

In addition to fire, a boater's greatest concern may be with the possibility of capsizing or overturning the boat. A number of factors can occur that will result in a boat overturning (high waves, excessive wakes, bad weather) or sinking as a result of damage such as striking an underwater object or another boat. In the event of such an occurrence, try to turn the engine OFF.

Attempt to locate any other people who were on-board and determine whether they are injured. Unless there is fire or release of gasoline, in most instances it is wise to remain with the boat. Climbing on the hull will make it easier for rescuers to locate you and others.

## MEANS OF RE-BOARDING

There are several ways to re-board a MasterCraft boat from the water. In some models, ladders are offered to assist in re-boarding. On some models, re-boarding ladders may be mounted to the swim platform. To re-board using a ladder, deploy the ladder and use it to climb up into the boat or onto the swim platform. Always maintain three points of contact with the boat when using a ladder to re-board the boat. For instructions on deploying a ladder, refer to the Ladders section of this Owner's Manual.

In some models, ladders are an option or may not be available. To re-board a boat without an optional ladder, move to the swim platform on the transom. Place both hands, palms down, onto the top of the platform. Using your legs to kick swiftly upwards, pull your body and legs up over the edge of the platform. Additional leverage may be gained by using the grab handles integrated into the swim platform. Lean into the platform and swing one leg up onto the platform. Use the grab handles to provide support while pulling the rest of your body onto the platform. Stand up, maintaining three points of contact with the boat, and use the transom step to climb back into the cockpit of the boat.



## CAUTION

**Do not allow arms, legs, or body to extend below the swim platform or transom. Metal surfaces mounted on the hull may cause minor to moderate injuries.**

# RUNNING AGROUND OR STRIKING UNDERWATER OBJECTS

Ascertain whether there is damage to the hull. If water can be stopped from entering the boat, cautiously return to dock. Have the boat checked out by your authorized MasterCraft dealer to be certain that the hull has not been weakened. Even if water does not intrude initially, difficulties may occur later.

If water is entering the boat after running aground or striking an underwater object, call or signal for assistance. Abandon ship, if necessary. Do not attempt to out-run a significant leak, as it can be difficult to estimate how long it will take for enough water to intrude and sink the boat.

# IN-WATER ACTIVITIES SAFETY

Individuals in the water are obligated to be as aware of the fundamental safety rules as operators. If you are new to water sports, you should seek certified training before starting. You may find it especially helpful to join a local water-sports club, if available, and the U.S.W.S.A. (United States Water Skiing Association).

Remember that the majority of in-water injuries are the result of impacts with other objects, so always look where you are going, and be aware of what is going on around you.



## DANGER

**PROPELLER(S) MAY CAUSE SERIOUS INJURY OR DEATH.**

**Shut off the engine(s) when near persons in the water, prior to using sunpads, the swim platform or the boarding ladder.**

- Never put your arm, head or any other part of your body through the handle/bridle of the ski or wakeboarding line. Never wrap the line around any part of the body at any time.
- Never ski, wakeboard, wake surf or engage in tubing at night.
- Never ski, wakeboard, wake surf or engage in tubing directly in front of other boats.
- Never follow another boat pulling a rider or tuber. The person may fall and could make it necessary to take immediate evasive measures. This is an unsafe form of operation that should be avoided.
- When adding accessories to the tower, ensure that the total aggregate weight of the accessories does not exceed 85 lbs. (U.S.). Exceeding the limit may result in structural failure of the tower. MasterCraft strongly encourages the use of MasterCraft towers and accessories only as they have been tested and determined to meet product requirements, including weight.



## WARNING

**Towers should never have a total aggregate weight of accessories exceeding 85 lbs. (U.S.). Excessive weight can cause tower failure and the collapse of a tower or the disconnection of the tower from**

**the deck, which could result in serious bodily injury or damage to the boat that is not covered by warranty.**

- Never jump from a boat that is moving at any speed, nor enter or exit the water when the engine is running (ON). (See the Common Sense Approach section of this Owner's Manual for additional information regarding carbon monoxide peril.)



**DANGER**

**Maintain a distance of at least six (6) feet from the ski platform when wake surfing or tubing. Any closer risks exposure to CO fumes, which can be deadly. Never launch a surfboard from the ski platform (or any part of the boat) or end a surfing session by surfing onto the ski platform. Such activities can damage the boat, which is not covered under warranty. Being on the ski platform at any time the boat is running can potentially expose individuals to CO poisoning as well.**

- Never ride on the ski platform or hold on to the ski platform while in the water during engine operation, including at idle. Carbon monoxide fumes are expelled from the lower transom areas of your boat and can cause death or serious illness. See the Common Sense Approach section following for more details.
- Never climb, sit or stand on a tower. The tower is intended for towing only as noted.
- Make sure that everyone knows and uses approved skiing/wakeboarding hand signals and adheres to common skiing, wakeboarding and boating courtesy. Inexperienced skiers might not know that there are waterskiing hand signals, similar to bicycle

and motorcycle hand signals, that can be used while skiing. For example, giving a thumbs up or palm facing up signal while motioning upwards means “speed up,” and the opposite, thumbs down or palms facing down, means “slow down.” There are also signals for speed—turn right, turn left, stop—and signals for when you are down in the water. Learning these help the water skier communicate with the boat over the loud roar of the engine. The best way to utilize these signals is by having a spotter. Many states require at least two people be aboard the boat while towing a skier—one driver and one spotter. Having a spotter to watch the water skier allows the driver of the boat to concentrate on the water in front of and around the boat. The spotter watches the water skier and communicates hand signals to the driver and also can alert the driver when the skier falls.

- Give immediate assistance to anyone who falls because they are vulnerable and may not be seen by other boaters. Approach individuals in the water from the leeward side (opposite the wind) and turn OFF the engine prior to reaching them. Propellers and engine exhaust are only part of the potential problem for someone in the water. Be aware that propellers may continue to turn for a period of time after the engine is shut OFF, and the edges are often sharp enough to easily cut skin or break bones.
- Ski and wakeboard only in acceptable areas. Avoid restricted areas.
- The above mandates are not all-inclusive. It is the boater's responsibility to operate the boat in a safe fashion and become familiar with any and all rules and regulations governing boat operation.



## **DANGER**

Do not tow more than two (2) persons at one time on a tow tower. The tow tower approved for use on your boat should be used only for water skis, wakeboards, surfboards or recreational two-person towables, and not for parasailing, kite flying or towing other boats. Do not add any attachments that are not approved for use on your MasterCraft boat. Do not climb on, sit on, stand on, jump off of or dive off of the tower. Never allow passengers to sit behind the tow rope attachment point. Never allow loose tow rope ends to dangle. Always be certain that all bolts are in place and tight before and during use. When the tower is up, watch for low obstacles such as tree limbs, bridges or power lines.





MasterCraft

**EQUIPMENT**

# SAFETY EQUIPMENT

Federal law requires certain safety equipment to be on-board your boat at all times. Responsible boaters carry additional equipment in case of emergency. It is your responsibility to check with the local boating authorities for any additional requirements and/or equipment over and above the federal requirements.

# REQUIRED EQUIPMENT

Your MasterCraft boat was equipped at the factory with most of the federally required safety equipment for inland waters (Class II, 26-foot-to-40-foot watercraft). This equipment includes:

- ABYC-approved (American Boat & Yacht Club) marine mufflers with water injection
- USCG-approved (United States Coast Guard) marine flame arrestor
- USCG-approved engine box ventilation with spark-less blower
- ABYC-approved electric horn sound-warning device
- USCG-approved inland lighting
- Automatic and manual fire extinguishers

# RECOMMENDED EQUIPMENT

The responsible boat owner will avoid potential problems on an outing by having additional equipment on board. Normally, the decision regarding the appropriate equipment to take on individual outings is dependent upon the body of water and the length of the trip. We suggest the following equipment as a minimum (your MasterCraft dealer can also assist you with additional recommendations):

- Anchor with at least 75 feet of line (in saltwater operation, particularly)
- Manual bailing device for removing water
- Combination oar/boat hook
- Day-and-night visual distress signal
- First aid kit and manual
- Airway breathing tube
- Waterproof flashlight
- Non-electric horn or whistle
- Set of local navigational charts
- Mooring lines and fenders
- Extra engine oil
- Tool kit
- Portable, battery-operated AM/FM radio or weather radio/scanner

# SOUND PRODUCING DEVICES

Navigation rules require sound signals to be made under certain circumstances. Meeting, crossing and overtaking situations, which will be described in some detail shortly, are examples of when sound signals are required. Recreational vessels are also required to use sound signals during periods of reduced visibility. Your MasterCraft boat is equipped with a horn, but you may also purchase after-market devices in case of potential electrical disconnect or failure.

The following are standard signals when using a whistle:

- One prolonged blast: WARNING.
- One short blast: PASS ON MY PORT SIDE.
- Two short blasts: PASS ON MY STARBOARD SIDE.
- Three short blasts: MY ENGINES ARE IN REVERSE.
- Five or more blasts: DANGER!

**NOTE: The requirement to carry a bell on board no longer applies to vessels operating on International Waters.**

# VISUAL DISTRESS SIGNALS

All vessels used on coastal waters, the Great Lakes, territorial seas and those waters connected directly to them up to a point where

a body of water is greater than two miles wide, must be equipped with U.S.C.G.-approved visual distress signals. Vessels owned in the United States but operating on the high seas must be equipped with U.S.C.G.-approved visual distress signals.

Pyrotechnic visual distress signals must be Coast Guard-approved, in serviceable condition and readily accessible. This means that:

- They are marked with an expiration date. Expired signals may be carried as extra equipment, but cannot be counted toward meeting the visual distress signal requirement, since they may be unreliable.
- If pyrotechnic devices are selected, a minimum of three are required. That is, three signals for day use and three signals for night. Some pyrotechnic signals meet both day and night use requirements.
- Pyrotechnic devices should be stored in a cool, dry location, if possible. A watertight container painted red or orange and prominently marked “Distress Signals” or “Flares” is recommended.

U.S.C.G.-approved pyrotechnic visual distress signals and associated devices include pyrotechnic red flares, hand-held or aerial; pyrotechnic orange smoke, hand-held or floating, or launchers for aerial red meteors or parachute flares.

Non-pyrotechnic devices may be allowed. These include an orange distress flag (day signal only) or an electric distress light (which is acceptable for night use). Use of these devices must still meet Coast Guard requirements, information for which is available online and from the Coast Guard.

Under Inland Navigation Rules, a high intensity white light flashing at regular intervals from 50-70 times per minute is considered a distress signal. Such devices do NOT count toward meeting the visual distress signal requirement, however. Regulations prohibit display of visual distress signals on the water under any circumstances except when assistance is required to prevent immediate or potential danger to persons on board a vessel.

All distress signals have distinct advantages. No single device is ideal under all conditions or suitable for all purposes. Pyrotechnics are universally recognized as excellent distress signals. However, there is potential for injury and property damage if not properly handled. Particular care should be used in stowage of pyrotechnics if children will be on board. These devices produce a very hot flame and the residue can cause burns and ignite flammable materials.

**Check with local authorities regarding the best visual distress signal for use in the area in which you will be boating.**

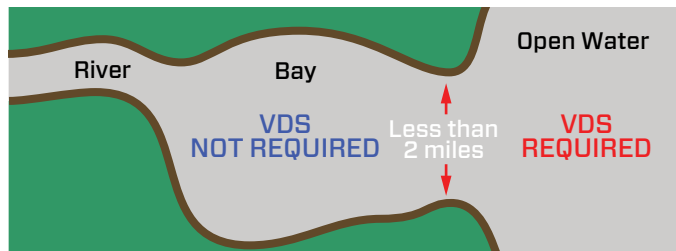

## NAVIGATIONAL LIGHTS

Your MasterCraft boat is equipped with navigational lights. See the Guide to Individual Models section to determine the location of the navigational lights on your boat or verify with your dealer.

Anytime you are moving on the water between sunset and sunrise, you are required to have your navigational lights operating.

**Note: The ProStar Navigation Light should only be used in inland waterways and is not classified as an offshore navigation light.**



## WARNING PLATES AND LABELS

Read and note ALL warning plates and labels from bow to stern, including those that are installed inside the engine compartment, lockers and under seating.

**YOU MUST READ AND ADHERE TO ALL CAUTIONS AND WARNINGS IN AND ON YOUR BOAT!**

# LEGAL REQUIREMENTS

# LAW ENFORCEMENT

A vessel underway, when hailed by a Coast Guard vessel, is required to heave to, or maneuver in such a manner that permits a boarding officer to come aboard.

Other federal, state and local law enforcement officials may board and examine a vessel. The Coast Guard may impose a civil penalty up to \$1,000 for failure to comply with equipment requirements; failure to report a boating accident; or comply with other federal regulations. Failure to comply with the Inland Navigation Rules Act of 1980 can result in a civil penalty up to \$5,000. Details of the Act are available online or through the U.S. Coast Guard and the Coast Guard Auxiliary.

# OPERATOR'S LICENSE

Some states are implementing operator's license requirements. These requirements vary widely. Many states now have restrictions regarding age. If you are operating in a location where minors are allowed to operate the boat, careful supervision by an adult should be the rule of thumb always. Whether operating a boat locally or in a remote location, operators should annually verify with state and local authorities regarding whether a license or training is required.

# BOATING UNDER THE INFLUENCE

**Boating under the influence of alcohol or drugs can be as deadly as driving a car while under the influence!**

Did you know:

- A boat operator is likely to become impaired more quickly than a vehicle driver, drink for drink?
- The penalties for BUI can include large fines, revocation of operator privileges and serious jail time?
- The use of alcohol is involved in about one-third of all recreational boating fatalities?

It is illegal to operate a boat while under the influence of alcohol or drugs in every state. The Coast Guard also enforces a federal law that prohibits BUI.

Alcohol affects judgment, vision, balance and coordination. These impairments increase the likelihood of accidents afloat for both boat operators and passengers. U.S. Coast Guard data shows that in boating deaths involving alcohol use, over half the victims capsize their boats and/or fell overboard.

Alcohol is even more hazardous on the water than on land. The marine environment of motion, vibration, engine noise, sun, wind and spray accelerate a drinker's impairment. These stressors cause fatigue that makes a boat operator's coordination, judgment and reaction time decline even faster when using alcohol.

As a result of alcohol's effects, a boat operator with a blood alcohol concentration of approximately .10 percent is estimated to be more than 10 times as likely to die in a boating accident than an operator with zero blood alcohol concentration. Passengers are also at greatly increased risk for injury or death, especially if they are also using alcohol.

The Coast Guard and every state has stringent penalties for violating BUI laws. Penalties can include fines, suspension or revocation of boat operator privileges, and jail time. The Coast Guard and individual states cooperate fully in enforcement of BUI laws in order to remove impaired boat operators from the waters.

In waters that are overseen solely by the states, the states have the authority to enforce their own BUI statutes. In state waters that are also subject to U.S. jurisdiction, there is concurrent jurisdiction. That means if a boater is apprehended under Federal law in these waters, the Coast Guard will (unless precluded by state law) request that state law enforcement officers take the intoxicated boater into custody. Depending on the circumstances, the operator may be arrested. Penalties vary, but in many jurisdictions operators found guilty of BUI can expect a civil penalty of at least \$1,000 or criminal penalty of \$5,000, one year of imprisonment or both. Civil lawsuits in cases of property damage or injury/death to others can result in significantly more serious penalties.

Intoxication from drugs, including legal prescription drugs, is an equally serious matter and is dealt with as seriously as alcohol.

# REGISTRATION, NUMBERING AND DOCUMENTATION

Although it might not be immediately obvious as to how this relates to boating safety, it can in fact be critical in emergencies. All undocumented vessels equipped with propulsion machinery must be registered in the state of principal use. A certificate of number will be issued upon registering the vessel. These numbers must be displayed on your vessel. The owner/operator of the vessel must carry a valid certificate of number whenever the vessel is in use. When moving to a new state of principal use, the certificate is valid for 60 days. Check with your state boating authority for registration requirements.

Numbers must be painted or permanently attached to each side of the forward half of the vessel. The validation stickers must be affixed within six inches of the registration number. With the exception of the vessel fee decal, no other letters or numbers may be displayed nearby. Lettering must be in plain, vertical block characters of no less than three (3) inches in height. Spaces or hyphens between letter and number groupings must be equal to the width of a letter other than "i" or a number other than "1."

The owner of a vessel must notify the agency which issued the certificate of number within fifteen (15) days if the vessel is transferred, destroyed, abandoned, lost, stolen, or recovered; if the certificate of number is lost/destroyed; or if the owner's address



has changed. If the certificate of number becomes invalid for any reason, it must be surrendered in the manner prescribed to the issuing authority within 15 days.

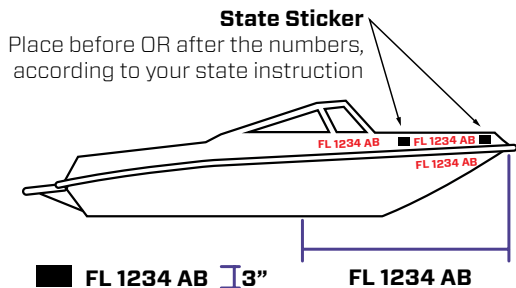

## ACCIDENT REPORTING

Federal law requires the boat operator to file a boating accident report with the state reporting authority when, as a result of an occurrence that involves a boat or its equipment:

- A person dies
- A person disappears from the vessel under circumstances that indicate death or injury
- A person is injured and requires medical treatment beyond first aid
- Damage to vessels and other property totals \$2,000 or more

(the amount may be lower in some states and territories; verify with local boating authorities)

- The boat is destroyed

If the boat operator is deceased or unable to make the report, the boat owner is required to file the report.

Your responsibility does not end with your own craft. You are required by law to respond to any distress signal, visual or auditory. Render immediate assistance, EXCEPT in instances in which you and your passengers will be endangered or those situations that exceed your capabilities or the capabilities of your boat. Good Samaritan protection is provided to boaters who provide good faith assistance and protects them from civil liability for assistance given.

## SPEEDING AND NOISE

Some states and boating areas have imposed speed limits for operation of boats, including but not limited to no-wake zones. Noise regulations may also be imposed. It is the responsibility of the boat operator to be familiar with any and all laws and regulations and to obey them. The U.S. Coast Guard is an excellent source for this information, including penalties for failure to observe the requirements.

# RADIOS—TELEPHONES

Improper use of a radio-telephone is a criminal offense. The use of obscene, indecent or profane language during radio communications is punishable by a \$10,000 fine, imprisonment for two years or both. Other penalties exist for misuse of a radio, such as improper use of Channel 16 VHF-FM, a calling and distress channel. It is not to be used for conversation or radio checks. Such communications should be conducted on an authorized channel.

# REFUSE AND POLLUTION

There are stringent requirements regarding pollution, discharge of oil, discharge of garbage and the operation and discharge from sanitation devices. It is the boat owner's and operator's responsibility to determine laws and regulations and to ensure that those laws and regulations are respected and enforced.

Details are available through the U.S. Coast Guard.

The preceding information provides requirements within the United States territorial waters. Boats operated under other autonomous governmental agencies throughout the world will have their own legal requirements, including the international MARPOL Treaty.

Boat owners and operators are responsible for determining what those requirements are and complying with them, regardless of the owner/operator's citizenship.

This Owner's Manual was developed to help ensure an enjoyable boating experience with a your MasterCraft boat. As stated earlier, this information is not all-inclusive. There are many factors to consider and additional information that you need to research before undertaking any boating activity.

In addition to reading this Owner's Manual and other related material, and familiarizing yourself with the proper operation of the MasterCraft boat, always use common sense when boating.

# BOAT SAFETY LABELS

Warning labels are placed on your MasterCraft boat at the time of manufacture to alert operators to potential hazards that may not be obvious. These labels also indicate how to avoid hazards. Warning labels should never be removed and must remain legible.

**If you suspect a label is missing, or if a label becomes damaged or becomes unreadable (damaged, faded, or sun bleached), you should have it replaced immediately.**

**To replace a warning label, contact your MasterCraft dealer with a label part number, which can be found by visiting [MasterCraft.com/manuals](http://MasterCraft.com/manuals), and request a new label.**

The label's part number is located in the bottom right corner of every label (shown circled in green on the label to the right).

It is the responsibility of the boat owner and occupants of the boat to understand and comply with all warning labels and safety recommendations and requirements. The operator of the boat and the boat owner are responsible for the proper operation of the boat and the safety of the occupants of the boat. Failure to adhere to and

comply with the on-product warning labels and safety statements labeled as dangers, warnings, and cautions that appear in this manual can lead to serious injury, or death, as well as property damage. **READ AND ADHERE TO ALL WARNING PLATES AND LABELS** from bow to stern, including those that are installed inside the engine compartment, lockers, and underneath seating.



**OTHER  
IMPORTANT  
INFORMATION**

# COMMUNICATIONS

## The following applies to the Great Lakes and salt water boating:

When boating off-shore, carry communications gear such as a marine VHF-FM and/or HF transceiver(s), appropriate to the operating area. Cellular phone coverage is available in many coastal areas. However, cellular phones should NOT be considered a substitute for VHF-FM marine band radios for emergency purposes.

In distress situations, press the VHF transmit button and clearly say: MAYDAY, MAYDAY, MAYDAY. Follow this with the vessel name and/or description, the location, nature of emergency and number of people on-board. Then release the transmit button and wait for 10 seconds. If there is no response, repeat the MAYDAY call.

Satellite EPIRBs (406 MHz) are designed to quickly and reliably alert rescue forces, indicate an accurate distress position, and guide rescue units to the distress scene, even when all other communications fail.

When activated, the satellite EPIRB transmits a distress signal with a beacon-unique identifying code. The system detects the signal, calculates an accurate distress position, checks the unique identifying code against the EPIRB registration database (vessel and point of contact information supplied by the owner) and routes the distress alert with registration information to the responsible U.S. Coast Guard (or International) Rescue Coordination Center (RCC).

406MHz EPIRBs with GPS (internal or attached) also provide an immediate GPS position in the information passed to the RCC.

Geostationary satellites make detection almost immediate. If the EPIRB does not have the ability to provide a GPS position, the process to determine a position takes about an hour on average and almost always less than two hours. Satellite EPIRBs also include a homing beacon and strobe to help rescue forces quickly locate the distress scene.

Satellite beacons have significant coverage, alerting timeliness, position accuracy, and signaling advantages over other types of EPIRBs (121.5 MHz). Before purchasing or using something other than the 406 MHz EPIRB, be sure to understand the capabilities and limitations.

Further information and a complete listing of VHF channels and frequencies is available at: [www.navcen.uscg.gov](http://www.navcen.uscg.gov).

# INSURANCE

Even if someone else is operating the boat, the owner is generally held liable for any damages or injuries that occur. It is in the owner's best interest to maintain sufficient personal liability and property damage insurance on the boat in anticipation of potential judgments. Guarding against theft is another consideration.

# WEATHER

Never leave the dock without first checking the local weather forecast. Weather information is available from television, radio, local newspaper, online or from a weather channel on a VHF radio.

At certain times of the year, weather can change rapidly and boaters should always keep an eye out for weather conditions.

## **While boating, pay attention to the following:**

- Watch for cloud build-up, especially rapid, vertically rising clouds.
- Sudden drop in temperature.
- Sudden change in wind direction and/or speed.
- On-board barometers, where placed on-board by the boat owner, should be checked every two-to-three hours. A rising barometer indicates fair weather and a rise in wind velocity; a falling barometer indicates stormy or rainy weather.

## **What to do in severe weather:**

- Reduce speed, keeping enough power to maintain headway.
- Put on PFDs.
- Turn on running lights.
- Head for the nearest shore or safe harbor that is safe to approach, if possible.
- Head bow of boat into waves at 45-degree angle, if possible.
- Keep bilges free of water.

- Seat passengers on bottom of the boat, near the centerline.
- If the engine fails, tie a sea anchor on a line from the bow of the boat to keep the boat headed into the waves. A bucket will work as a sea anchor in an emergency.
- Anchor the boat, if necessary.
- Seek shelter on-shore whenever possible. Particularly avoid riding out a storm that includes high wind and/or lightning, which is especially dangerous. Avoid contact with metal portions of the boat such as handrails, windshields, tower and cleats.

# NAUTICAL CHARTS

Nautical charts are especially important to boaters planning trips, particularly on open waters. These charts show the nature and shape of the coast, depths of water, general configuration and character of the bottom of the body of water. Other markings on the nautical charts include prominent landmarks, port facilities, aids to navigation, and marine hazards. Changes brought about by people and nature require that nautical charts be constantly maintained and updated to aid safe navigation.

National Ocean Service (NOS) charts may be purchased either directly by mail from the NOS Distribution Branch or through an authorized agent. There are more than 1,700 nautical chart agents who sell them.

## FAA/NATIONAL AERONAUTICAL CHARTING OFFICE

Distribution Division, AVN-530

1305 East-West Highway

Silver Spring, MD 20910

Telephone: (301) 427-5000

Email: 9-AMC-aerochart@faa.gov

<http://naco.faa.gov/>

## FLOAT PLAN

A “float plan” is a written record indicating the planned destination and approximate length of time for the outing. Sample forms are available at the Coast Guard’s website. One should be completed and left with a relative or friend prior to each trip. In case of an emergency or failure to return within a reasonable period of time, pertinent information will be available to assist local marine police or the Coast Guard in determining whether a search should be performed. Be sure to notify the float plan holder upon return.

## STAYING AFLOAT

It is commonly believed that someone dressed in heavy clothing or waders will experience considerably more difficulty staying afloat if they fall overboard. This is not true. Air trapped in clothing provides flotation and bending the knees will trap air in waders.

### To stay afloat:

- Remain calm. Do not thrash about or try to remove clothing or footwear. This leads to exhaustion and increases the loss of air that may keep you afloat.
- Keep your PFD on.
- Keep your knees bent.
- Float on your back and paddle slowly to safety.

## COLD WATER SURVIVAL

Sudden immersion in cold water can induce rapid, uncontrolled breathing, cardiac arrest and other physical body conditions, which can lead to drowning. Always wearing a PFD will help survival in rapid immersion situations.

### In other situations when entry into cold water is necessary:

- Wear a PFD.
- Button all clothing.
- Cover your head if possible and enter the water slowly.
- Keep your head out of the water if at all possible.
- Assume the Heat Escape Lessening Posture (HELP) position as taught within a Coast Guard-taught safety course. Information about HELP is available online.

Immersion in water speeds the loss of body heat and can lead to

hypothermia, the abnormal lowering of internal body temperature. If a boat capsizes, it will likely float on or just below the surface.

To reduce the effects of hypothermia, get in or on the boat. Try to get as much of your body out of the water as possible. If you can't get in the boat, a PFD will enable you to keep your head out of the water. This is very important because about 50 percent of body heat loss is from the head.

It may be possible to revive a drowning victim who has been under water for some time and shows no sign of life. Cases document instances where victims have been resuscitated after extended periods. Start CPR immediately and get the victim to a hospital as quickly as possible.

Immersion suits will delay the effects of hypothermia in cold water and are available through many retailers who specialize in sales of marine products. The suits should be stored and maintained according to the manufacturer's instructions.

## **INFLATABLE LIFE RAFTS**

An inflatable life raft can provide a survival platform for an extended period of time. Be sure the life raft is large enough for everyone on board when the boat operates off-shore. It should have the appropriate emergency equipment pack and should be professionally serviced periodically, according to the manufacturer's instructions.

Coast Guard-approved life rafts must meet a number of stringent material and performance standards.

## **ANCHORING**

Anchoring is done for two principal reasons: first, to stop for fishing, swimming, lunch or an overnight stay, and secondly, to keep a boat from running aground in bad weather or as a result of engine failure.

When preparing to anchor, bring the bow of the vessel into the wind or current. Place the engine in neutral. When the boat comes to a stop, slowly lower the anchor. Do not throw the anchor over as it will tend to foul the anchor or tangle line. When the anchor line has been let out, back up away from the anchor with the engine in idle reverse to help set the anchor. After it is firmly set, use reference points (landmarks) in relation to the boat to be sure that the boat is not drifting. Check the points frequently.





# RULES OF THE OPEN WATER

Just as there are rules that apply when driving a vehicle on the street, there are waterway rules that apply when driving a boat on the water. These rules are used internationally, and they are enforced by the United States Coast Guard and local agencies. You should be aware of these rules and follow them whenever you encounter another vessel on the water.

In various geographic locations, certain rules prevail that may be unique to the locale. Each state also has laws and boating limitations that may be applicable only within their boundaries. It is the operator's responsibility to seek out this information and become familiar with all safety-related information, laws and rules governing boating operation.

The rules presented in this Owner's Manual are condensed and have been provided for convenience only. Consult your local U.S. Coast Guard Auxiliary (USCGA), Department of Motor Vehicles (DMV) or Department of Natural Resources (DNR) for a complete set of rules governing the waters in which you will be using your boat. If you plan to travel—even for a short trip—you would be well-served to contact the regional USCGA, DMV or DNR in the area where you will be boating. Often, basic information is available through websites sponsored and prepared by these organizations and governing bodies.

# STEERING AND SAILING RULES/ SOUND SIGNALS

Any time two (2) vessels on the water meet one another, one vessel has the right-of-way. It is called the stand-on vessel. The vessel that does not have the right-of-way is called the give-way or burdened vessel.

These rules determine which vessel has the right of way, and accordingly, what each vessel should do.

The vessel with the right-of-way has the duty to continue its course and speed, except to avoid an immediate collision. When you maintain your direction and speed, the other vessel will be able to determine how best to avoid you.

The vessel that does not have the right of way has the duty to take positive and timely action to stay out of the way of the stand-on vessel. Normally, the give-way vessel should not cross in front of the stand-on vessel, but should slow down or change direction briefly and pass behind the other vessel. You should always move in such a way that the stand-on operator can see what you are doing if you are operating the give-way vessel.

# GENERAL PRUDENTIAL RULE

This rule is called Rule 2 in the International Rules and says, *“In obeying and construing these rules due regard shall be had to all dangers of navigation and collision, and to any special circumstances, which may render a departure from the above rules necessary in order to avoid immediate danger.”*

# RULES WHEN ENCOUNTERING VESSELS

There are three (3) main situations in which you may encounter other vessels, and you must avoid a collision. These are:

- Meeting (you are approaching another vessel head-on).
- Crossing (you are traveling across the other vessel's path).
- Overtaking (you are passing or being passed by another vessel).

# MEETING

If you are meeting another vessel head-on, and you are close enough to run the risk of collision, neither of you has the right-of-way. Both of you should alter course to avoid an accident. You should keep the other vessel on your port (left) side. (This rule doesn't apply if both of you can clear each other by continuing your set course and speed.)

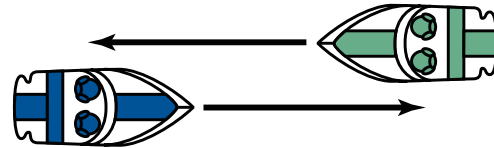
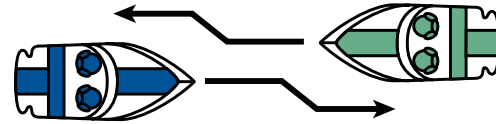
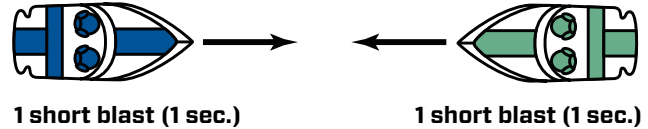
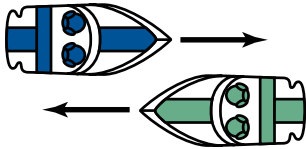
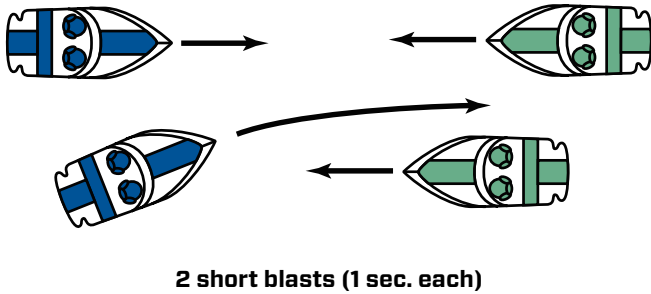

# CROSSING

When two (2) power-driven vessels are crossing each other's path close enough to run the risk of collision, the vessel that views the crossing vessel to the starboard (right) side must give way.

If the other vessel is to the port (left) side, you are the stand-on vessel, and provided the other vessel gives you the right-of-way, maintain your course and direction.

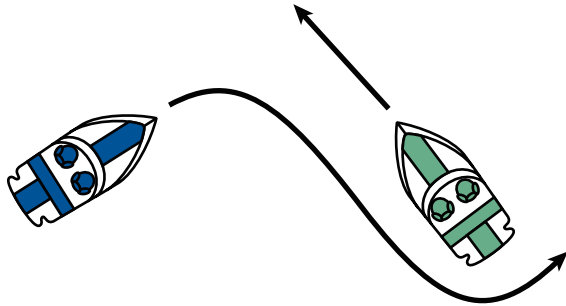

# OVERTAKING

If you are passing another vessel, you are the give-way vessel. This means that the other vessel is expected to maintain its course and speed. You must stay out of its way as you clear it, altering course and speed as necessary.

Conversely, if you are being passed by another vessel, you are the stand-on vessel, and you should maintain your speed and direction so that the vessel can be steered around you.

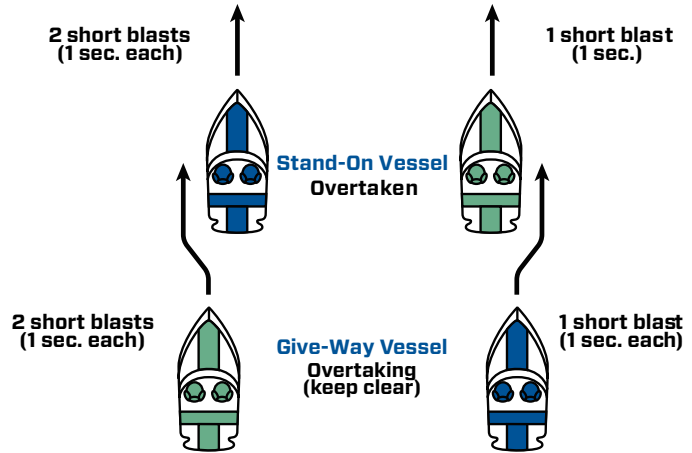

# SAILING VESSEL RIGHT-OF-WAY

Sailing vessels should normally be given the right-of-way. The exceptions to this are:

- When the sailing vessel is overtaking the power-driven vessel, the power-driven vessel has the right-of-way.
- Sailing vessels should keep clear of any fishing vessel.
- In a narrow channel, a sailing vessel should not hamper the safe passage of a power-driven vessel that can navigate only in such a channel. A sailing vessel that is underway but not using sails is considered a power vessel and should be treated like any other power vessel when determining right of way.

# FISHING VESSEL RIGHT-OF-WAY

Under international rules, all vessels that are fishing with nets, lines or trawls are considered to be fishing vessels; however, boats with trolling lines are not considered fishing vessels.

Fishing vessels have the right of way, regardless of position, but these vessels cannot impede the passage of other vessels in narrow channels.

# OTHER SPECIAL SITUATIONS

There are additional rules to remember when operating your boat around other vessels, such as:

- When navigating in narrow channels, you should keep to the right when it is safe and practical to do so.
- When preparing to go around a bend that may obstruct your view of other water vessels, you should sound a prolonged blast on the horn or with a whistle for four (4) to six (6) seconds. Even if no reply is heard, you should still proceed around the bend with caution.

# READING BUOYS AND OTHER MARKERS

The waters of the United States are marked for safe navigation by the lateral system of buoyage. The markers and buoys you encounter will have an arrangement of shapes, colors, numbers and lights to show which side of the buoy a boater should pass when navigating in a particular direction.

The Uniform State Waterway Marker System has been devised for these waters. This system uses buoys and signs with distinctive shapes and colors to show regulatory or advisory information. The markings on these buoys are oriented from the perspective of being entered from a seaward direction while the boater is going

toward the port. Red buoys are passed on the starboard (right) side when proceeding from open water into port, and green buoys are passed on the port (left) side. When navigating out of port, your position to the buoys should be reversed: red buoys to port (left) and green buoys to starboard (right).

## Uniform State Waterway Marker System

**Green or Black Channel Marker Buoy:** Traveling upstream, you should pass to the right of the buoy as it marks the left side of the channel.

**Red Channel Marker Buoy:** Traveling upstream, you should pass to the left of this buoy as it marks the right side of the channel.

**Junction Buoy (Green over Red):** Means two channels are coming together and you should pass to the right of the buoy as you travel upstream.

**Junction Buoy (Red over Green):** Means two channels are coming together and you should pass to the left of the buoy as you travel upstream.

**Passing Daymark (Green):** A sign mounted on poles in the water or on the bank which is used in the same manner as a channel marker buoy. In this case it marks the left side of the channel as you travel upstream.

**Passing Daymark (Red):** A sign mounted on poles in the water or on the bank which is used in the same manner as a channel marker buoy. In this case it marks the right side of the channel as you travel upstream.

**Channel Crossing Daymark (Green):** A sign mounted on poles in the water or on the bank which means the channel is crossing from the left bank to the right bank as you travel upstream.

**Channel Crossing Daymark (Red):** A sign mounted on poles in the water or on the bank which means the channel is crossing from the right bank to the left bank as you travel upstream.

**Boats Keep Out Buoy:** Marks a swimming area, an area near a dam or any area where boats are not allowed.

**Danger Buoy:** Marks an obstruction, ferry cable, or any area where boats should not navigate or should use extreme caution.

**Information Buoy:** Used to relay information. Words printed in black (usually inside the border) tell place names, distances, directional arrows, availability of supplies, gasoline, etc.

**Control Buoy:** Marks a restricted area such as “slow no-wake,” “5 MPH, no skiing or no fishing.”

**Mooring Buoy:** Means an anchor buoy. This is the only buoy to which a boat may tie or secure to.

**Diver’s Flag:** Must be used any time a diver is in the water. Boats must not come closer than 50 feet of the flag and must operate at a slow, no-wake speed within 200 feet.

**Alpha Flag:** Means a vessel is engaged in diving operations or is restricted in its ability to navigate. Boaters must use extreme caution and are advised to look for a diver’s-down flag.

**NOTE: Markings may vary by geographic location. For example, the Western Rivers System markers are slightly different, as well as in different states or jurisdictions. Always consult appropriate boating authorities before boating in unfamiliar waters.**

# WAKE RESPONSIBLY

**1** Stay at least 200 feet away from the shoreline, docks, or other structures.

**2** Keep music at reasonable levels. Sound travels well over water.

**3** Minimize repetitive passes on any one portion of shoreline.

Remember, you are responsible for your own wake.

Take The Pledge at: [WakeResponsibly.com](https://www.wakeresponsibly.com)







# **2022 MODEL FEATURES AND SPECS**



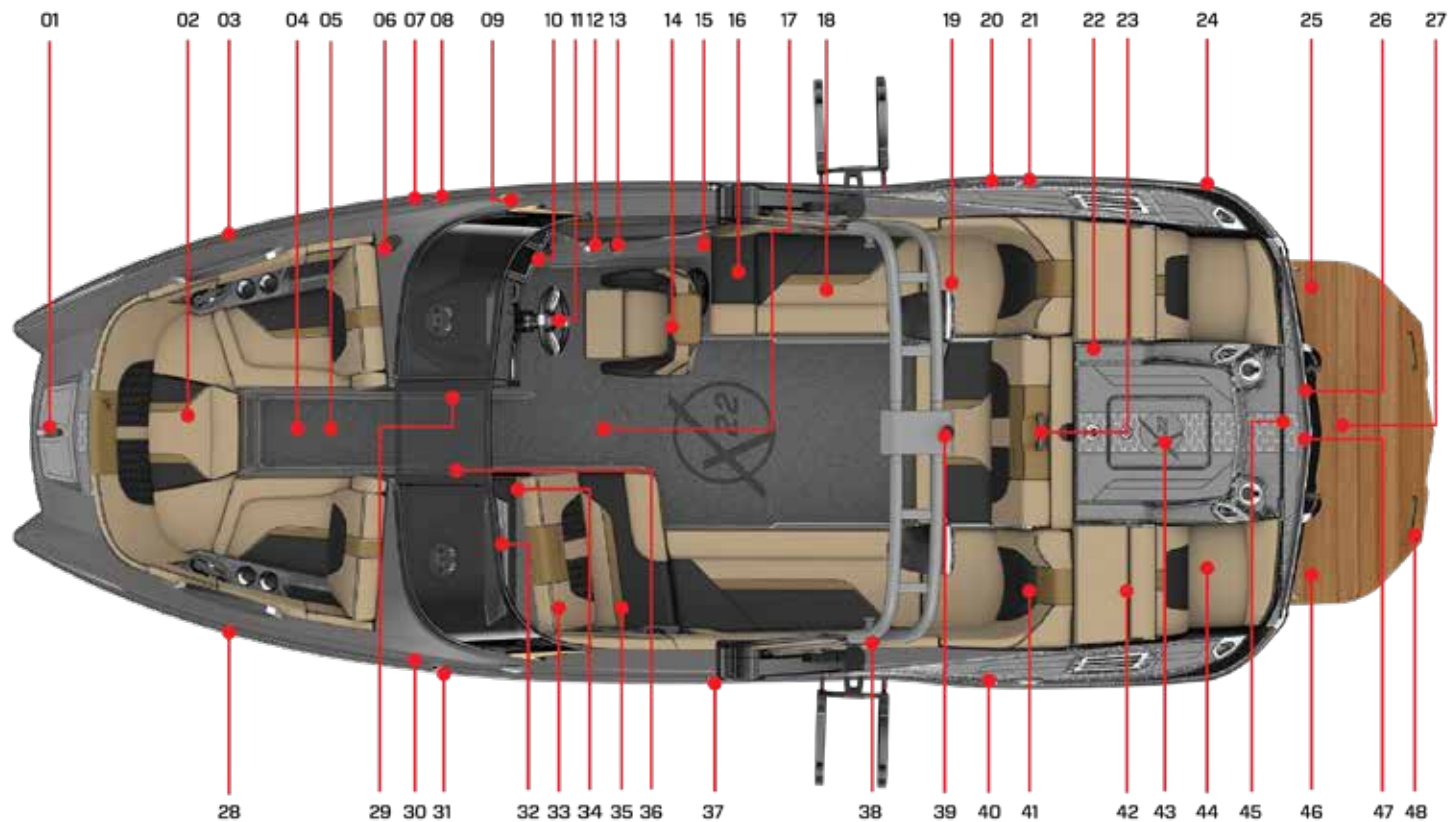

## FEATURES

01. Forward cleat
02. Anchor storage
03. Horn
04. Bow filler cushion (where equipped)
05. Forward ballast tank
06. ZeroOff GPS Puck
07. Ballast thru-hull outlets
08. Navigation light
09. Midship cleat
10. Instrument panel
11. Steering wheel
12. Shift/throttle control
13. Engine shut-off lanyard
14. Heated backrest (where equipped)
15. Fire suppression unit manual override
16. Flip-up headrest
17. Center drain plug
18. Cooler
19. Starboard ballast tank
20. Ballast thru-hull outlet
21. Stern cleat
22. Engine flush valve (inside engine compartment)
23. Convertible center rear seating (where equipped)
24. Bilge thru-hull outlet
25. Surf tab
26. Transom stereo remote (where equipped)
27. Stern thruster (where equipped); underwater exhaust tip; center surf tab

28. Horn
29. Circuit breaker panel; battery switch
30. Amp and amp board
31. Navigation light
32. Glove box
33. Handheld fire extinguisher
34. Observer remote (where equipped)
35. Battery/batteries
36. Trash can door
37. Fuel tank fill
38. Tower with clamping board racks
39. Anchor light and tow point
40. Ballast thru-hull outlets
41. Port ballast tank
42. Surf Star ballast bags (where equipped; beneath sundeck)
43. Engine compartment; engine
44. Flip-up rear seating
45. Automatic fire extinguisher (inside engine compartment)
46. Surf tab
47. Transom drain plug
48. Swim platform

## SPECIFICATIONS

Length of Boat 22' 4"

Width Amidship 102"

Boat Weight 5,800 lbs.

Length of Boat w/Platform 24' 5"

Towing Length 27' 8"

Towing Width 102"

Fuel Capacity 68 gallons

Maximum Capacity 16 people  
or 2,250 lbs.

Bow Capacity: 5 people or 750 lbs.

Weight must be evenly distributed.

# X22

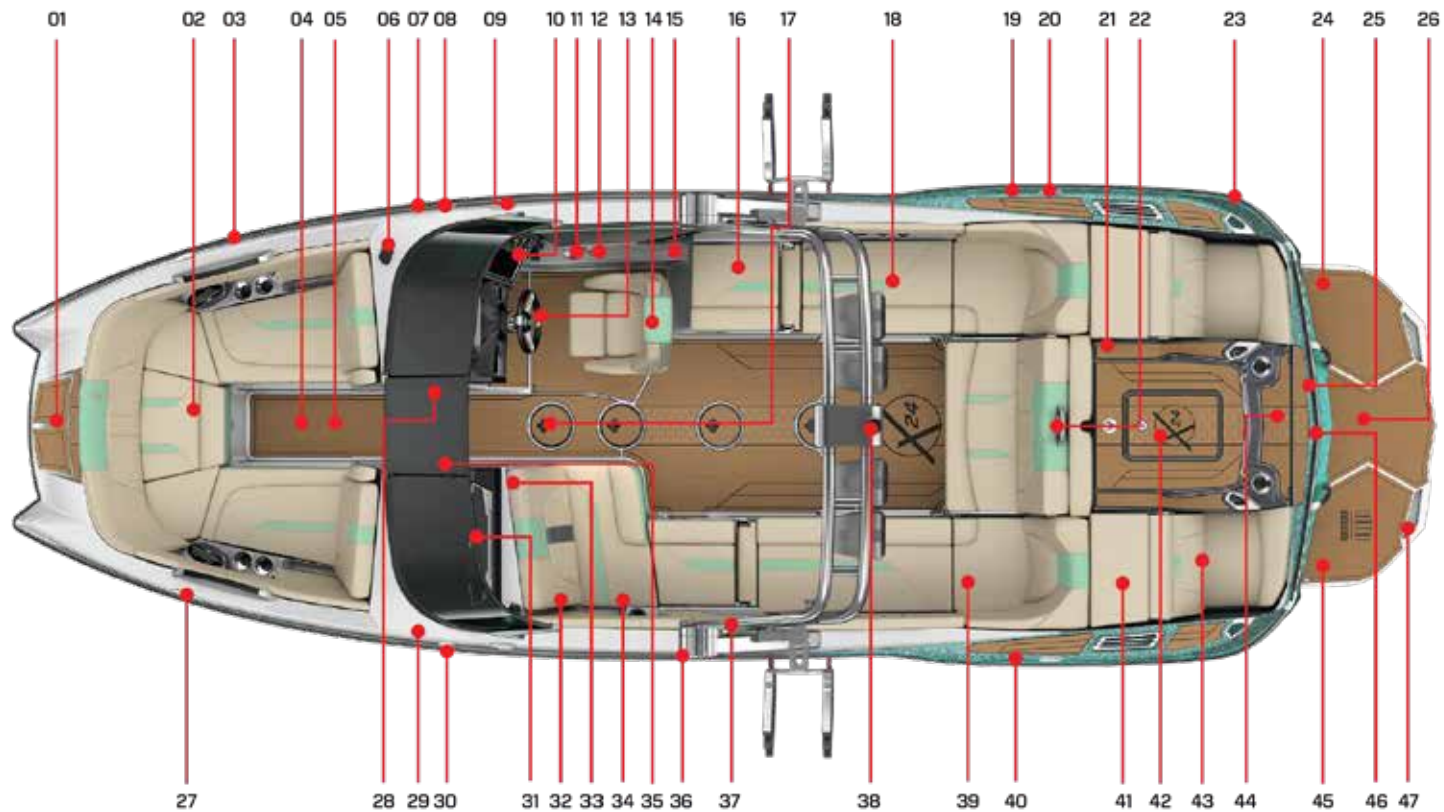

## FEATURES

01. Forward cleat
02. Anchor storage
03. Horn
04. Bow filler cushion (where equipped)
05. Forward ballast tank
06. ZeroOff GPS puck
07. Ballast thru-hull outlet
08. Navigation light
09. Midship cleat
10. Instrument panel
11. Shift/throttle control
12. Engine cutoff lanyard
13. Steering wheel
14. Heated seat (where equipped)
15. Fire suppression unit manual override
16. Flip-up backrest
17. Center drain plug
18. Cooler
19. Ballast thru-hull outlets
20. Stern cleat (one on each side)
21. Engine flush valve
22. Convertible center rear seating (where equipped)
23. Bilge thru-hull outlet
24. Surf tab
25. Transom stereo remote (where equipped)
26. Stern thruster (where equipped); center tab; underwater exhaust
27. Forward cleat
28. Circuit breaker panel; battery switch
29. Amp board
30. Navigation light
31. Glove box
32. Handheld fire extinguisher
33. Observer remote (where equipped)
34. Battery or batteries
35. Trash can door
36. Fuel tank fill
37. Tower with clamping board racks
38. Anchor light and tow point
39. Port ballast tank
40. Ballast thru-hull outlet
41. Optional Surf Star ballast bag (where equipped)
42. Engine compartment; engine
43. Flip-up seating
44. Automatic fire extinguisher
45. Surf tab
46. Transom drain plug
47. Swim platform

## SPECIFICATIONS

Length of Boat 24' 2"

Width Amidship 102"

Boat Weight 6,100 lbs.

Length of Boat w/Platform 26' 2"

Towing Length 29' 2"

Towing Width 102"

Fuel Capacity 85 gallons

Maximum Capacity 18 people  
or 2,550 lbs.

Bow Capacity: 5 people or 750 lbs.

Weight must be evenly distributed.

# X24

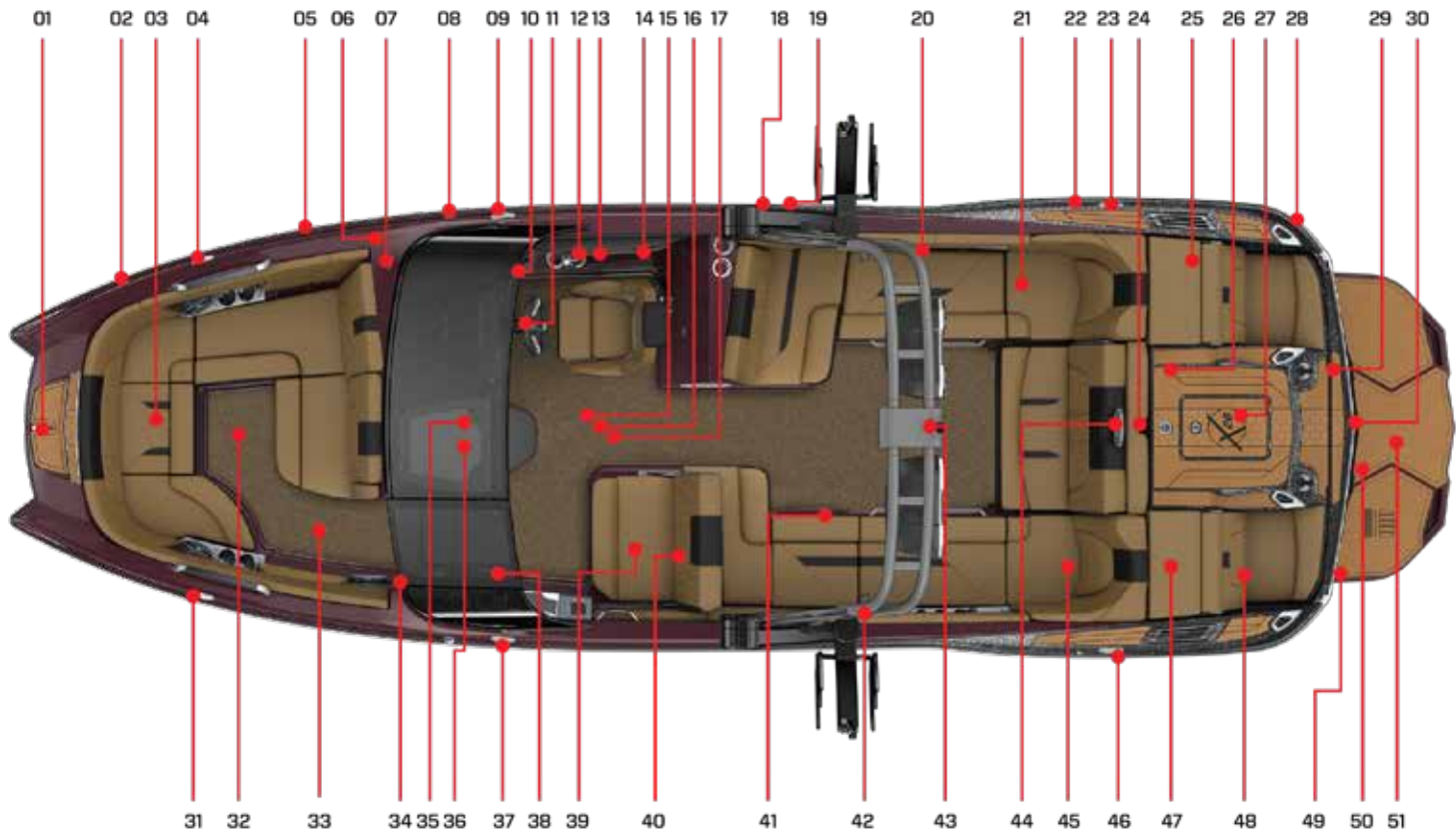



## FEATURES

1. Bow cleat
2. Horn
3. Anchor storage
4. Forward cleat
5. Bilge thru-hull vent
6. Waste tank pump-out
7. ZeroOff GPS puck
8. Navigation light
9. Midship cleat
10. Instrument panel
11. Steering wheel
12. Throttle control
13. Engine shut off lanyard
14. Fire suppression unit manual override
15. Center drain plug (under hatch)
16. Freshwater tank access (under floor hatch, where equipped)
17. Overboard discharge access (under floor hatch, where equipped)
18. Ballast thru-hull outlet
19. Fuel tank filler
20. Wireless cockpit chargers (where equipped)
21. Starboard ballast tank
22. Ballast thru-hull outlets
23. Midship cleat
24. Ski pylon attachment point
25. Surf Star ballast bag (where equipped; beneath sundeck)
26. Engine flush valve
27. Engine compartment; engine
28. Bilge thru-hull outlet
29. Transom remote (where equipped)
30. Transom drain plug
31. Forward cleat
32. Bow filler cushion (where equipped)
33. Forward ballast tank
34. Amp board
35. Storage compartment/head (where equipped)
36. Handheld fire extinguisher (where equipped)
37. Midship cleat
38. Circuit breaker panel; battery switch
39. Batteries (under seat)
40. Convertible observer seat
41. Slide out refrigerator (where equipped)
42. Tower with clamping board racks
43. Anchor light and tow point
44. Convertible center rear seating
45. Port ballast tank
46. Stern cleat
47. Surf Star ballast bags (where equipped)
48. Flip-up back facing seat (where equipped)
49. Surf tab (one on each side of the boat and in center beneath platform)
50. Swim platform
51. Stern thruster (where equipped); underwater exhaust tip; center surf tab

## SPECIFICATIONS

Length of Boat 26' 5"

Width Amidship 102"

Boat Weight 6,900 lbs.

Length of Boat w/Platform 28' 5"

Towing Length 31' 5"

Towing Width 102"

Fuel Capacity 108 gallons

Maximum Capacity 18 people/Yacht

Certified

Bow Capacity: 5 people or 750 lbs.

Weight must be evenly distributed.

# X26

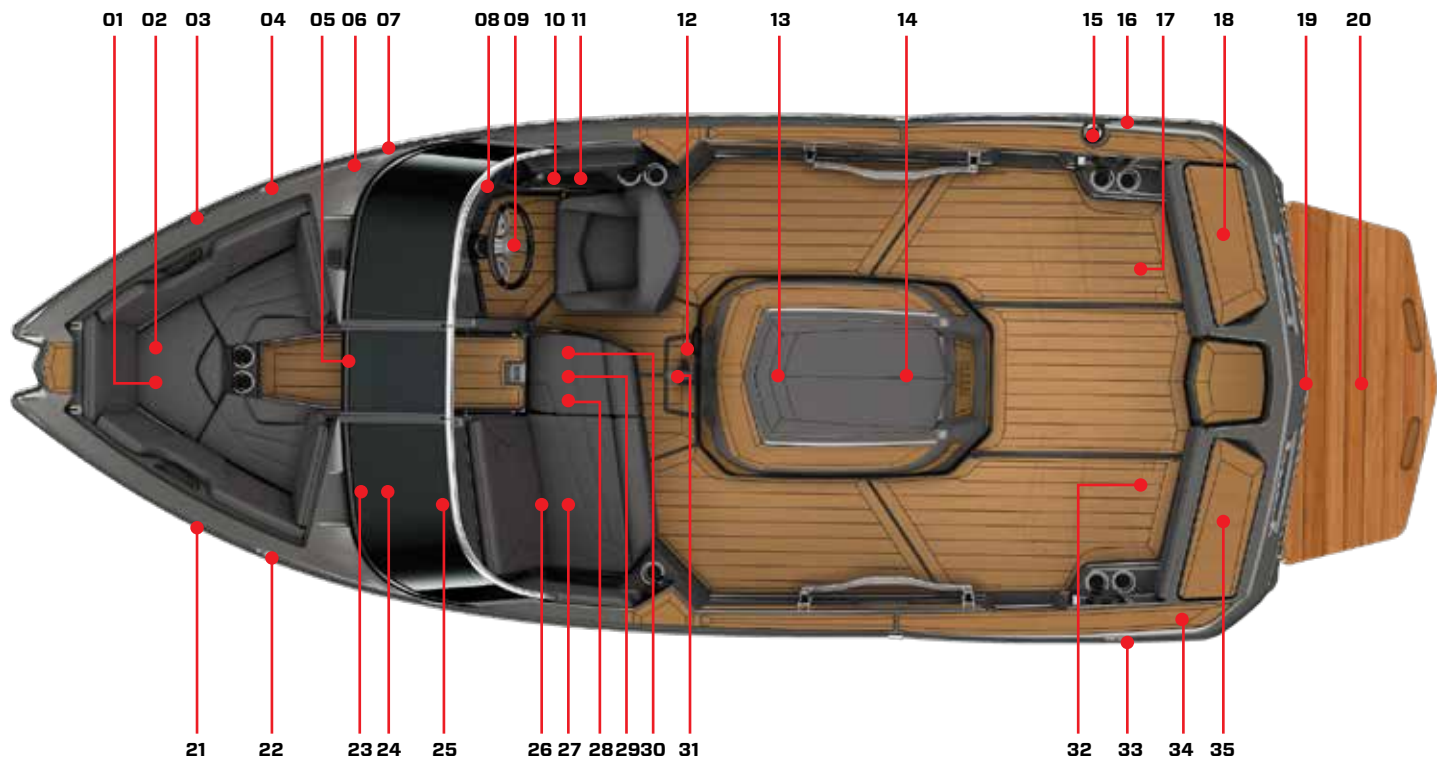

## FEATURES

01. Bow hatch (where equipped)
02. Bow seating (where equipped)
03. Bow cleat (where equipped)
04. Navigation light
05. Drop-in walk-thru door
06. Bilge thru-hull outlet
07. Adjustable mirror
08. Instrument panel
09. Steering wheel
10. Shift-throttle control
11. Fire suppression unit manual override
12. Jump switch wire hole
13. Engine compartment
14. Automatic fire extinguisher (inside engine compartment)
15. Fuel tank filler
16. Stern cleat (where equipped)
17. Aft seating (where equipped)
18. Aft storage compartment
19. Engine exhaust turndowns
20. Swim platform
21. Bow cleat (where equipped)
22. Navigation light
23. Heater (where equipped)
24. Battery (beneath storage door)
25. Glove box
26. MTS Ballast System (where equipped, beneath observer seat)
27. Hand-held fire extinguishers (beneath observer seat)
28. Drain plug
29. Folding walk-thru seat
30. Battery switch; circuit breaker board
31. Ski pylon
32. Aft seating (where equipped)
33. Stern cleat (where equipped)
34. Stern light receptacle (if equipped with tower, the light will be in center aft of tower)
35. Aft storage compartment

## SPECIFICATIONS

Length of Boat 20'0"

Width Amidship 96"

Boat Weight 3,300 lbs.

Length of Boat w/Platform 21' 6"

Towing Length 25' 11"

Towing Width 100"

Fuel Capacity 30 gallons

Maximum Capacity 7 people

or 1,341 lbs.

Bow Capacity: 2 people or 300 lbs.

Weight must be evenly distributed.

*Storage space is located under:  
Observer's seat, bow seating.*

# PROSTAR

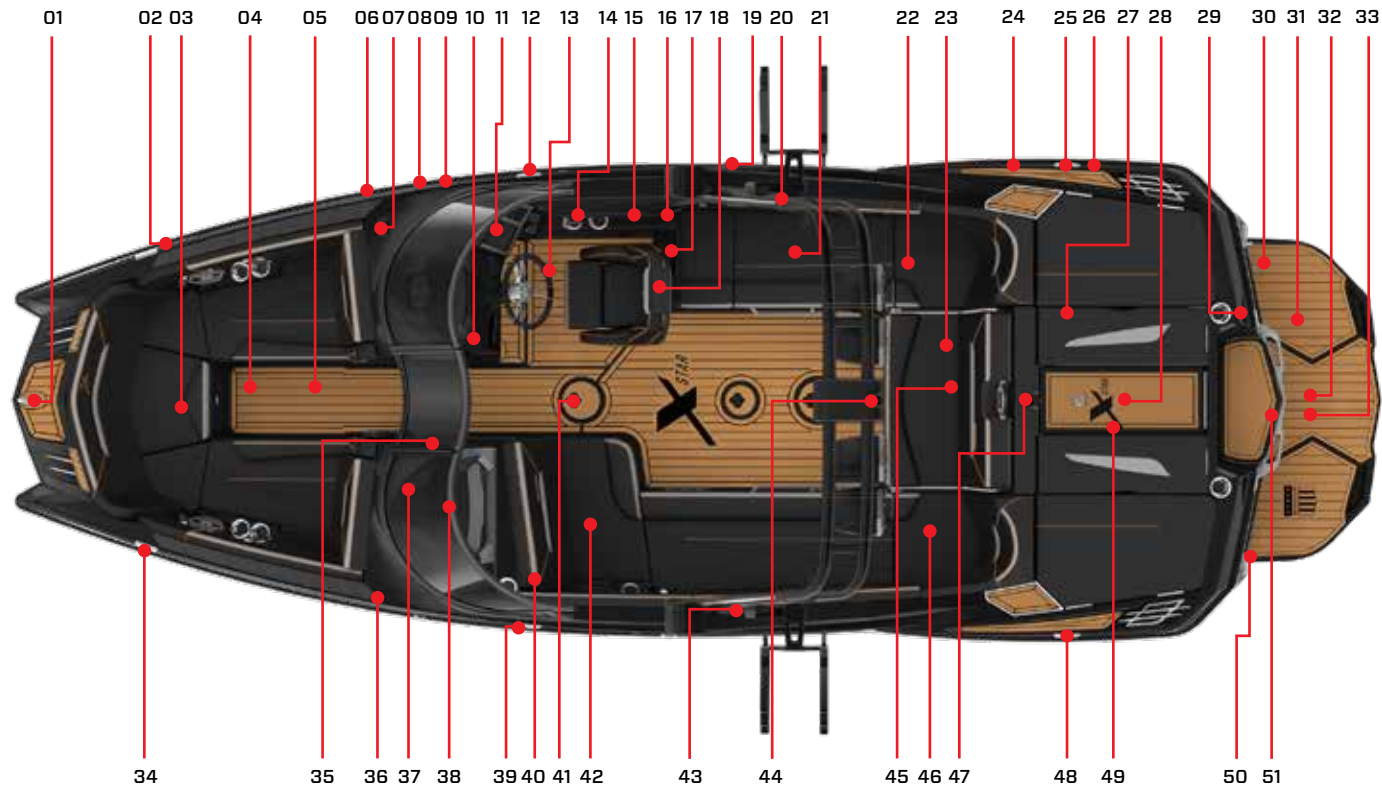

## FEATURES

01. Forward cleat
02. Horn
03. Anchor storage
04. Bow filler cushion (where equipped)
05. Forward ballast tank (beneath floorboard)
06. Ballast thru-hull outlet
07. ZeroOFF GPS puck
08. Bilge thru-hull vents
09. Navigation light
10. Battery ON/OFF switch; circuit breaker panel
11. Instrument panel
12. Midship cleat
13. Steering wheel
14. Shift/throttle control
15. Engine cutoff lanyard
16. Fire suppression unit manual override
17. Subwoofer
18. Heated driver's seat (where equipped)
19. Fuel tank filler
20. Wireless charging devices
21. Cooler (under seat)
22. Starboard ballast tank (under floor)
23. Midship ballast tank (under floor)
24. Ballast thru-hull outlet
25. Stern cleat
26. Bilge thru-hull outlet
27. Engine flush valve (inside engine compartment)
28. Engine compartment
29. Transom stereo remote (where equipped)
30. Surf tab (one on each side of the boat and in

- center beneath platform)
31. Swim platform
32. Stern thruster (where equipped);  
underwater exhaust tip
33. Center surf tab
34. Forward cleat
35. Trash can door
36. Amp board and amps
37. Batteries
38. Glove box
39. Midship cleat
40. Handheld fire extinguisher
41. Center drain plug
42. Heated observer seat
43. Tower with clamping board racks
44. Anchor light and tow point
45. Convertible center rear seating (where  
equipped)
46. Port ballast tank (under floor)
47. Removable pylon (where equipped)
48. Stern cleat
49. Engine
50. Underwater lights (where equipped)
51. Transom drain plug

## SPECIFICATIONS

Length of Boat 23' 0"

Width Amidship 102"

Boat Weight 5,800 lbs.

Length of Boat w/Platform 25' 0"

Towing Length 28' 4"

Towing Width 102"

Fuel Capacity 76 gallons

Maximum Capacity 16 people

or 2,400 lbs.

Bow Capacity: 5 people or 750 lbs.

Weight must be evenly distributed.

# XSTAR

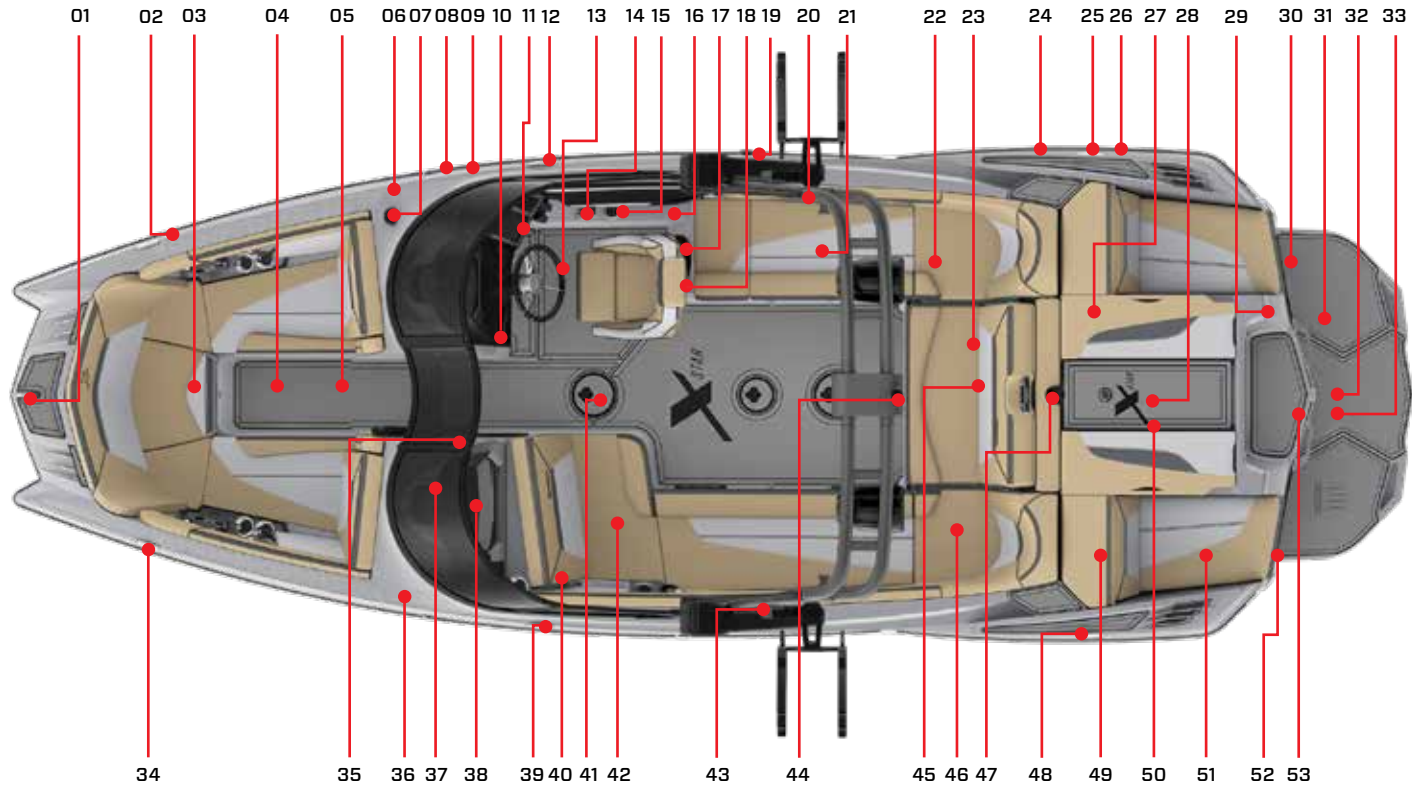

## FEATURES

01. Forward cleat
02. Horn
03. Anchor storage
04. Bow filler cushion (where equipped)
05. Forward ballast tank (beneath floorboard)
06. Ballast thru-hull outlet
07. ZeroOFF GPS puck
08. Bilge thru-hull outlet
09. Navigation light
10. Circuit breaker panel; battery switch
11. Instrument panel
12. Midship cleat
13. Steering wheel
14. Shift/throttle control
15. Engine cutoff lanyard
16. Fire suppression unit manual override
17. Subwoofer
18. Heated driver's seat (where equipped)
19. Fuel tank filler
20. Wireless charging devices (where equipped)
21. Cooler (under seat)
22. Starboard ballast tank (under floor)
23. Midship ballast tank (under floor)
24. Ballast thru-hull outlet
25. Stern cleat
26. Bilge thru-hull outlet
27. Engine flush valve (inside engine compartment)
28. Engine compartment
29. Transom stereo remote (where equipped)
30. Surf tab (one on each side of boat)
31. Swim platform
32. Stern thruster (where equipped); underwater exhaust tip
33. Center surf tab
34. Forward cleat
35. Trash can door
36. Amp board and amps
37. Batteries
38. Glove box
39. Midship cleat
40. Handheld fire extinguisher
41. Center drain plug
42. Heated observer seat (where equipped)
43. Tower with clamping board racks
44. Anchor light and tow point
45. Convertible center rear seating (where equipped)
46. Port ballast tank (under floor)
47. Ski pylon attachment point
48. Stern cleat
49. Surf Star ballast bag (beneath sundeck)
50. Engine
51. Flip-up rear seating
52. Underwater lights (where equipped)
53. Transom drain plug

## SPECIFICATIONS

Length of Boat 23' 0"

Width Amidship 102"

Boat Weight 5,800 lbs.

Length of Boat w/Platform 25' 0"

Towing Length 28' 4"

Towing Width 102"

Fuel Capacity 76 gallons

Maximum Capacity 16 people  
or 2,400 lbs.

Bow Capacity: 5 people or 750 lbs.

Weight must be evenly distributed.

# XSTAR S

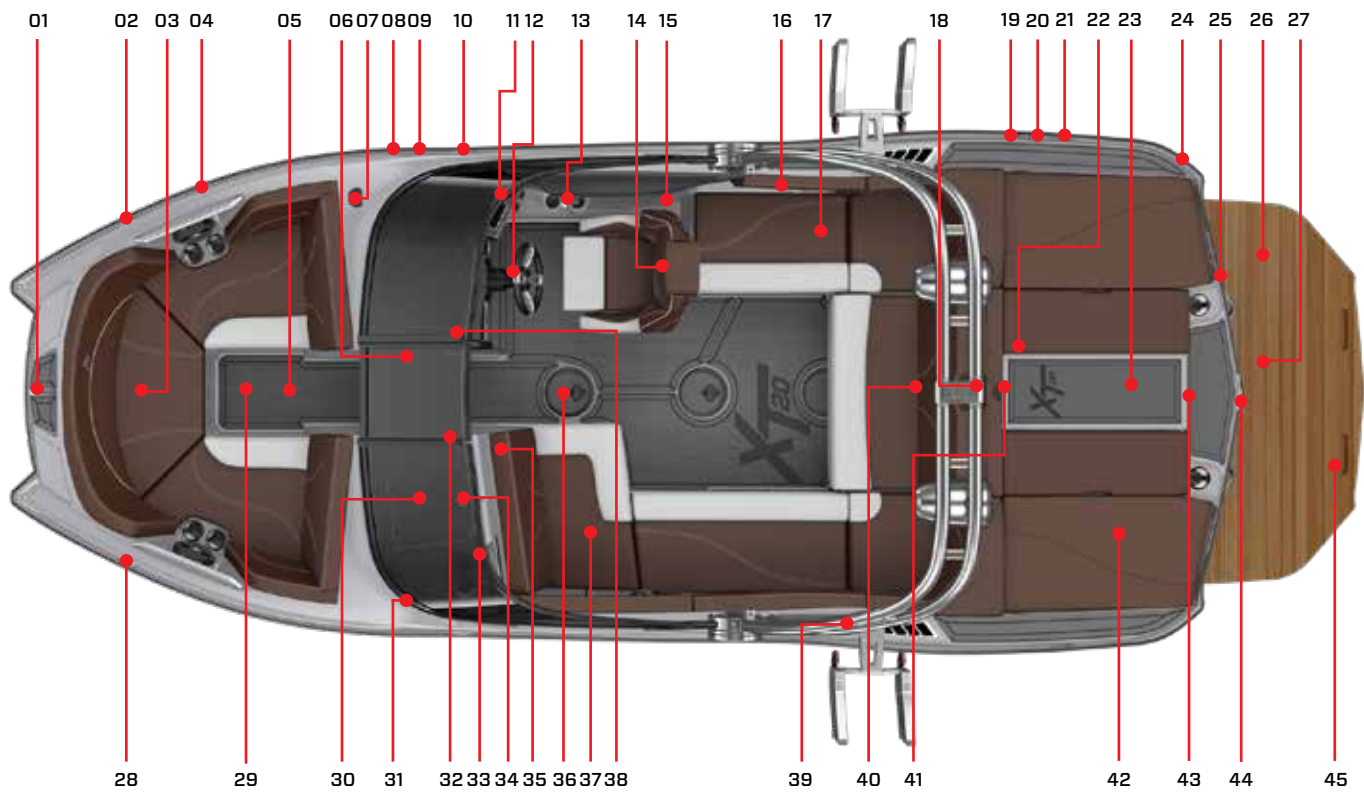



## FEATURES

01. Bow cleat
02. Navigation light
03. Anchor storage
04. Horn
05. Ballast tank (below deck)
06. Bow subwoofer
07. ZeroOff GPS puck
08. Bilge thru-hull outlet
09. Ballast thru-hull outlet
10. Midship cleat
11. Instrument panel
12. Steering wheel
13. Throttle control and emergency stop switch
14. Heated seat (where equipped)
15. Fire suppression unit manual override
16. Wireless cockpit chargers (where equipped)
17. Cooler (under seat)
18. Anchor light and tow point
19. Ballast thru-hull outlet
20. Stern cleat
21. Fuel tank fill
22. Engine flush valve
23. Engine compartment
24. Bilge thru-hull outlet
25. Transom remote (where equipped)
26. Surf tab (one on each side of boat)
27. Center tab
28. Horn
29. Bow filler cushion (where equipped)
30. Battery or batteries
31. Amp board
32. Trash can door
33. Handheld fire extinguisher
34. Glove box
35. Observer remote (where equipped)
36. Center drain plug
37. Heated observer seat (where equipped)
38. Batteries ON-OFF switch
39. Tower with clamping board racks
40. Convertible center rear seating (where equipped)
41. Anchor light and tower tow point
42. Surf Star ballast bag (where equipped)
43. Automatic fire extinguisher
44. Transom drain plug
45. Swim platform

## SPECIFICATIONS

Length of Boat 20'0"

Width Amidship 98"

Boat Weight 4,500 lbs.

Length of Boat w/Platform 22'2"

Towing Length 28'6"

Towing Width 102"

Fuel Capacity 45 gallons

Maximum Capacity 11 people

or 1,600 lbs.

Bow Capacity: 4 people or 600 lbs.

Weight must be evenly distributed.

# XT20

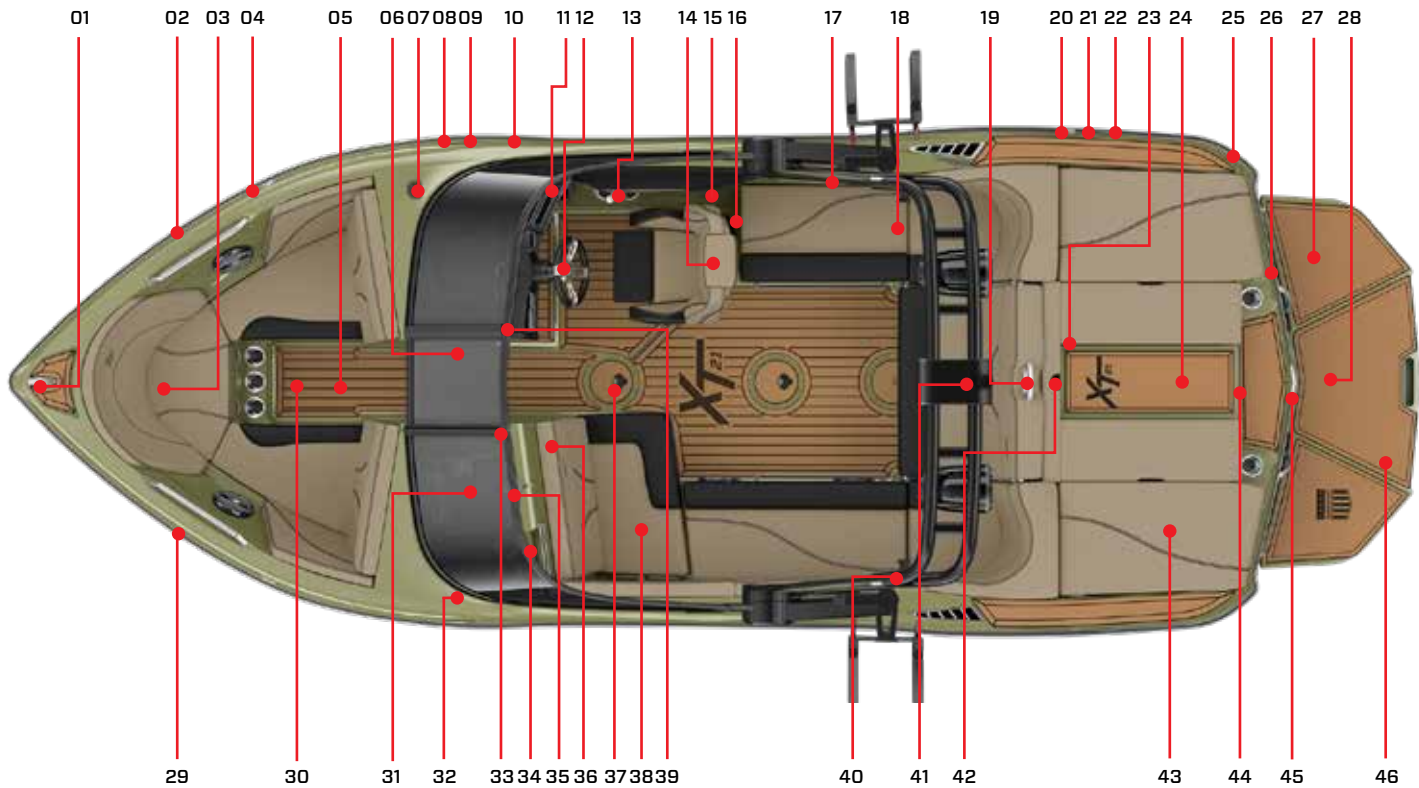

## FEATURES

01. Bow cleat
02. Navigation light
03. Anchor storage
04. Horn
05. Ballast tank (below deck)
06. Bow subwoofer
07. ZeroOff GPS puck
08. Ballast thru-hull outlet
09. Bilge thru-hull outlet
10. Midship cleat
11. Instrument panel
12. Steering wheel
13. Throttle control and emergency stop switch
14. Heated seat
15. Fire suppression unit manual override
16. Subwoofer (behind helm chair)
17. Wireless cockpit chargers (where equipped)
18. Cooler (under seat)
19. Convertible center rear seating (where equipped)
20. Ballast thru-hull outlet
21. Stern cleat
22. Fuel tank fill
23. Engine flush valve
24. Engine compartment
25. Bilge thru-hull outlet
26. Transom remote (where equipped)
27. Surf tab (beneath the platform; two on each side and one in the center)
28. Center surf tab
29. Horn
30. Bow filler cushion (where equipped)
31. Battery or batteries
32. Amp board
33. Trash can door
34. Handheld fire extinguisher
35. Glove box
36. Observer remote (where equipped)
37. Center drain plug
38. Heated observer seat (where equipped)
39. Batteries ON-OFF switch
40. Tower with clamping board racks
41. Anchor light; tower tow point
42. Ski pylon attachment point
43. Surf Star ballast bag (where equipped)
44. Automatic fire extinguisher
45. Transom drain plug
46. Swim platform

## SPECIFICATIONS

Length of Boat 21' 4"

Width Amidship 98"

Boat Weight 4,800 lbs.

Length of Boat w/Platform 23' 5"

Towing Length 26' 1"

Towing Width 102"

Fuel Capacity 51 gallons

Maximum Capacity 14 people

or 2,000 lbs.

Bow Capacity: 4 people or 600 lbs.

Weight must be evenly distributed.

# XT21

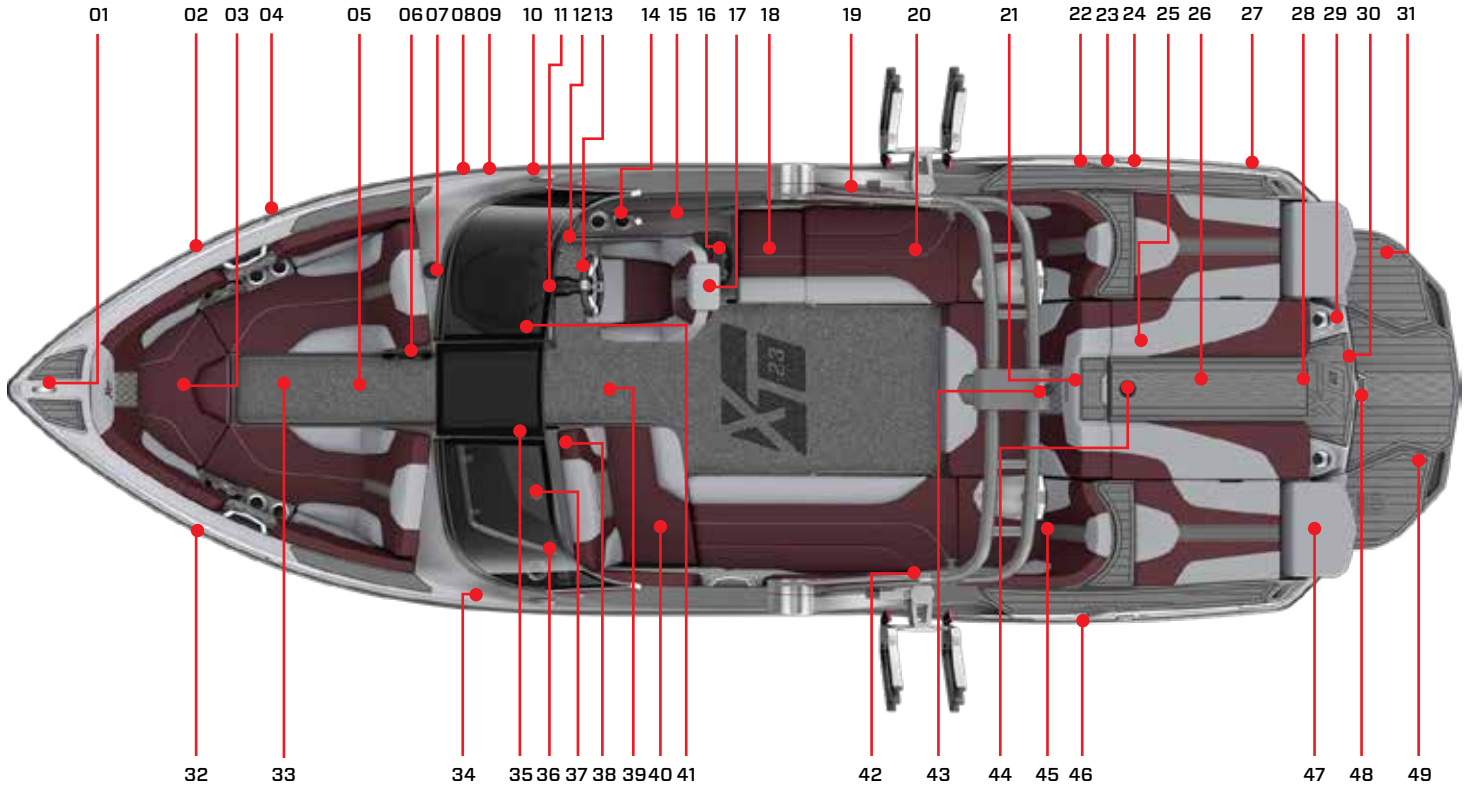

## FEATURES

01. Bow cleat
02. Horn
03. Anchor storage
04. Navigation light
05. Ballast tank below deck
06. Bow subwoofer
07. ZeroOff GPS puck
08. Bilge thru-hull outlet
09. Ballast thru-hull outlet
10. Midship cleat
11. Circuit breaker panel; battery switch
12. Instrument panel
13. Steering wheel
14. Throttle control and emergency stop switch
15. Fire suppression unit manual override
16. Subwoofer (where equipped)
17. Heated seat (where equipped)
18. Pop-up back-facing backrest
19. Wireless cockpit chargers (where equipped)
20. Cooler (under seat)
21. Convertible center rear seating (where equipped)
22. Ballast thru-hull outlet
23. Stern cleat
24. Fuel tank fill
25. Engine flush valve
26. Engine compartment
27. Bilge outlet
28. Automatic fire extinguisher
29. Transom remote (where equipped)
30. Underwater lights (two, where equipped)
31. Surf tab (two on either side and one in center)
32. Navigation light
33. Bow filler cushion (where equipped)
34. Amp
35. Trash can door
36. Handheld fire extinguisher
37. Glove box
38. Observer remote (where equipped)
39. Center drain plug
40. Heated observer seat (where equipped)
41. Batteries ON-OFF switch
42. Tower with clamping board racks
43. Anchor light and tower tow point attachment
44. Pylon attachment
45. Batteries (under seat)
46. Ballast thru-hull vents
47. Sun deck flip seating (where equipped)
48. Transom drain plug
49. Swim platform

## SPECIFICATIONS

Length of Boat 23'4"

Width Amidship 102"

Boat Weight 5,250 lbs.

Length of Boat w/Platform 25'4"

Towing Length 28' 3"

Towing Width 102"

Fuel Capacity 79 gallons

Maximum Capacity 16 people  
or 2,500 lbs.

Bow: 5 people or 750 lbs.

Weight must be evenly distributed.

# XT23

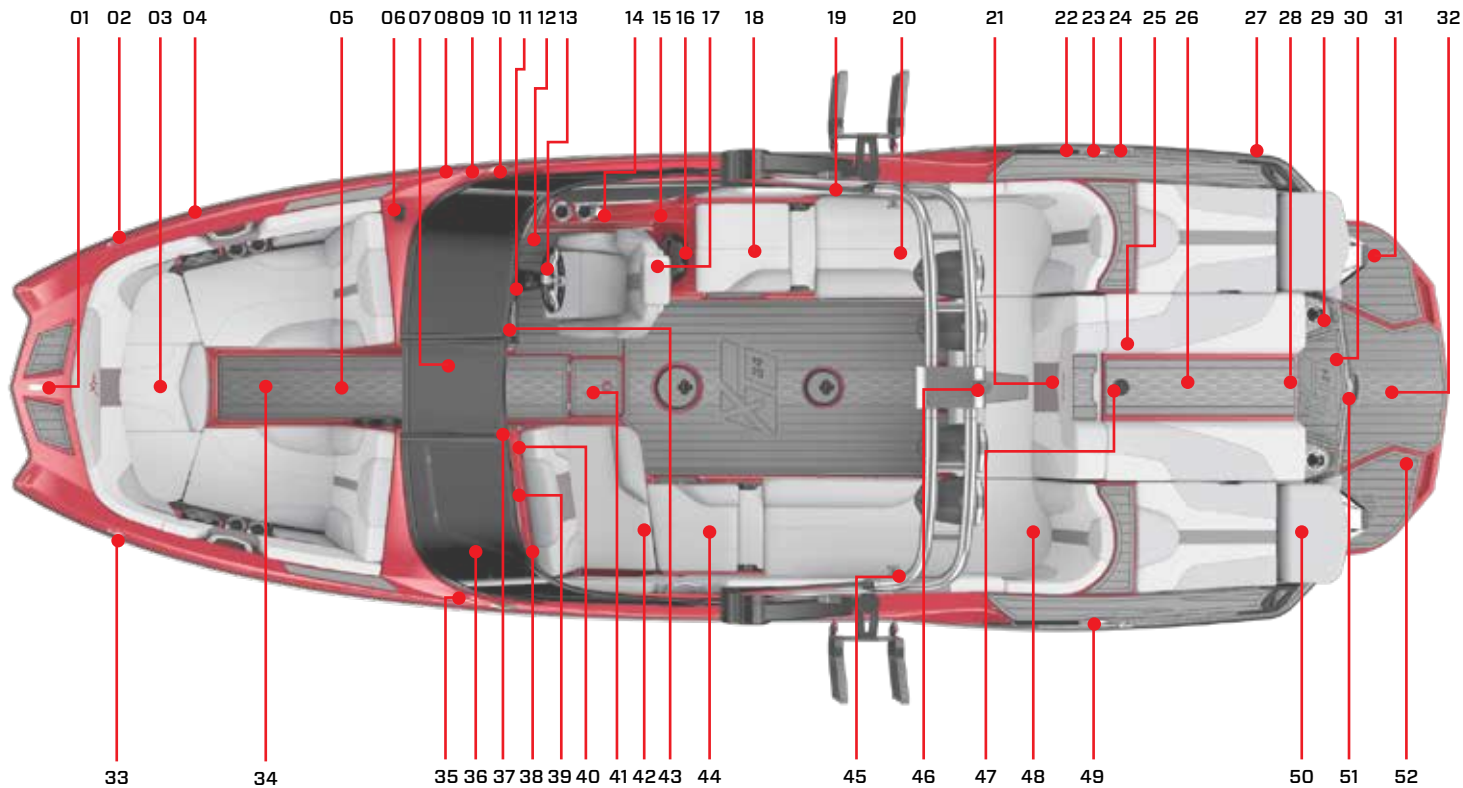

## FEATURES

01. Bow cleat
02. Navigation light
03. Anchor storage
04. Horn
05. Ballast tank below deck
06. ZeroOff GPS puck
07. Bow subwoofer
08. Bilge thru-hull
09. Ballast thru-hull vent
10. Midship cleat
11. Circuit breaker panel
12. Instrument panel
13. Steering wheel
14. Throttle control and emergency stop switch
15. Fire suppression unit manual override
16. Subwoofer (where equipped)
17. Heated seat
18. Pop up rear-facing backrest
19. Wireless cockpit chargers (where equipped)
20. Cooler (under seat)
21. Convertible center rear seating (where equipped)
22. Ballast thru-hull outlet
23. Stern cleat
24. Fuel tank fill
25. Engine flush valve
26. Engine compartment
27. Bilge thru-hull outlet
28. Automatic fire extinguisher
29. Transom remote (where equipped)
30. Underwater lights (two, where equipped)
31. Surf tab (one on each side and in center)
32. Center surf tab
33. Navigation light
34. Bow filler cushion (where equipped)
35. Amp
36. Bow subwoofer
37. Trash can door
38. Handheld fire extinguisher
39. Glove box
40. Observer remote (where equipped)
41. Center drain plug
42. Heated observer seat (where equipped)
43. Batteries ON-OFF switch
44. Pop up rear-facing backrest
45. Tower with clamping board racks
46. Anchor light and tower tow point attachment
47. Pylon attachment
48. Batteries (under seat)
49. Ballast thru-hull vents
50. Sun deck flip seating (where equipped)
51. Transom drain plug
52. Swim platform

## SPECIFICATIONS

Length of Boat 24' 0"

Width Amidship 102"

Boat Weight 5,550 lbs.

Length of Boat w/ Platform 26'

Towing Length 29' 11"

Towing Width 102"

Fuel Capacity 92 G

Maximum Capacity 17 people  
or 2,500 lbs.

Bow: 5 people or 750 lbs.

Weight must be evenly distributed.

# XT24

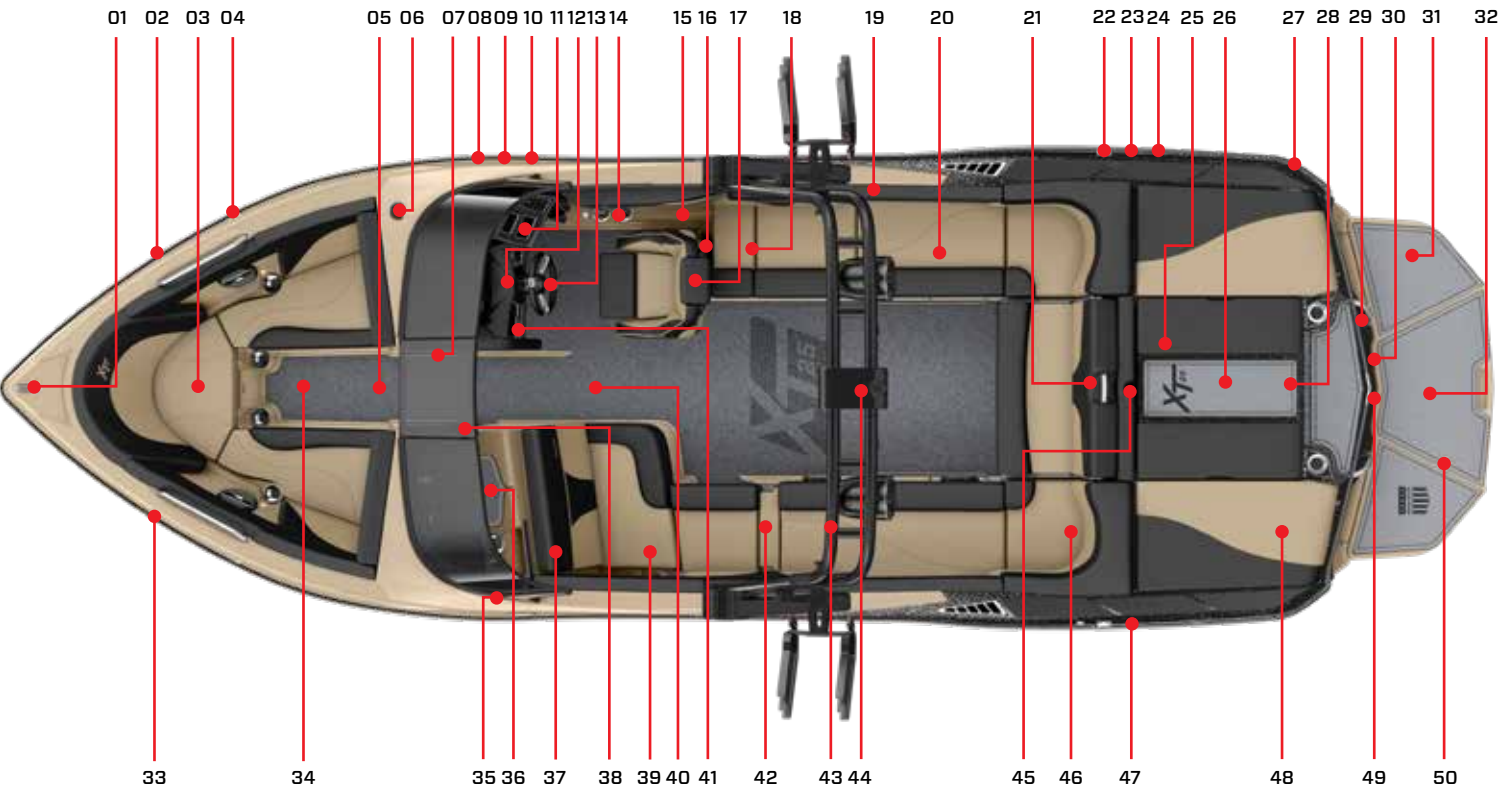



## FEATURES

01. Bow cleat
02. Navigation light
03. Anchor storage
04. Horn
05. Ballast tank below deck
06. ZeroOff GPS puck
07. Bow subwoofer
08. Ballast thru-hull vent
09. Bilge thru-hull vent
10. Midship cleat
11. Instrument panel
12. Main circuit breaker board
13. Steering wheel
14. Throttle control and emergency stop switch
15. Fire suppression unit manual override
16. Subwoofer (where equipped)
17. Heated seat (where equipped)
18. Pop up rear-facing seat
19. Wireless cockpit chargers (where equipped)
20. Cooler (under seat)
21. Convertible center rear seating (where equipped)
22. Ballast thru-hull vent
23. Stern cleat
24. Fuel tank fill
25. Engine flush valve
26. Engine compartment
27. Bilge vent
28. Automatic fire extinguisher
29. Transom remote (where equipped)
30. Underwater lights (two, where equipped)
31. Surf tab (one on each side and in center)
32. Center surf tab
33. Navigation light
34. Bow filler cushion (where equipped)
35. Amp
36. Glove box
37. Handheld fire extinguisher
38. Trash can door
39. Heated observer seat (where equipped)
40. Center drain plug
41. Batteries ON/OFF switch
42. Subwoofer (where equipped); flip up back-facing seat
43. Tower with clamping board racks
44. Anchor light and tow point
45. Ski pylon attachment
46. Batteries
47. Ballast thru-hull outlet
48. Sun deck flip seating (where equipped)
49. Transom drain plug
50. Swim platform

## SPECIFICATIONS

Length of Boat 25' 3"

Width Amidship 102"

Boat Weight 5,200 lbs.

Length of Boat w/Platform 27' 5"

Towing Length 30' 4"

Towing Width 102"

Fuel Capacity 92 gallons

Maximum Capacity 18 people  
or 2,500 lbs.

Bow: 5 people or 750 lbs.

Weight must be evenly distributed.

# XT25

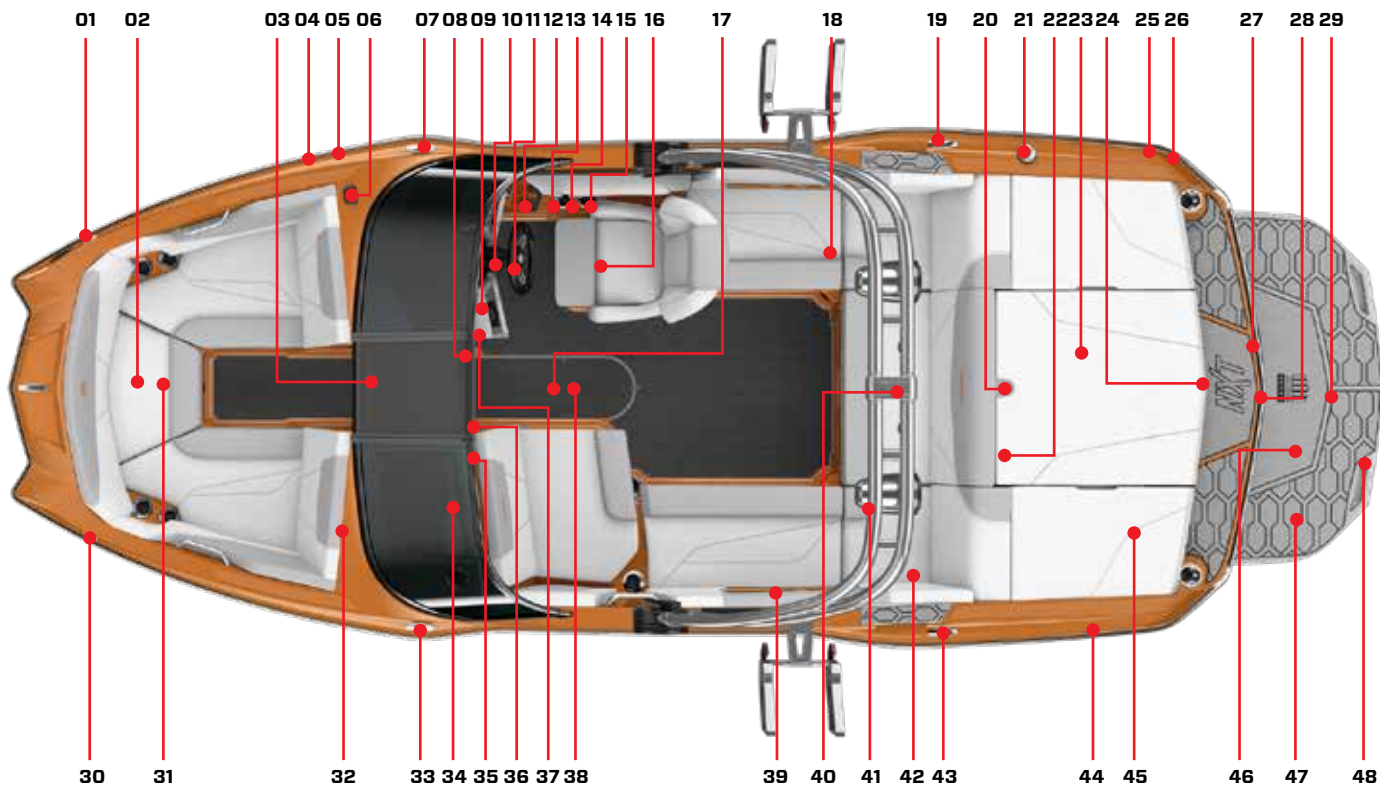

## FEATURES

01. Navigational light
02. Anchor storage compartment
03. Bow walk-thru door (where equipped)
04. Ballast thru-hull vents
05. Bilge thru-hull vents
06. ZeroOff GPS puck
07. Cleat (where equipped)
08. Mirror
09. Stereo control (on dash, where equipped)
10. Main circuit breaker board (beneath dash)
11. Steering wheel
12. Instrument panel; helm wireless charging pad (where equipped)
13. Shifter/throttle control
14. Emergency safety stop switch
15. Fire suppression unit manual override
16. Adjustable driver's seat
17. Access to center ballast pumps
18. Cooler (beneath seat)
19. Cleat (where equipped)
20. Ski pylon (where equipped)
21. Fuel tank fill
22. Sea strainer (in engine compartment)
23. Engine compartment
24. Automatic fire extinguisher (inside engine compartment)
25. Ballast thru-hull vent
26. Bilge thru-hull vent
27. Transom stereo remote (where equipped)
28. Transom drain plug
29. Center surf tab
30. Navigation light
31. Courtesy light
32. Amp
33. Cleat (where equipped)
34. Glove box
35. Subwoofer (where equipped)
36. Handheld fire extinguisher
37. Battery(ies) ON/OFF switch
38. Center drain plug
39. Wireless cockpit chargers (where equipped)
40. Tower tow rope attachment and light
41. Tower with clamping board racks
42. Battery/batteries
43. Cleat (where equipped)
44. Ballast thru-hull vent
45. Storage compartment; port tsunami pump
46. Engine exhaust (two exhaust tips; one on each side beneath the platform)
47. Surf tab (two devices; one on each side)
48. Swim platform

## SPECIFICATIONS

Length of Boat 20' 0"

Width Amidship 97"

Boat Weight 3,965 Lbs

Length of Boat w/Platform 22' 0"

Towing Length 25' 7"

Towing Width 102"

Fuel Capacity 47 G

Maximum Capacity 11 People or 1,804 lbs.

Bow: 4 people or 600 lbs.

Weight must be evenly distributed.

# NXT20

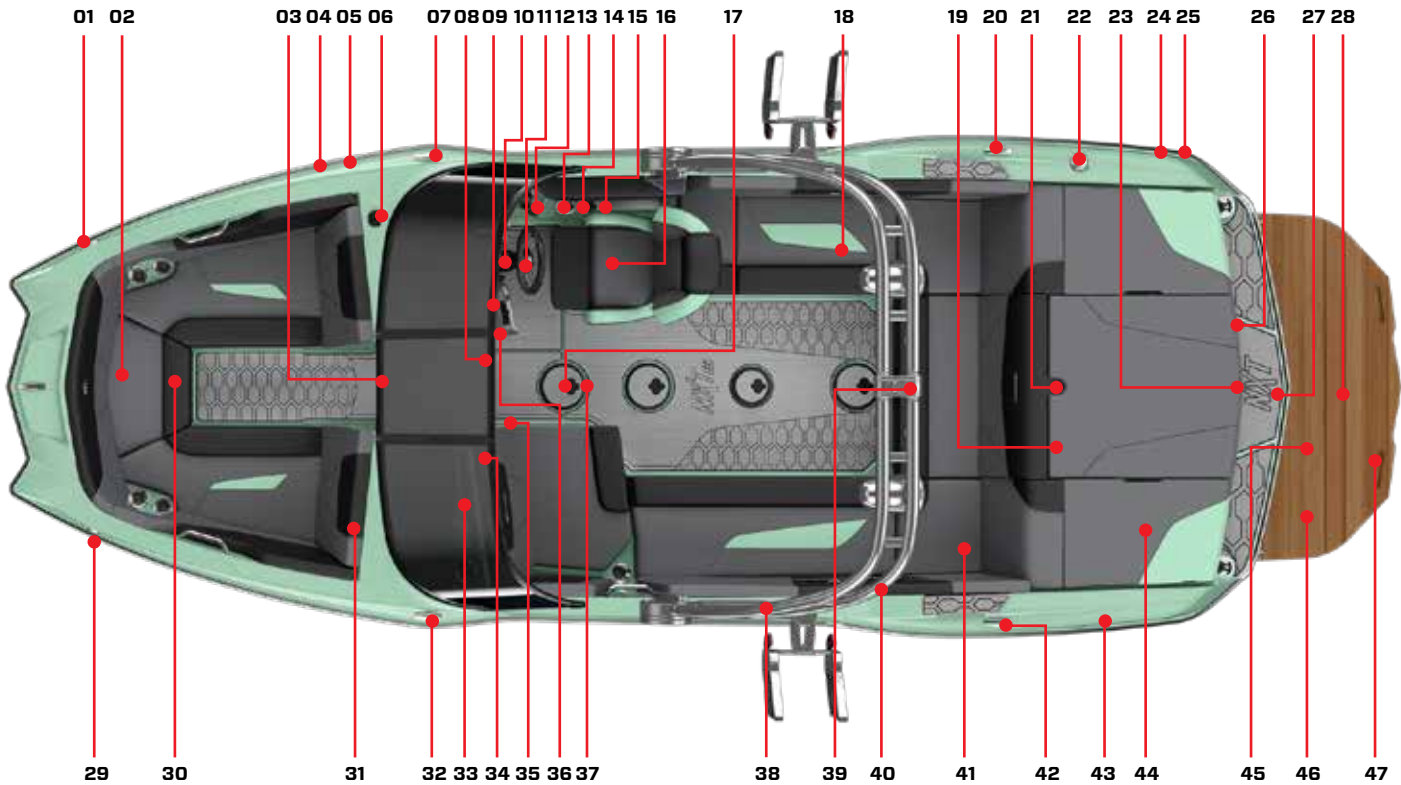

## FEATURES

01. Navigation light
02. Anchor storage compartment
03. Walk-thru door (where equipped)
04. Ballast thru-hull outlet
05. Bilge thru-hull outlet
06. ZeroOff GPS puck
07. Cleat (where equipped)
08. Mirror
09. Stereo control (on dash, where equipped)
10. Circuit breaker panel (access under dash)
11. Tilt steering wheel
12. Instrument panel; wireless helm charging pad (where equipped)
13. Shifter/throttle control
14. Emergency safety stop switch
15. Fire suppression unit manual override
16. Adjustable driver's seat
17. Access to center ballast pumps
18. Cooler (beneath seat)
19. Sea strainer (in engine compartment)
20. Cleat (where equipped)
21. Ski pylon (where equipped)
22. Fuel tank filler
23. Automatic fire extinguisher
24. Ballast thru-hull vent
25. Bilge thru-hull vent
26. Transom stereo remote (where equipped)
27. Transom drain plug
28. Center surf tab
29. Navigation light
30. Courtesy light
31. Amp
32. Cleat (where equipped)
33. Glove box
34. Hand-held fire extinguisher
35. Subwoofer (where equipped)
36. Battery ON/OFF switch
37. Center drain plug (accessible under carpet)
38. Tower with clamping board racks
39. Anchor light and tow point
40. Wireless chargers (where equipped)
41. Battery(ies)
42. Cleat (where equipped)
43. Ballast thru-hull outlet
44. Storage compartment + access to port side tsunami pump
45. Engine exhaust (two exhaust tips; one on each side beneath swim platform)
46. Surf tabs (two devices; one on each side)
47. Swim platform

## SPECIFICATIONS

Length of Boat 22' 0"

Width Amidship 99"

Boat Weight 4,213 lbs.

Length of Boat w/Platform 23' 10"

Towing Length 27' 4"

Towing Width 102"

Fuel Capacity 49 G

Maximum Capacity 14 people  
or 2,312 lbs.

Bow: 4 people or 600 lbs.

Weight must be evenly distributed.

# NXT22

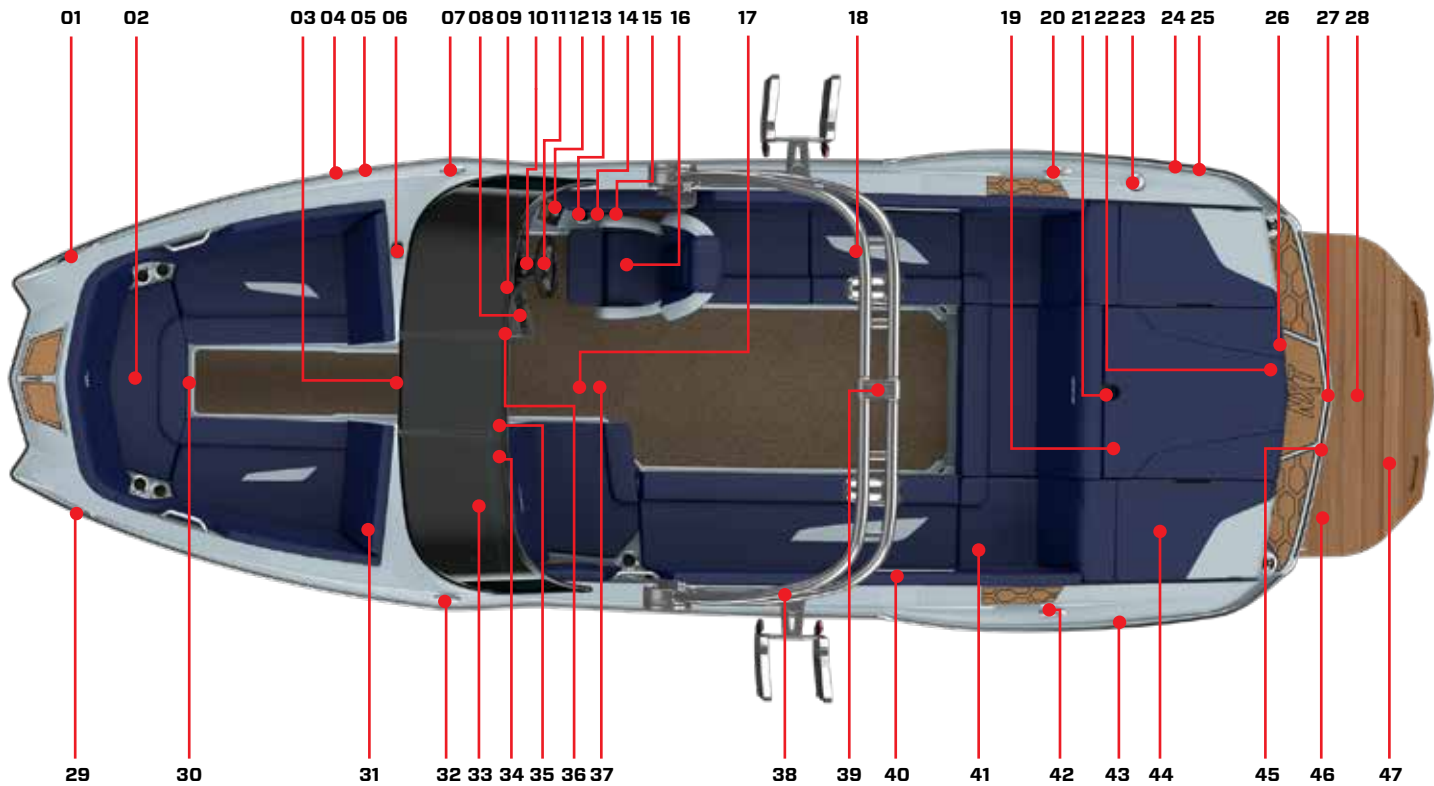

## FEATURES

01. Navigation light
02. Anchor storage compartment
03. Walk-thru door (where equipped)
04. Bilge thru-hull outlet
05. Ballast thru-hull outlets
06. ZeroOff GPS puck
07. Cleat (where equipped)
08. Stereo control (on dash, where equipped)
09. Mirror
10. Circuit breaker panel (access under dash)
11. Tilt steering wheel
12. Instrument panel; wireless helm charging pad (where equipped)
13. Shifter/throttle control
14. Emergency safety stop switch
15. Fire suppression unit manual override
16. Adjustable driver's seat
17. Access to center ballast pumps
18. Cooler (beneath seat)
19. Sea strainer (in engine compartment)
20. Cleat (where equipped)
21. Ski pylon attachment point
22. Automatic fire extinguisher (inside engine compartment)
23. Fuel tank filler
24. Ballast thru-hull outlet
25. Bilge thru-hull outlet
26. Transom stereo remote (where equipped)
27. Transom drain plug
28. Center surf tab
29. Navigation light
30. Courtesy light
31. Amp
32. Cleat
33. Glove box
34. Hand-held fire extinguisher
35. Subwoofer (where equipped)
36. Battery ON/OFF switch
37. Center drain plug (accessible under carpet)
38. Tower with clamping board racks
39. Tower tow rope attachment and light
40. Wireless cockpit chargers (where equipped)
41. Battery(ies)
42. Cleat (where equipped)
43. Ballast thru-hull vent
44. Storage compartment + access to port side tsunami pump
45. Engine exhaust (two exhaust tips; one on each side beneath swim platform)
46. Surf tabs (two devices; one on each side)
47. Swim platform

## SPECIFICATIONS

Length of Boat 24' 0"

Width Amidship 102"

Boat Weight 5,000 lbs.

Length of Boat w/Platform 26' 1"

Towing Length 29' 10"

Towing Width 102"

Fuel Capacity 65 G

Maximum Capacity 16 people  
or 2,250 lbs.

Bow: 5 people or 750 lbs.

Weight must be evenly distributed.

# NXT24

# **DASHES AND VIDEO SCREENS**





Immediately following this introduction are photo images of the five types of instrument panels utilized on MasterCraft boats. Operators should match up the appropriate image with the actual instrument panel on your boat.

The video screen operations are broken down into X and XT Series information, which utilize a standard 7" screen or the optional Dual Screen Dash, the ProStar, which uses a 7" screen, and the NXT, which uses a 4.5" screen. MasterCraft encourages all boat owners to go over the gauge and/or video screen operations with your authorized MasterCraft dealer prior to operating the boat.

 **DANGER**

**Do not become distracted while utilizing multi-functional screens. Maintain situational awareness and do not change settings in crowded boating/swimming areas.**

## VARIATIONS IN GAUGES AND SWITCHES

Please note that not every gauge or switch explained in this Owner's Manual is found on every model. Some equipment is optional, and not every option is available on all models of MasterCraft boats.

Also, MasterCraft utilizes a variety of gauge and switch styles that may be different from the gauges or switches pictured in this Owner's Manual. These differences between the various styles of gauges and switches are not in functionality. If a boat is equipped with a gauge or switch that is labeled as described, it will operate in the same fashion as the description, even if its appearance is different, as the appearance changes periodically.

If the owner and/or operators are uncertain about the purpose of a gauge or switch, do not operate the boat until consulting with an authorized MasterCraft dealer. Some gauges monitor information that is critical to safe and long-term use of the boat. Some switches can affect maneuverability, as well as operations that impact long-term use of the boat.

# MANUAL CONTROLS

Regardless of the dash option selected, a button pack to the right of the touchscreen acts as a manual control for tabs, ballast pumps, volume, navigation lights and anchor lights.



Component	Description
Volume	Increase or decrease the master volume level in the boat
Mute	Mute all audio zones, press again to un-mute all zones
Tab Controls	Press and hold UP or DOWN to increase or decrease the deployment of each of the three transom mounted tabs
Ballast Controls	Push once to fill or empty a ballast zone. Push again to pause ballast pump. When the tanks are filled to 100 percent, pressing the fill button again will turn on a 30 second over-fill. When the tanks are at 0 percent, pressing the empty button again will turn on a 30 second over-drain
Navigation Lights	Push once to turn the navigation lights on, push again to turn them off
Anchor Light	Push once to turn the anchor light on, used when the boat is anchored after dusk. Push a second time to turn them off

# X AND XT SERIES INSTRUMENT PANEL - DUAL SCREEN DASH



# X AND XT SERIES INSTRUMENT PANEL - 7" TOUCHSCREEN



# PROSTAR INSTRUMENT PANEL



# NXT SERIES INSTRUMENT PANEL



# X AND XT SERIES DUAL SCREEN DASH OPERATION

The X and XT Series Dual Screen Dash is designed for instrumentation and control on electronically controlled engines communicating via SAE J1939 and NMEA 2000. The multimedia displays provide cruise control and rider profiles, and enable boat operators to view many different engine, ballast, transmission parameters and service codes.





We continually strive to bring you the highest quality, full-featured products. As a result, you may find that your actual display screens may be slightly different than what is represented in this manual at the time of printing.

The Dual Screen Dash is designed for instrumentation and control on electronically controlled engines communicating via CAN networks. The Dual Screen Dash is made up of two screens, one 10.1" touchscreen (PV1100) and one 12.3" non-touch display (PV1200). The 12.3" PV1200 screen displays information based on the operating mode of the boat. The 10.1" PV1100 touchscreen is the command center for all of the boat's systems.

## CARE AND MAINTENANCE

General maintenance is not required; however, a soft cloth can be used for cleaning the units. Window cleaner or alcohol can also be used to clean the glass portion of the display. Do not use harsh or abrasive cleaners on the unit.

### CAUTION

**Avoid contact between sharp or hard objects and the video screens, as this can result in scratches or other permanent marks on the screen. Clean only with a soft cloth, using window cleaner or rubbing alcohol only. Never use harsh or abrasive cleaners on the unit, as this may result in damage to the unit that is not covered under warranty.**

## PV1200 OVERVIEW

The PV1200 unit displays gauges and other critical information. It features 2 display layouts: Standard and Wide Screen.

### Standard Screen:



### Wide Screen:



Located above the steering wheel on Dual Screen X and XT models, the PV1200 unit displays information relating to MPH, RPM, depth readings, temperature readings, battery charge, fuel levels, and

oil status. It has 2 display options (Standard/Wide) and 3 view modes (Media, Camera, and Navigation). These may be adjusted by selecting the  button on the PV1100 touchscreen.

Each view mode presents the user with different information. **Media View** presents the user with information regarding audio sources. **Camera View** displays live footage from the connected camera. **Navigation View** displays maps, waypoints, and tracking. To switch between views, press the  button on the touchscreen. For additional instructions, see pages 99-100 of this manual.

On X and XT models featuring Dual Screen Dash, the PV1200 acts as a substitute for a traditional speedometer and tachometer. This is not the case with Single Screen X/XT models, which have traditional engine gauges on their dashboards. For more information on traditional gauges, see pages 126-128 of this manual.

# PV1100 TOUCHSCREEN NAVIGATION AND OVERVIEW

Navigation within the PV1100 touchscreen is controlled via touch commands. The screen is divided into upper and lower halves. The upper half is controlled using the following selection panel:



## Operating Modes

The MasterCraft Dual Screen Dash is organized around three main on-water activities: driving from place-to-place, towing riders, and chilling. To correspond with these activities, the Dual Screen Dash features three primary operating modes: **Drive**, **Tow**, and **Chill**.

- **Drive Mode** displays basic operating information for cruising. From Drive Mode, you can quickly adjust speed, tabs, and ballast.
- **Tow Mode** is broken down into three modes: Surf, Wake, and Ski. Factory-loaded profiles for ballast, speed, and tab configurations are easy to select and modify when using Tow Mode. You may also use Tow Mode to create your own custom profiles.
- **Chill Mode** should be used when driving under 2 MPH or when stopped. It is intended for relaxation, and features stereo controls that make it easy to find and play your favorite music.

To switch between these modes, tap the buttons at the top of the touch display. Note that the operator cannot switch between modes while the throttle is in gear (forward or reverse).

# DRIVE MODE

Drive Mode displays basic operating information useful for cruising around your body of water. In Drive Mode, you may quickly fill or empty ballast, adjust tab positions, and activate speed control. Drive Mode is the default setting when the system first powers on.

## Upper Half of Drive Mode:



Component	Description
Drive (Normal Operations)	Drive Mode is optimized for cruising from place-to-place, with controls for AutoLaunch, speed, ballast, tabs, and cruise control
Surf Mode (Rapid and Custom)	Provides access to 7 preset surf profiles as well as custom profile creation. Also provides access to ballast, tabs, and cruise control.

Component	Description
Wake Mode	Provides access to custom and factory-made wake profiles, AutoLaunch controls, and ballast levels. Includes a custom profile creator.
Ski Mode	Provides access to custom and factory-made ski profiles, AutoLaunch controls, and ballast levels. Includes a custom profile creator.
Chill (Slow Speed Ops.)	Used when driving under 2 MPH or when stopped. Features expanded stereo controls.
Profile Selection and Creation	Available in Drive and Tow Modes. Provides the ability to create and select custom profiles.
Surf Tabs Adjustment	Provides access to individual surf tab controls
AutoLaunch Control (Triple and Single)	When AutoLaunch Single is turned on, the center tab helps push the boat up to plane. When AutoLaunch Triple is turned on, all three tabs help push the boat up to plane.
ZeroOff Controls	Activates or deactivates the speed control system. Enables adjustment of cruise control speed.
Fill/Empty All Ballast	Provides a quick method for filling or emptying all ballasts tanks/bags simultaneously
Volume Controls	Provides access to stereo volume controls

## Lower Half of Drive Mode:



Component	Description
PV1200 View Control	Adjust display settings for the PV1200 screen.
Maps and Navigation	View maps, adjust compass/bearings, set/manage waypoints, and record/manage tracks
Media	View maps, adjust compass/bearings, set/manage waypoints, and record/manage tracks
Volume/EQ	Access volume and EQ controls for the entire boat
Lights	Turn on and off the various standard and optional lighting sources on the boat
Accessory Switches	Enables control of various accessories, including heater, blower, bilges, and seat heaters
Main Menu/System Settings	<ul style="list-style-type: none"> <li>• System Settings</li> <li>• Bluetooth Manager</li> <li>• Spark Network Connections</li> <li>• Fuel Management</li> <li>• Diagnostics</li> <li>• Training Videos</li> <li>• GPS Settings</li> <li>• Ballast/Tab Settings</li> <li>• Service Information</li> <li>• Factory Settings</li> </ul>

# BALLAST

To fill the ballast tanks, touch either FILL (All Tanks) or tap in the ballast area to adjust individual ballast zones:

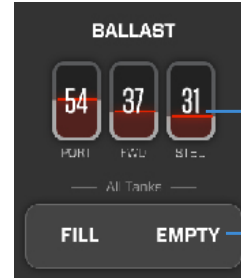

Individual tank settings. Tap to open the dedicated ballast adjustment screen.

Fill or empty all tanks completely

Tapping the ballast zone area will pull up the following screen:



From the ballast screen, users can fill or empty all ballast zones by touching FILL or EMPTY ALL. To pause the fill process, tap STOP ALL. To adjust individual ballast zones, touch the UP or DOWN arrows at the top or bottom of the ballast zone that you wish to fill or empty. Alternatively, slide your finger along the ballast progress bars to adjust ballast zones and set custom fill levels.

## ADJUSTING TABS

Tabs allow you to precisely dial in your wakes and waves by sculpting the water as it leaves the hull bottom. Touch the surf tab area to adjust individual tabs.

**Touching the surf tab area will pull up the following screen.** Make adjustments to each tab by touching the up and down arrows. Alternatively, slide your finger up or down the slider bar.



Touching this area will open the surf tab adjustment screen



## BALLAST AND TAB SETTINGS

From Main Menu/System Settings, you may access Ballast/Tabs Settings. This screen allows you to establish fill and drain times for each ballast zone, along with times for center and surf tab crossover. MasterCraft does not recommend adjusting fill times, as these timers are factory-set. If you feel the need to change timer settings, contact your authorized MasterCraft dealer.

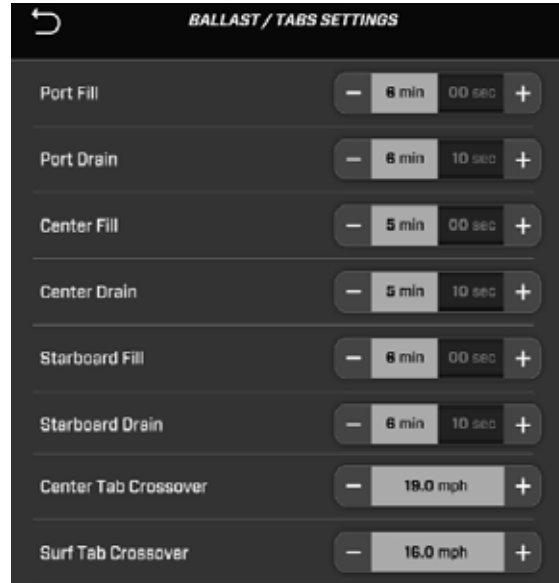

## AutoLaunch Crossover Settings

AutoLaunch is the logic software that automatically deploys and retracts surf tabs in order to get the boat on plane. When enabled, AutoLaunch will automatically deploy one or all three of the surf tabs, pushing the boat up to plane at a faster rate. Once the boat no longer needs assistance getting on plane, the tabs will automatically retract to normal running position.

The boat has reached its “crossover speed” when it no longer requires any assistance getting on plane. Crossover speed is pre-configured on all MasterCraft boats. While you can adjust crossover speed from the “Ballast and Tab Settings” menu, you should only do so if the boat’s normal operating weight is either very light or very heavy. In such cases, crossover speed may be decreased for lighter loads and increased for heavier loads.

If you are consistently running the boat without ballast or with just a few people onboard, you may wish to decrease the crossover speed. To decrease the crossover speed for a particular surf tab, access the crossover settings found within the “Ballast and Tab Settings” menu. Then tap the DOWN arrow beside the tab. If you have a very heavy operating load, you can increase the crossover speed by pressing the UP arrow beside the tab.

## CRUISING

The dual screen dash simplifies cruising to and from the best riding spot on the lake by allowing operators to easily get the boat’s ballast and tabs settings prepared for a set.

### Heading Out:

To prepare the boat for a riding session on the way to your favorite spot, navigate to Drive Mode. The boat will default to 28 MPH and AutoLaunch Single will default ON. If necessary use AutoLaunch Triple. Tap FILL ALL to start filling the ballast tanks.

### Heading Home:

At the end of the day when it is time to empty the ballast tanks and head home, navigate to Drive Mode. AutoLaunch Single will default ON and speed control will default to 28 MPH. Tap EMPTY ALL to drain the ballast tanks. If necessary turn AutoLaunch Triple ON to assist the boat to plane. Navigating to Drive Mode will always cancel any active Tow Mode profiles, but will not drain the ballast tanks.



# TOW MODE

## Surf Mode: Overview

Surf Mode is divided into 2 distinct menus: Rapid Surf and Custom Surf. From the Rapid Surf menu, you may choose the shape of your wave by selecting 1 of 7 different wave presets. Use the controls provided on the lefthand side of the screen to easily select a preset. Doing so will modify the steepness of your wave.



When Surf Mode is first selected, Rapid Surf is the default menu setting. To toggle between Rapid Surf and Custom Surf, use the button located in the top righthand corner of the screen. Custom

Surf provides additional options for seasoned athletes, such as tab and ballast control. For more information on Rapid Surf and Custom Surf operation, refer to the dedicated sections below.

## Rapid Surf

Rapid Surf is one of two menus included within Surf Mode. It allows you to easily select a wave using the slider on the lefthand side of the screen. Alternatively, you may use the arrows located immediately to the right of the slider. Hitting the “Up” arrow or raising the slider will create a steeper wave. Hitting the “Down” arrow or lowering the slider will create a mellower wave.

From the Rapid Surf menu, you may also choose the position of your surf wave. Selecting SURF RIGHT will create a starboard wave. Selecting SURF LEFT will create a port-side wave.

Any adjustments made to your surf wave will appear on the wave graphic to the right of the wave adjustment controls. This window includes a readiness timer that serves to calculate and display the amount of time needed for the wave to generate. Whenever new adjustments are made, a flashing yellow light and loading bar will indicate the amount of time needed to build the wave.

In addition to wave adjustment settings, Rapid Surf includes options for storing wave presets and creating custom surf profiles. For more information on wave presets and custom profile creation, refer to the section titled “Creating a New Surf Profile.”



## Using Rapid Surf to Select a Wave

Rapid Surf is intended to make wave customization a quick and easy process. In a few simple steps, you can build an amazing surf wave and hit the water in no time.

1. Before you begin setting up your wave, make sure that Surf Mode is selected and that it is set to the Rapid Surf menu. When Rapid Surf is active, the following screen will appear:



2. Locate the slider and arrows found on the left-hand side of the screen. These controls allow you to choose from 7 Naval Preset Profiles. Each Naval Preset has been designed to suit a particular surf style. 1 is the mellowest, shortest wave and is suited to beginners. 7 is the steepest, tallest wave and is suited to advanced surfers. The average surfer will most likely opt for presets 3-5. **Note:** For each of the 7 Naval Presets, there is a SURF LEFT and SURF RIGHT variant. As a result, the operator has 14 Naval Presets to choose from in total.

3. Use your finger to drag the slider to the desired wave preset. Alternatively, use the arrows to the right of the slider.



4. Using the SURF LEFT/SURF RIGHT buttons, choose the position of your surf wave. Selecting SURF LEFT will direct the surf tabs to create a port-side wave. Selecting SURF RIGHT will direct the surf tabs to create a starboard wave.
5. If you are satisfied with your wave and wish to save it as a preset for later use, you may do so using the slot bar near the bottom of the screen. This bar houses 6 slots in total. To store your wave in one of these slots, press and hold any EMPTY slot.

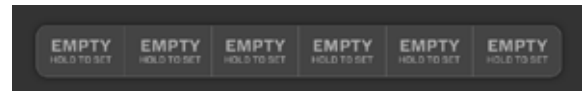

## Custom Surf

Custom Surf provides access to additional, in-depth wave settings. From this menu, you may adjust ballast fill levels, tab positions, wave position, and ZeroOff cruise control. You may also store presets, create custom profiles, manage/select profiles, and adjust sound settings. With its deep customization features, this menu is designed for experienced wakesurfing enthusiasts looking to craft a wave that perfectly suits their unique preferences.



To access the Custom Surf menu, select CUSTOM SURF from the toggle in the top righthand corner of the Surf Mode screen.

## Creating a New Surf Profile

Both Rapid Surf and Custom Surf allow you to create your own custom surf profile with individualized tab, ballast, and speed settings. The profile may then be stored for later use. To create a custom surf profile, follow the instructions below.

1. Select  from the panel near the top of the screen.
2. The following menu will appear onscreen. From this menu, you may adjust ballast fill levels, tab deployment, speed, and cruise control (on/off). You may also tap SURF LEFT or SURF RIGHT to set the wave position. (Tapping a ballast zone or surf tab will take you to a dedicated ballast or tab adjustment screen.)



3. When you are satisfied with your settings, touch the NEXT button. Doing so will save the adjustments to your profile and take you to the next step in the profile creation process.



- Using the keyboard provided, give your profile a name.



- Tap **SAVE & ACTIVATE** if you want to save and immediately activate your new profile. Tap **SAVE & CLOSE** if you want to save the profile for later use. Saved profiles can be accessed at any time by using the profile manager.

## Using the Profile Manager

Once a profile has been created, you can access it using the profile manager. This menu allows you to select, edit, or delete custom profiles. It may hold up to 30 profiles at a time.

- Select  from the panel near the top of the screen.
- The profile manager will appear onscreen. Using the profile manager, you may select any custom profile from the dropdown menu on the righthand side of the screen. You may also edit or delete custom profiles by tapping  or .

- To activate a profile, first use the dropdown menu to find it.



- Tap the profile to select it.
- Once the profile is selected, touch the **ACTIVATE** button. Doing so will immediately activate the profile.
- When you no longer wish to use the profile, select it again and touch the **DEACTIVATE** button.

## Wake Mode

Wake Mode is intended solely for wakeboarding. Like Surf Mode, it enables control of surf tabs and ballast zones, allowing the user to influence the shape and intensity of the wake generated by the boat's WSDs. Wake Mode includes 3 stock wake profiles: **Beginner**, **Intermediate**, and **Advanced**. MasterCraft recommends that you select the profile corresponding to your level of ability.



- **Beginner** - Designed for new riders who are still learning to wakeboard. Allows the user to get comfortable wakeboarding at slower speeds. The user may begin learning surface tricks and wake crossings. Recommended line length: 55-60'.
- **Intermediate** - Designed for moderately experienced riders learning their first wake-to-wake jumps, basic inverts, and spins. Recommended line length: 55-65'.
- **Advanced** - Designed for highly experienced riders seeking bigger airs for advanced tricks. Recommended line length: 65-75'.

All 3 stock profiles are accessible from the Wake Mode home screen. To activate a stock profile, tap the one you wish to use. The button will turn light gray, indicating that the profile is active.

## Custom Wake Profiles

In addition to letting the user select a stock profile, Wake Mode also allows for the creation of custom wakeboard profiles. Once created, these profiles can be saved and stored for use at any time. To build a profile, complete the following series of steps.

1. Select  from the panel near the top of the menu. The following screen will appear. From this screen, you may adjust and set tab, ballast, and cruise control settings. Selecting an individual tab or ballast zone will take you to a dedicated tab/ballast page.



2. When you are satisfied with your settings, touch the NEXT button. Doing so will save any adjustments made to your profile and take you to the next step in the profile creation process.

- Using the keyboard provided, give your profile a name.



- Tap SAVE & ACTIVATE if you want to save and immediately activate your new profile. Tap SAVE & CLOSE to save the profile for later use. Saved profiles can be accessed at any time using the profile manager, pictured below.



## Ski Mode

Ski Mode is intended solely for skiing. Like the other tow mode variants, it includes options for adjusting tabs, ballast, and cruise control. MasterCraft has one predefined ski profile: **Ski**. To activate this profile, tap the SKI button under the ZeroOff button.



## Custom Ski Profiles

To create a custom ski profile, follow these steps:

- Select . Adjust and set tabs, ballast, and cruise control.
- When you are done, touch the NEXT button.
- Using the keyboard provided, give your profile a name.
- Tap SAVE & ACTIVATE to save and activate your new profile. Tap SAVE & CLOSE to save the profile for later use.

# CHILL MODE

Intended for low-speed travel and relaxation, Chill Mode provides access to additional stereo controls. Use this mode to play your favorite music when you and your passengers are looking to kick back. Note that Chill Mode can only be accessed when the boat is stopped, in neutral, or traveling less than 2 MPH.

## Upper Screen Half:

When Chill Mode is enabled, the upper half of the screen will display stereo controls. You may use these controls to select an audio source, adjust output volume, or choose a radio station (if WB, AM, or FM are selected). For more information on stereo controls, refer to the “Media” section appearing later in this chapter.



## Lower Screen Half:

When Chill Mode is enabled, the lower half of the screen will display the Menu Bar. Use the Menu Bar to access gauge display, maps and navigation, media, lights, accessory switches, and settings.



Each tab/page in the Menu Bar has a specific function and method of operation. For detailed information on the Menu Bar and the various pages it allows the operator to access, please refer to the “Menu Bar” section featured later in this chapter.

Component	Description
Maps	Provides access to Navigation. Users can display and record tracks and waypoints.
Media	Provides access to AM/FM/Weather bands, Bluetooth and USB media selections.
Volume/Equalizer	Access to volume zone and equalizer controls for the entire boat.
Lights	Turn on/off the standard and optional lighting on the boat.
Switches	Controls for various accessories including the bilge, heater, seat heaters and blower switches.
Main Menu/Settings	<ul style="list-style-type: none"> <li>• System Settings</li> <li>• Bluetooth Manager</li> <li>• Fuel Management</li> <li>• Diagnostics</li> <li>• GPS Settings</li> <li>• Ballast / Tab Settings</li> <li>• Service Information</li> <li>• Factory Settings</li> </ul>



# MENU BAR

The Menu Bar can be accessed in all three operating modes: Drive, Tow, and Chill. Using the buttons on the Menu Bar, the operator may access controls affecting PV1200, navigation, media, volume/EQ, lighting, accessory switches, and system settings.

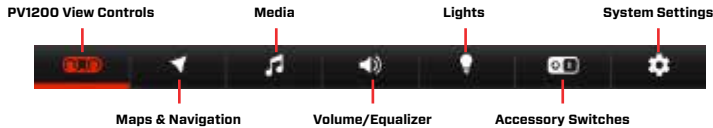

# PV1200 VIEW CONTROLS

The PV1200 View Control Page is used to alter the view mode and visual display of the PV1200 screen that sits above the wheel. From this page, you may switch between 3 view modes (Media, Camera, and Navigation) and 2 display layouts (Standard and Wide). To access this page, select from the Menu Bar.

Use this page to adjust what kind of information is displayed on the PV1200 screen. Selecting will display media information. Selecting will display footage from connected camera devices. Selecting will display helpful GPS navigation data, such as maps, waypoints, and tracking information. (For more information on maps and nav, see “Maps and Navigation” below.)

You may also use this page to modify display layout. Selecting will set the PV1200 to Wide Screen Display. As long as this option is enabled, the tachometer (RPM) and speedometer (MPH) will be visible on the right and left sides of the PV1200 screen.

Selecting will set the PV1200 to Standard Screen Display. While this option is selected, the PV1200 will display air/water temperatures and depth readings on the right and left sides of the screen. Your chosen View Mode setting will not be affected by switching between Standard and Wide Screen Display.

## Standard Screen Enabled:

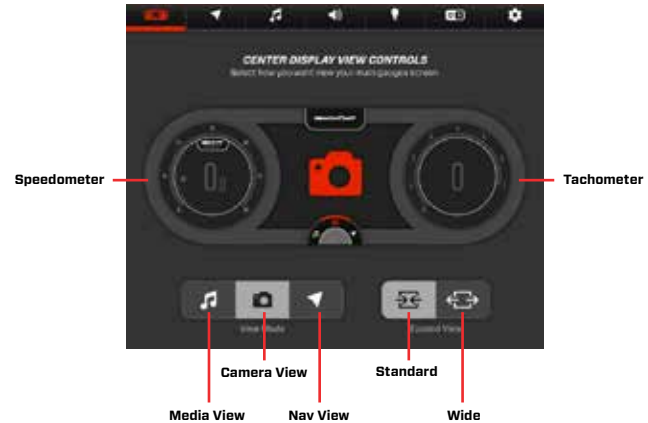



## Wide Screen Enabled:

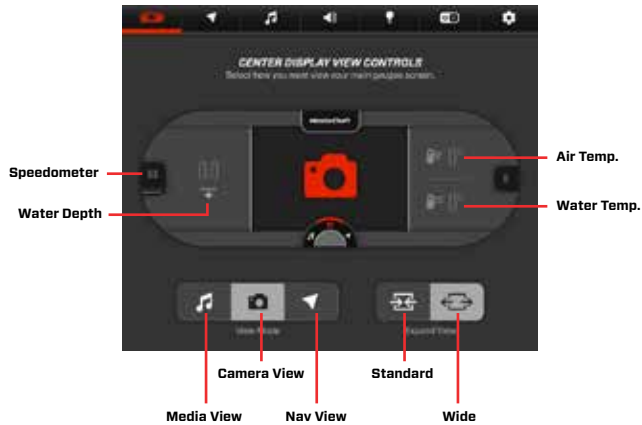





# MAPS AND NAVIGATION





From the Maps and Navigation Page, you can view your GPS location, enable tracking, and create/manage waypoints. To access this page, select  from the Menu Bar. A map will appear onscreen with options for tracking and waypoint management.

Navigational information can also be found on the PV1200 gauge screen located above the steering wheel. (Refer to the “PV1200 View Controls” section immediately preceding this one.)







When the Maps & Navigation Page is selected from the Menu Bar, a map display will appear onscreen:





From this page, you can manage waypoints and tracking options. Select  to add a waypoint and  to adjust waypoints. To enable tracking, tap the  button. The system will begin recording your tracking data for later use. To stop recording a track, tap the button again and the system will stop recording. You can access previously recorded tracks and tracking settings by touching .

Use the  and  buttons to zoom in/out. Select  to center the map. Select  to toggle between north up/course up.

The following table breaks down the name and function of each button found on the Maps & Navigation Page.

Component	Description
	Allows user to zoom in and out of a particular spot on the map.
	Edit existing track names; alter track color; select tracks. Show or hide existing tracks and delete tracks, either one at a time or all at once.
	Touch this button at the start of a track, and touch it again at the end of the track to record it.
	Drop a waypoint (saved location) on the map. A keyboard appears to name the waypoint. Select the type of waypoint (flag, anchor, fish and marina).
	View and/or go to a specific waypoint, edit a waypoint name, assign waypoint icons and delete one or all waypoints.
	Orients the display of the map to be either North at the top, or the course heading at the top.

# MEDIA

The Media Page allows you to easily adjust audio sources and output volume. Additionally, if FM, AM, or WB audio sources are selected, you may adjust tuning frequency and switch between channels. You may also select and save up to 5 preset radio stations. To access the Media Page, select . You may select an audio source by touching .



## FM/AM Radio

When FM/AM audio sources are selected, you may change stations, scan for stations, adjust output volume, and save presets.



To switch between stations, touch or . Touching or will scan for detectable signals. If you have a favorite station and wish to save it as a preset, touch and hold . Mute or unmute volume using . Set volume using the volume slider.

## Weather Band

When WB (Weather Band) is selected as the audio source, you may choose 1 of 7 National Weather Service channels in order to obtain regional weather information. To select an NWS channel, use the tuning arrows or pick a station from the channel list.



Volume controls for Weather Band audio sources are identical to those used for FM and AM sources, detailed above.

The following table breaks down the name and function of each button found on the Media Page.

Component	Description
and	AM/FM: Scan to previous or next detectable signal. WB: Tune to next channel. USB: Next track.
and	Fine tune the current station
	Save a favorite station. Tune into the station, then press and hold the slot for approximately 3 seconds.
	Volume adjustment. Touch and drag the slider to adjust volume.
	Mutes and unmutes volume

## USB and Bluetooth Audio Connections

Connecting a phone or MP3 player via USB and Bluetooth allows your personal music collection or an online music service like Spotify or Pandora to be played through the boat's audio system. Bluetooth and USB connections each have their benefits, but to take full advantage of all that the boat has to offer, MasterCraft recommends connecting both via Bluetooth and USB cable.

Connecting via USB cable offers the best audio quality, displayed album art and song information, faster timing, charging and full control over the playlists and menus on select Apple devices. Connecting via Bluetooth gives operators wireless audio, phone call and text notifications, pre-written text message quick responses (Select Android devices), displayed album art and song information.

### To Connect via Bluetooth:

1. Ensure that your device's Bluetooth is turned on.
2. On the PV1100 touchscreen navigate to the Bluetooth Manager on the Settings Menu. All discoverable Bluetooth devices will appear. If you have not connected the new device with the boat before, touch "+Add New Device" to connect the device.
3. The screen will display ADD NEW DEVICE. Tap OK, then ensure that your device's Bluetooth connection is ON and that your phone is visible to new devices.
4. The MasterCraft unit will begin to search for your device. Once the boat has discovered your device, tap your device's name and a message will display stating "Confirm Pairing on Your Phone."

5. On your phone, a Bluetooth Pairing Request will appear. Touch OK. The MasterCraft unit will display the connected device to the left side of the screen and song information and controls on the right side of the screen.

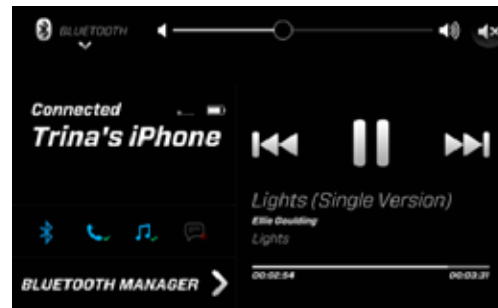

### To Connect via USB Cable:

1. Plug the phone's charging cord into the USB port mounted under the throttle control.

2. Your phone will begin charging and will be connected to the boat.
3. Navigate to, and select the USB symbol on the stereo source list to get access to your phone's music collection. Launch a music application on your phone and it will display on the screen (Apple devices only, Android devices can only play music that has been downloaded to the device's internal memory).

## BLUETOOTH SETTINGS

Connecting via Bluetooth allows operators to connect to the boat wirelessly, play audio, receive phone calls and text notifications, send pre-written text message quick responses (Android only), and display album art and song information. To customize Bluetooth settings, navigate to the settings tab and select BLUETOOTH MANAGER. From here you can pair other Bluetooth devices and change active devices. Tap into BLUETOOTH SETTINGS to customize call and text notifications.

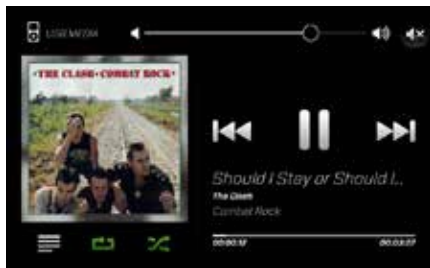

## Enabling Phone Notifications

1. To receive call or text message notifications on the dual screen dash, navigate to **BLUETOOTH MANAGER** and tap the **BLUETOOTH SETTINGS** button. Tap **ENABLED** next to either Call Notifications or Text Notifications to allow the screen to display phone call and text message notifications.

**NOTE:** Apple devices are not compatible with Quick Text Replies.

**NOTE:** Phone notifications must be enabled in your device's settings menu to receive alerts on the dual screen dash.

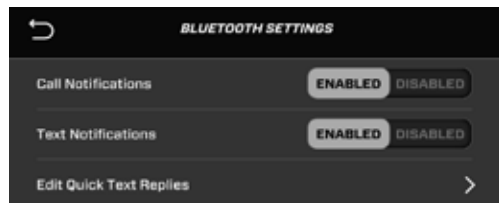

To reply to a text message that appears on the screen tap the QUICK TEXT REPLY button and choose a pre-written text response from the list.

## Editing Quick-Reply Messages

Quick Text Replies can be edited by touching EDIT QUICK TEXT REPLIES on the settings menu. Tap the pencil icon to the right of the reply you wish to edit. This will pull up a keyboard where the message can be edited.

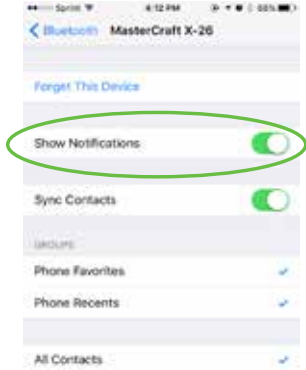

Apple Device

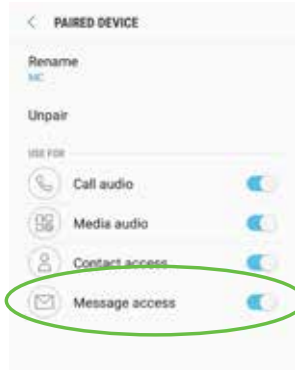

Android Device

# VOLUME / EQUALIZER

## Volume Zones

From the Volume/Equalizer Page, you may control the volume and frequency ranges of all onboard speakers. You may adjust master volume (combined output of all speakers) as well as 5 individual speaker zones: Bow, Sub, Helm, Cockpit, and Tower.

Speaker zone volumes reflect a percentage of the master volume. If the master volume is set to 20% and a zone is set to 40%, the zone is playing at 100% of the current master volume. If the master is adjusted to 30%, the zone will become louder while continuing to play at 100% of the master volume. To play the speakers at maximum volume, turn all of the zones up to their maximum volume level, then do the same with the master volume.

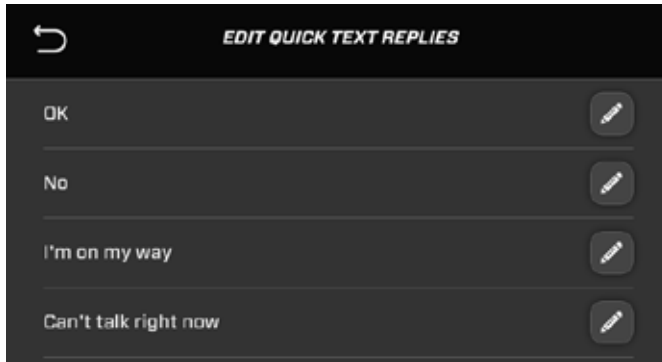

You can mute a zone by selecting it and tapping . To mute all zones, deselect them and tap .

#### To change the volume of a zone:

1. Touch the zone you wish to adjust.
2. Slide your finger along the slider below the zone selection area until you reach the desired volume.

## Auto Volume

The auto volume feature automatically adjusts master volume to compensate for the noise generated by increased boat speeds. To modify auto volume, hit the “Auto Vol.” tab and choose from 1 of 5 auto volume levels. 1 is the least aggressive setting; 5 is the most aggressive. To deactivate auto volume, select OFF.

## Equalizer (EQ)



The EQ allows you to adjust the balance of bass, mid, and treble frequencies. Use the sliders to modify frequency ranges.

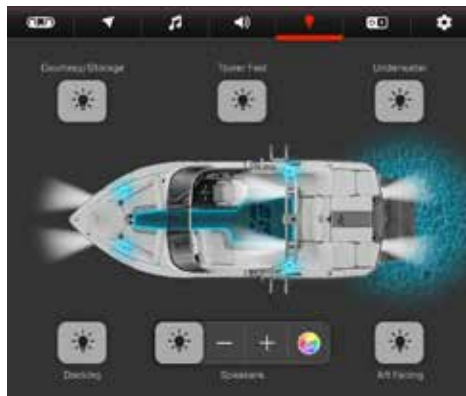

# LIGHTING

To turn lights ON or OFF for a specific zone, touch the  button corresponding to that zone.



You may adjust the intensity of the speaker lights by touching the  and  buttons. Additionally, you may change the color of the lights by touching . After moving the slider to the desired color and intensity, touch DONE:



# ACCESSORY SWITCHES

The Accessory Switches Page allows you to activate or deactivate the blower, cockpit heater, bilge pumps, and seat heaters. To activate a device, tap the corresponding button. It will be highlighted in gray, and a representative graphic will appear onscreen.

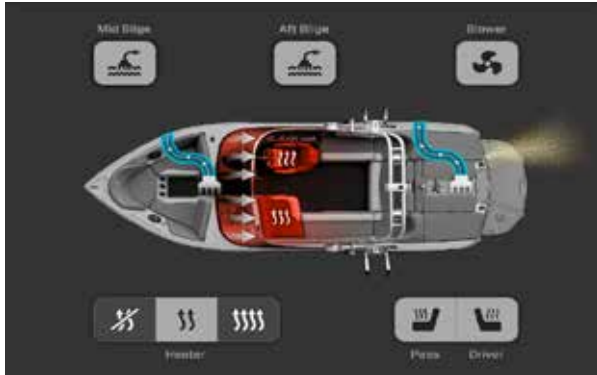

Please note: When the ignition key is turned to the “on” position, the blower will automatically activate and run for exactly four (4) minutes. If you would like to turn the blower on manually, you may do so from the Accessory Switches Page.

# MAIN MENU

From the Main Menu, you can access and adjust System Settings, PDM Diagnostics, Fuel Management, Bluetooth Manager, Bluetooth Management, GPS Settings, Software Updates, Service Information, Factory Settings, and Tab/Ballast Settings. You can also view training videos on boat operations.



# SYSTEM SETTINGS

From the System Settings Page, you can easily adjust major settings, including system of measurement (standard or metric), fuel management, depth alarms, and brightness.





The following table breaks down the name and function of each button found on the System Settings page:

Component	Description
Units	Choose a measurement system: Metric or U.S. Standard. Your choice will impact depth, fuel volume, and speed measurements.
Fire Extinguisher Pop-up	A pop-up display indicating when the engine compartment's fire extinguisher is active or has been activated.
Fuel Management	When enabled, fuel management calculates fuel levels based on engine activity and RPM.
Fuel Alarm	An alarm indicating when fuel levels have reached the saved percentage amount.
Minimum Depth Alarm	An alarm indicating when the established minimum depth has been detected. This can be adjusted in increments of 6 inches.
Brightness: Day	Adjust screen brightness during daylight hours. Slide to adjust brightness levels.
Brightness: Night	Adjust screen brightness during daylight hours. Slide to adjust brightness levels.
Tuner Region	Select your location so that the AM/FM radio may optimize stations geographically.
Update Software	Allows your authorized MasterCraft dealer to download PV1100 software updates.

## BLUETOOTH MANAGER

See the “Bluetooth Settings” section of this chapter.

## SPARK NETWORK CONNECTION

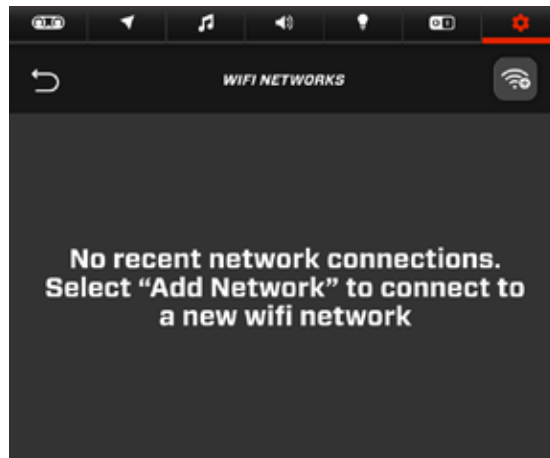

Your authorized dealer may follow these steps to connect to a wi-fi network and download new PV1100 software updates.

To begin the process, select “Spark Network Connection” from the Main Menu. The following screen will appear:

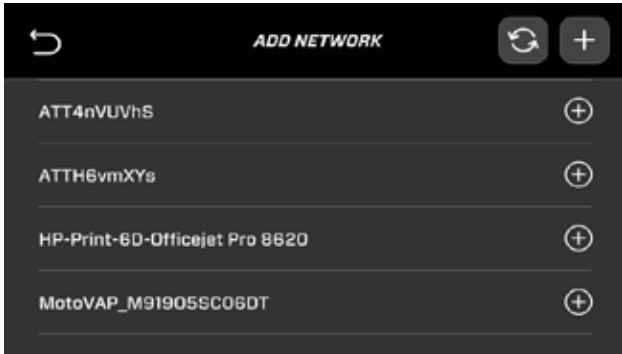

Touch . The following screen will appear. It provides a list of available wi-fi networks:



If necessary, you may touch  to refresh the list of available networks. If a network is present, yet is not displaying, touch . Then enter the network's name and password.

Upon successfully joining a wi-fi network, you will see a screen displaying the network's name. A notification will appear if any software updates are available at that time.

PV1100 and 1200 updates may also be downloaded and installed using a USB drive. Your authorized MasterCraft dealer can perform this task for you whenever an update is available.

## FUEL MANAGEMENT

In MasterCraft boats, the fuel management system directly connects the boat operator to the management of their fuel. This system collects precision information on fuel flow levels from the engine controller. It then calculates and displays the amount of fuel remaining based on engine activity and the usable size of the fuel tank.

As a safeguard against inaccurate readings, there is a back-up low fuel sensor that signals any discrepancies between the computer and the actual amount of fuel in the tank.

### Using Fuel Management Software

Upon keying the boat on, the touchscreen display will ask if you have added fuel to the boat.

If the answer is no, tap NO to exit the fuel management system. If the answer is yes, tap YES. This will display the fuel level entry page. Input the amount of fuel added, or tap the FULL button if the tank has been filled completely. Fuel levels will be displayed next to "Amount" at the top of the screen.

Press SAVE to exit to the menu screen.

Should an operator input the wrong amount of fuel, there are several fail-safes in place. To immediately correct an input error, navigate to the Main Menu tab. Select FUEL MANAGEMENT from the menu. This will re-open the fuel level entry page.

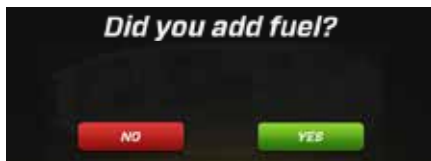

Using the keypad and the +/- button, adjust to the correct amount of fuel. Use a positive value if more fuel needs to be entered, or a negative value if too much fuel was entered.

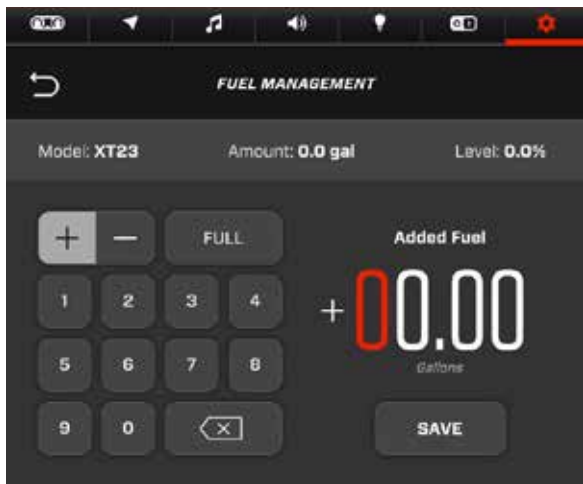

If the fuel management system senses that fuel is getting low, it will display a low fuel warning on the screen. The boat will be able to run unballasted for approximately 20 minutes before running out of fuel. When you see the low fuel warning, immediately empty all ballast tanks and proceed to a fueling station before engaging in any further activity. Continuing to operate the boat with low fuel levels could leave users stranded offshore.

If an operator has inaccurately or mistakenly entered the fuel level, there is a sensor in the fuel tank which will override the incorrect entry when low fuel is detected. In order to avoid false readings, the sensor will only override the fuel management system if and when it detects a low fuel level for more than 30 seconds with the engine operating at less than 900 RPM.

#### **To activate or deactivate the fuel management software:**

- Navigate to the Main Menu tab.
- Tap SYSTEM SETTINGS.
- On the System Settings Page, select either ENABLE or DISABLE under Fuel Management.

Disabling the fuel management software will allow the fuel gauge to read fuel levels directly from the sensor on the fuel tank. You must reset this sensor when disabling fuel management. To do so, cycle the battery switch ON then OFF. With the key switch OFF, fill the fuel tank to 100% full at a fueling station. Turn the battery switch ON, then turn the key switch back ON.

## WARNING

When the low fuel warning appears, immediately empty all ballast tanks and proceed to the nearest fueling station or dock.

# DIAGNOSTICS

You may access all PDM, EPDM, tab, and engine diagnostic information under DIAGNOSTICS in the Main Menu. Tapping any of the listed options will load system-specific diagnostics:

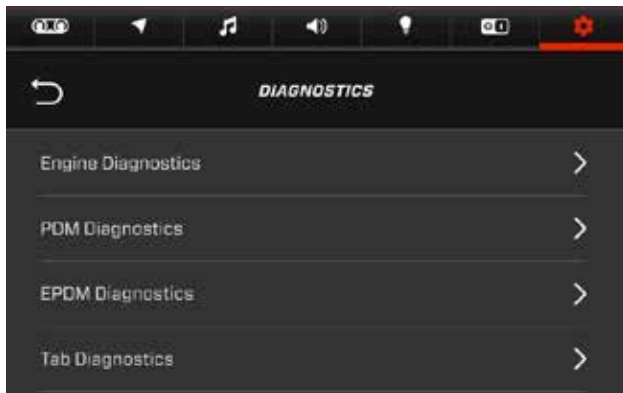

## Engine Diagnostics



This screen shows the number of active and stored faults, as well as the fault number currently displayed. To advance to the next fault, touch NEXT. Touch PREVIOUS to go back to the last fault. Use the following glossary to better understand this screen:

**SPN** — Suspect Parameter Number — fault code. If not translated into text by the display, see the engine manufacturer's literature for the definition of the SPN number.

**FMI** — Failure Mode Indicator — fault code. The FMI is defined by SAE J1939. If not translated into text, see the SAE standard or the engine manufacturer's literature.

**Description Field** — Most common SPNs and FMIs have text descriptions stored in the computer. If no description is visible, refer to the engine manufacturer or the SAE J1939 standard. NOTE: This field is only used with certain engine models.

**Corrective Action** — Tap GET FAULTS. This queries the engine(s) ECU for feedback on diagnostic codes activated and stored in the ECU for service needs.

## PDM Diagnostics



In MasterCraft boats, PDMs (Power Distribution Modules) provide electrical power to vehicle systems and act as circuit breakers for those systems. The PDM Diagnostics page displays faults for all PDM outputs, inputs, and CAN communications. To check all PDMs for faults, tap PDM 1, PDM 2, or PDM 3 on the PDM Diagnostics page. Faults for each PDM will be displayed on their respective pages. To reset existing faults, touch RESET FAULTS.

### Faults are color coded as follows:

- Red - Short Circuit or Out of Range
- Orange - Open Circuit
- Yellow - Overcurrent
- Green - No Faults / Active / In Range

## EPDM Diagnostics

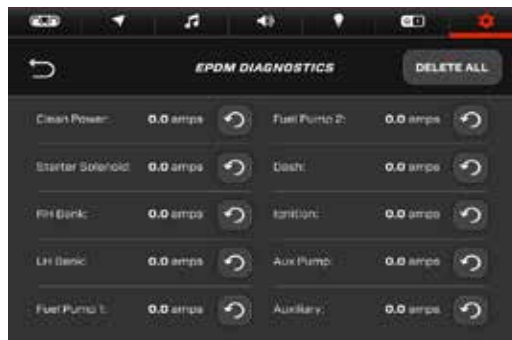

The EPDM is a type of PDM designed to make engine diagnostic checks easier and more convenient for quick, on-the-water fixes. To access the EPDM screen, select EPDM Diagnostics from the Diagnostics page under System Settings.

The EPDM screen displays critical engine and electrical system operating information. For each engine function, the screen displays amperage draw and digital switch status. Digital switch status is designated by green, red, and gray indicators.

- A **green indicator** denotes that the digital switch is functioning properly.
- A **red indicator** denotes that there is a problem with the digital switch and that it has tripped.
- A **gray indicator** denotes that the digital switch is currently unused or is not receiving power.

To reset a digital switch that has tripped, press the RESET button next to the system with a fault. To reset the entire EPDM, press the RESET ALL button in the bottom right corner of the screen.

If a digital switch continues to trip multiple times in one outing, this indicates a serious electrical issue. In such cases, the boat should be taken to an authorized MasterCraft dealer for repair.

## CAUTION

The EPDM and digital switches are designed to protect the engine and electrical system from damage. If a switch has tripped and continues to trip even after resetting the EPDM, it may be a sign of a larger electrical issue. The boat should be taken to an authorized MasterCraft dealer for diagnosis and repair.

# GPS SETTINGS

Accessed from the Main Menu/Settings Page, the GPS Settings Page includes options for managing waypoints, tracks, chart/time settings, depth/position settings, and satellite status.

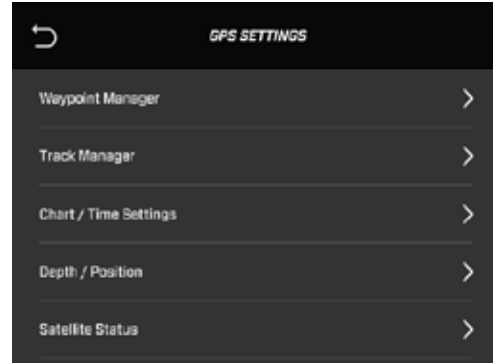

## Waypoint Manager



The Waypoint Manager lists existing waypoints to view, edit or delete.

- To plot a course to a specific waypoint, highlight the waypoint on

the list on the left side of the screen, and touch Start.

- To view a specific waypoint on the map, highlight the waypoint on the list on the left side of the screen and touch VIEW ON MAP.
- To edit the name of a waypoint, highlight the waypoint on the list on the left side of the screen and touch EDIT. (the pencil icon).
- To assign an icon to a waypoint, highlight the waypoint and touch the specific icon to be assigned (flag, anchor, fish or fuel).
- To delete a waypoint, highlight the waypoint and touch the trash can icon. To delete all waypoints, touch DELETE ALL.



## Track Manager

A track is a recording, displayed on the map, of where the boat has traveled. Tracks are only recorded when the RECORD TRACK button is selected. Once recorded, tracks will appear in the Track Manager to be edited, shown or hidden on the map, or deleted.

To edit a track name, navigate to the Track Manager and highlight the track on the list, tap edit. A keyboard will appear where operators can make necessary changes.

To show or hide a track, navigate to the Track Manager and highlight the track on the list. Touch SHOW TRACK or HIDE TRACK. When hidden, the track is saved in the memory, but will not appear on the screen.

To assign a color to a track, highlight the track and choose a color disk.

To delete one track in the Track Manager, highlight that track and touch the trash can icon. To delete all tracks, touch DELETE ALL.

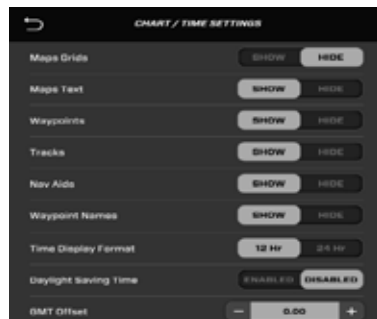

## Chart / Time Settings

Chart/Time Settings allow users to turn ON or OFF the following parameters. Touch the green or red squares to select or deselect:

- Show Grids
- Show Text
- Show Waypoints
- Show Tracks

- Show Nav(igation) Aids
- Show Waypoint Names

Adjust the GMT offset hours by touching the left or right arrows.  
If Daylight Saving Time is enabled in your location, touch DST Enabled to turn it on.

Choose the clock display you prefer: 12 hour format or 24 hour format.

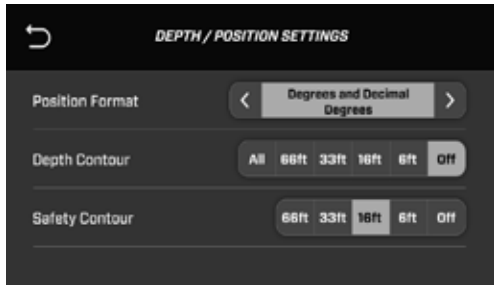

## Depth / Position Settings

The Position Format selection displays positions on the map in the following three GPS formats:

- Degrees, Minutes and Decimal Minutes (i.e., 79°58.93172W)
- Degrees, Minutes, Seconds and Decimal Seconds (i.e., 40°20'50.93172)
- Degrees and Decimal Degrees (i.e., 79.982195)

## Depth Contour

The Depth Contour setting allows an alarm to be displayed when the boat is detecting a water depth at or above the depth selected. The map will display depths within the lines as shown below. Choose a Depth Contour to be displayed by touching a preferred depth:

- Off
- 6 feet
- 16 feet
- 33 feet
- 66 feet

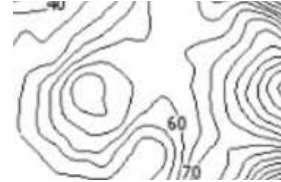

## Safety Contour

The Safety Contour will change the map's display color in areas of water that are at or deeper than the selected depth. These depths will be blue while depths shallower than the selected depth will be white. Choose a Depth Contour to be displayed by touching a preferred depth:

- Off
- 6 feet
- 16 feet
- 33 feet
- 66 feet





## Satellite Status



This screen will display a representation of all the satellites visible to the boat's GPS system.

## BALLAST AND TAB SETTINGS

See BALLAST AND TAB SETTINGS in this section of the MasterCraft Owner's Manual.

## SERVICE INFORMATION

From here, dealers can reset the system's oil change reminders or dealer service reminders. Dealer contact information can also be found here.

Oil Change Reset	Displays a question of "Reset Oil Change?" Tap YES or NO.
Dealer Service Reset	Displays a question of "Reset Dealer Service?" Tap YES or NO.
Dealer Information	Provides the Dealer contact information.

## FACTORY SETTINGS

This section requires a Dealer code to enter. If changes are needed, contact your Dealer.

# HV550 PASSENGER REMOTE



The optional MasterCraft HV550 is designed for control of various functions and integration with alternate systems on equipped X and X Star models. The multimedia HV550 Touch display provides controls for sounds, heaters, and lights.

## CARE AND MAINTENANCE

General maintenance is not required; however, a soft cloth can be used for cleaning the unit. Window cleaner or alcohol can also be used to clean the glass portion of the display. Do not use harsh or abrasive cleaners on the unit.

## BASIC NAVIGATION FEATURES

The HV550 contains the following touch commands:

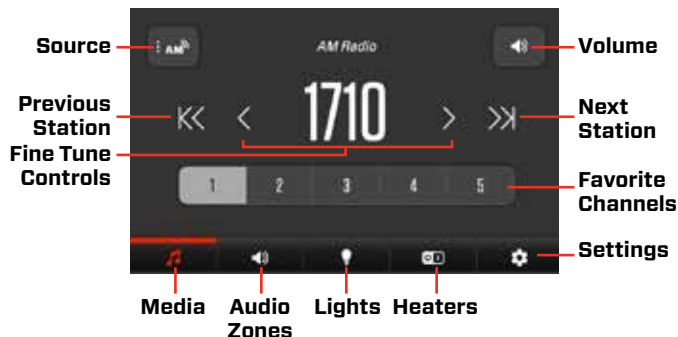

Component	Description
Media	Provides access to the sources for Bluetooth, USB Media and FM/AM/Weather Band radios.
Audio Zones	Provides access to the volume controls for each zone of the craft.
Lights	Provides access to customizable light controls on the craft.
Heaters	Provides access to the heater controls on the craft.
Settings	Provides access to brightness controls, system information and software update abilities.

# MULTIMEDIA CONTROLS

This area allows access to the sources available through Bluetooth, USB Media and FM/AM/Weather band radio signals. One of the following symbols will be displayed. Touch and choose the desired source.



# BLUETOOTH



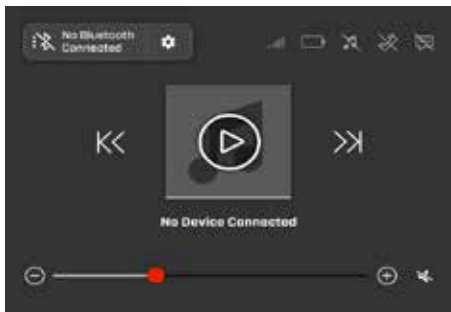

If the following screen appears when Bluetooth is chosen, follow the Bluetooth procedures prompted in the main entertainment system or refer to the Bluetooth procedures shown in the main entertainment system manual to connect and play Bluetooth sources:



# USB MEDIA

The HV550 will read the contents of the USB storage device inserted into the main entertainment system.

The following controls will be displayed:

Component	Description
	Repeat. Touching this button once will turn the symbol green and display a 1 (repeat one song). Touching this button twice will display All (repeat all songs).
	Reverse to the beginning of the song, then if pressed again reverses to the previous song.
	Play
	Fast forwards to the next song.
	Shuffles the songs so that they are played randomly.

# FM/AM RADIO

Choosing one of these options will display the chosen Radio band (AM shown below):



To select a channel, utilize the following controls:

Component	Description
>	Fine tune to the next highest number on the channel scale.
>>	Tune to the next available channel on the scale.
<	Fine tune to the last number on the channel scale.
<<	Tune to the previous available channel on the scale.

To save a favorite channel, dial in the appropriate channel then press and hold one of the five presets buttons shown for 3 seconds. The channel will be saved to the corresponding number.

## WEATHER BAND

The National Weather Service has seven different channels to obtain weather information. Select a channel (1-7) to obtain weather information for your particular area.

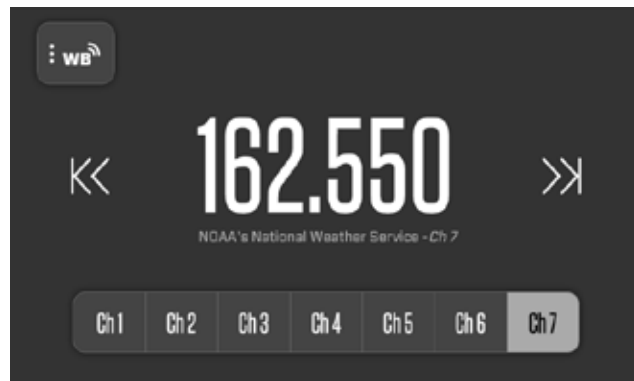

# SOUNDS

This section controls the volume in the various zones of the craft.

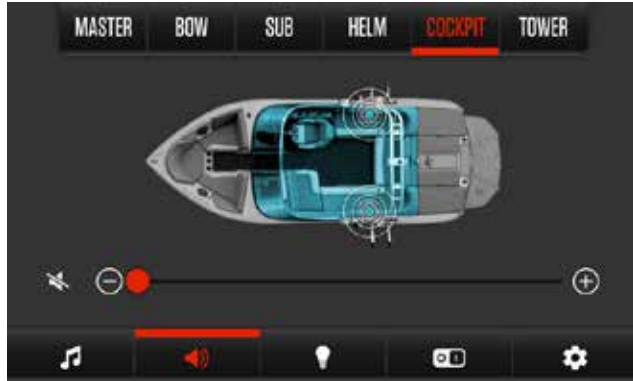

**To control the volume in each zone:**

1. Touch the desired zone (the Cockpit is shown highlighted in the above picture).
2. Slide your finger along the volume line below the picture to the desired volume.
3. To mute the sound in all zones except the highlighted zone, touch the mute symbol.

# LIGHTS

To turn on/off lights in a specific area, touch the corresponding On/Off bubble for that area.



Change the light colors by touching . Adjust the slider bar to the appropriate color and intensity and touch Done:



# HEATERS

To turn on or off the heaters, touch the On/Off bubble that corresponds to that switch.

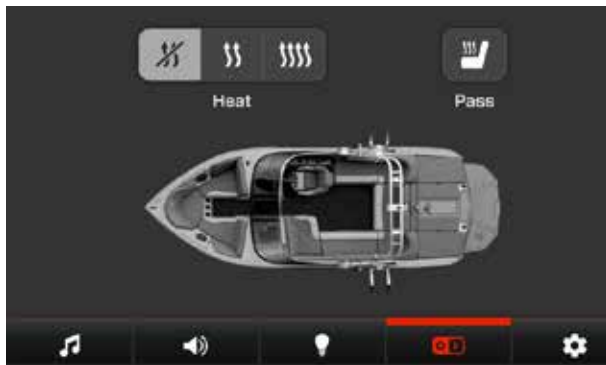

# SETTINGS

To control the screen brightness, tap on a desired area of the line.



# SYSTEM INFORMATION

This screen displays the version numbers of the installed software.

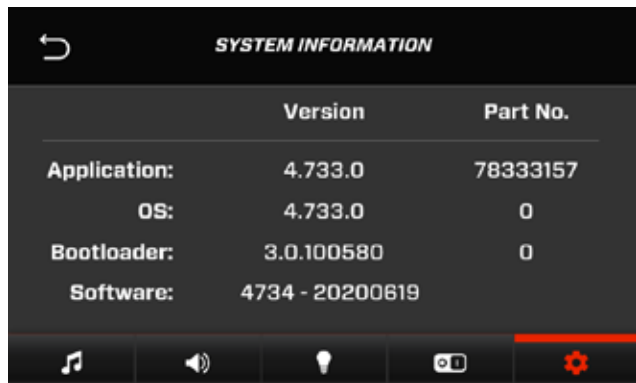

	Version	Part No.
<b>Application:</b>	4.733.0	78333157
<b>OS:</b>	4.733.0	0
<b>Bootloader:</b>	3.0.100580	0
<b>Software:</b>	4734 - 20200619	

# UPDATE SOFTWARE

This screen provides a method of updating the display software via a USB.

Insert a USB storage device that contains the update files into the system's USB drive.

Touch the Refresh button  and choose the appropriate update file to load.

# GENERAL TROUBLESHOOTING GUIDE

## Display appears not to work or doesn't come ON.

1. Display could be in sleep mode. Touch the screen to activate the display.
2. Check for loose connections at battery and display unit.
3. Check for reversed polarity on the power connections.
4. Verify battery has a minimum voltage of six volts.

## Display resets or goes OFF when starting engine.

5. Check display supply wires are connected properly to battery.
6. Verify battery is charged properly.
7. Check battery for efficient starter current.

## Display has no backlight.

Contact your MasterCraft service center.

## Display has no keypad backlight. (if present).

Contact your MasterCraft service center.





# X AND XT SERIES ENGINE GAUGES

This section discusses performance controls. Throughout the section, information is provided via traditional gauges; however, the vast amount of MasterCraft boat functions, as well as some convenience and support data described elsewhere in this Owner's Manual, are provided through a video display located on the lower right (starboard) side of the instrument panel. MasterCraft strongly encourages you to review ALL instrumentation with your authorized MasterCraft dealer prior to operating the boat for the first time, and at any time during ownership that you feel uncertain as to proper and applicable functionality. To read about the digital versions of the gauges discussed in the following chapter, see the PV1200 screen information found in this manual (p. 85-86, 99-100).

# SPEEDOMETER



The speedometer indicates the forward speed of the boat in miles per hour (unless the boat is equipped with a speedometer that measures kilometers per hour, which is available in the optional European package.)

# TACHOMETER



The tachometer indicates the engine speed in crankshaft revolutions per minute (RPM). See the Engine section of this Owner's Manual for important information regarding proper operating RPM levels, particularly during a boat break-in period.

# 3-IN-1 GAUGE



## Upper Half of Gauge: Fuel Gauge

Fuel Gauge readings are approximate. This gauge is activated with the ignition switch. The rocking motion of the boat during normal operation will cause the fuel gauge to fluctuate. For a more accurate read-

ing, make sure that the boat is level and there is little or no motion present.

A “low fuel notice” will appear on the video screen as a warning to return to shore and refuel. MasterCraft recommends that operators do not run the boat below a quarter of a tank of fuel, except as necessary to return to shore, and not until the boat has been operated enough times to develop an understanding of how the fuel gauge readings relate to the visual inspection of fuel remaining in the tank. Attempting to extend fuel usage beyond the known capability of the boat may cause the boat to run out of fuel and may leave you stranded off-shore.

Although it may be possible to see fuel in the bottom of the fuel tank, you still may not be able to operate the boat. The fuel pick-up system was designed to avoid introducing the small amount of water and debris that may unavoidably accumulate in the bottom of the fuel tank over time. Rather than relying on a visual inspection, you should pay attention to the fuel gauge.

Further, it is not recommended to allow the fuel level to fall below one-quarter of a tank at any time as it may result in damage to the fueling system. (See the Fueling section of this Owner's Manual.)

## CAUTION

Allowing the fuel level in the fuel tank to fall below one-quarter of a tank may affect the reliability of the fuel pump or result in damage to the fuel pump, which is not covered under warranty.



### Lower Right Side: Oil Pressure Gauge

The engine oil pressure gauge indicates the pressure of the lubricating oil inside the engine. The average pressure ranges are between six (6) pounds per square inch (PSI) at 1000 RPM to 40 PSI or more at

cruising-range speeds. A reading of pressure below 5 PSI at 1000 RPM may be caused by a low oil level or other potentially serious problems that result in low oil pressure, causing a red warning light to appear at the bottom of the gauge.

If you experience low oil pressure, stop your engine immediately and check your oil level before operating again.

## CAUTION

Do not continue to run the engine if the oil pressure is low. If you do, the engine may become so hot that it, or surrounding components, could catch fire. You or others could be burned and the boat seriously damaged. Check your oil level and add an appropriate amount of approved motor oil before operating again or have your boat serviced by your local authorized MasterCraft dealer's service department. Note that damage to your engine from inappropriate oil levels can be costly to repair. Such damage is not covered by your warranty.



### Lower Left Side: Engine Water Temp

The temperature gauge indicates the water temperature inside the engine's cooling system as measured in degrees Fahrenheit. The normal operating temperature will range from 140 degrees Fahrenheit to 190

degrees Fahrenheit. Engines with electronic fuel injection also have a control circuit inside the engine control module that will cause the engine to run at reduced speeds if the module senses that the engine is running too hot. If you notice that your speed has reduced during normal operation, but you have not manually slowed the throttle, monitor your temperature gauge.

If the gauge indicates excessive temperatures during operation, slow down immediately and turn off the engine. This indicates an engine problem that needs to be checked by your authorized MasterCraft dealer.

## **CAUTION**

**Continuing to operate the boat while the temperature is above normal operating parameters may cause serious damage to your engine. Damage to your engine resulting from operating the engine in an overheated condition can be costly to repair. Such damage is not covered by your warranty!**

# X AND XT SERIES 7" TOUCHSCREEN DASH OPERATION

The X and XT Series 7" Touchscreen Dash is designed for instrumentation and control on electronically controlled engines communicating via SAE J1939 and NMEA 2000. The multimedia display provides cruise control and rider profiles, and enables boat operators to view many different engine, ballast, transmission parameters and service codes.



We continually strive to bring you the highest quality, full-featured products. As a result, you may find that your actual display screens may be slightly different than what is depicted in this Owner's Manual.

The 7" Touchscreen is designed for instrumentation and control on electronically controlled engines communicating via CAN networks. The screen displays information based on the operating mode of the boat and acts as the command center for all of the boat's systems.

## CARE AND MAINTENANCE

General maintenance is not required; however, a soft cloth can be used for cleaning the unit. Glass cleaner or alcohol can also be used to clean the glass portion of the display. Do not use harsh or abrasive cleaners on the unit.

### CAUTION

**Avoid contact between sharp or hard objects and the video screens, as this can result in scratches or other permanent marks on the screen. Clean only with a soft cloth, using glass cleaner or rubbing alcohol only. Never use harsh or abrasive cleaners on the unit, as this may result in damage to the unit that is not covered under warranty.**

## 7" TOUCHSCREEN (PV700): NAVIGATION AND OVERVIEW

Navigation within the 7" Touchscreen is controlled via touch commands. The information displayed onscreen varies depending on the operating mode selected (Drive or Tow). Regardless of the mode selected, certain information is displayed at all times. The screen always presents battery charge, water depth, engine hours, water/air temperature, and time at the top of the display.

Note that boats equipped with the PV700 feature a suite of gauges that present operating information onscreen, including speed, RPM, fuel level, oil pressure, and engine temperature.

### Operating Modes

The PV700 is organized around two main on-water activities: driving from place-to-place and towing riders. To correspond with these activities, the PV700 features two primary operating modes (Drive and Tow), plus three Tow sub-modes (Surf, Wake and Ski).

- **Drive Mode** displays basic operating information for cruising. From Drive Mode, you can quickly adjust speed, tabs, and ballast.
- **Tow Mode** is broken down into three sub-modes: Surf, Wake, and Ski. Factory-loaded profiles for ballast, speed, and tab configurations are easy to select and modify from each sub-



mode. Each sub-mode features custom profile creation.

To switch between modes, use the tabs located at the bottom of the touch display. Touch DRIVE to access Drive Mode. Touch SURF, WAKE, or SKI to access one of the Tow Mode variants.

Note that operators cannot switch between modes while the throttle is in gear (forward or reverse).



## DRIVE MODE

Drive Mode displays basic operating information for cruising around your body of water. In Drive Mode, quickly fill or empty ballast, adjust tab positions, and activate speed control. Drive Mode is the default setting when the system first powers on.

### Drive Mode Screen:

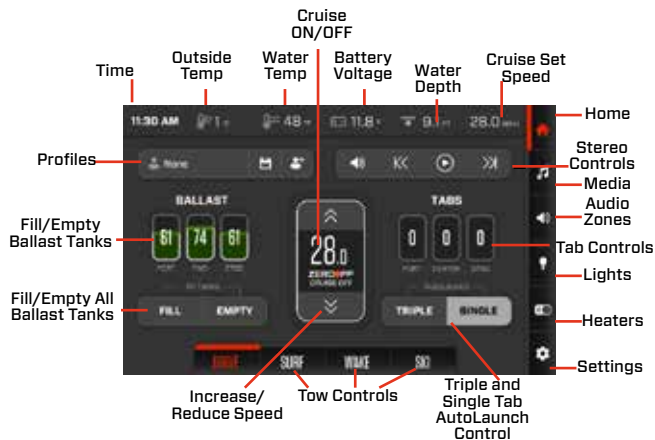

Component	Description
Mode Selection	<p>Allows the user to select an operating mode:</p> <ul style="list-style-type: none"> <li>• Drive Mode: Optimized for cruising from place-to-place. Includes controls for Auto-Launch, speed, ballast and tabs</li> <li>• Surf Mode (Rapid/Custom): Provides access to 7 wave profiles, as well as custom profiles. Allows the user to customize wave position, ballast levels, and tab settings.</li> <li>• Wake Mode: Provides access to custom and factory-set wake profiles, AutoLaunch controls, and ballast levels.</li> <li>• Ski Mode: Provides access to custom and factory-set ski profiles, AutoLaunch controls, and ballast levels.</li> </ul>
AutoLaunch Control (Triple and Single)	<p>When AutoLaunch Single is turned on, the center tab helps push the boat up to plane.</p> <p>When AutoLaunch Triple is turned on, all three tabs help push the boat up to plane.</p>
Tab Controls	Allows the user to individually adjust tabs
Fill/Empty All Ballast	Provides a quick way to fill or empty all of the ballast tanks and bags at one time
Adjust Cruise Set Speed	Allows the user to adjust cruise control speed
Cruise ON/OFF	Turns the speed control system on or off
Fill/Empty Ballast Tanks	Allow the user to individually adjust each ballast zone (center tank, individual side tanks/bags, midship tank when equipped)

Component	Description
Media	Allows the user to adjust AM/FM/Weather Bands, Bluetooth devices, and USB devices
Audio Zones	Allows the user to access volume and equalizer controls for the entire boat
Lighting	Activate or deactivate the standard and optional lighting devices found on the boat
Heaters	Allows the user to control various accessories including the blower, heater, seat heaters, and bilges
Settings	<p>Allows the user to access:</p> <ul style="list-style-type: none"> <li>• System Settings</li> <li>• Bluetooth Manager</li> <li>• Fuel Management</li> <li>• Diagnostics</li> <li>• GPS Settings</li> <li>• Ballast / Tab Settings</li> <li>• Service Information</li> <li>• Factory Settings</li> </ul>
Profiles	Allows the user to create and save/store custom rider profiles.

# BALLAST

To fill the ballast tanks, touch FILL ALL. Alternatively, tap the ballast area to adjust individual ballast zones. Note that some models feature four ballast tanks and some models feature three.

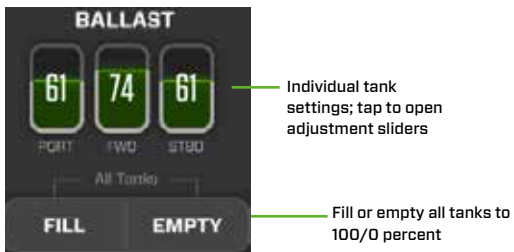

Tapping the ballast area will pull up the following screen:



From the ballast screen, users can fill or empty all ballast zones by touching FILL ALL or EMPTY ALL. To pause the fill process, tap STOP ALL. To adjust individual ballast zones, touch the UP or DOWN arrows at the top or bottom of the ballast zone you wish to fill or empty.

Alternatively, you may slide your finger along the ballast progress bars to adjust ballast zones and set custom fill levels.

# ADJUSTING TABS

Tabs allow you to precisely dial in your wakes and waves, sculpting the water as it leaves the hull bottom. Touching the tab area will pull up a page that allows you to adjust individual surf tabs.



Touch the up and down arrows to adjust a tab. Alternatively, adjust the tab by sliding your finger along the slider.

# BALLAST AND TAB SETTINGS

Located under Main Menu/System Settings, the Ballast/Tab Settings page allows you to establish fill and drain times for each ballast zone, along with the timing of center and surf tab crossovers. MasterCraft does not recommend adjusting fill times, as these have been factory-set for specific reasons. If you desire to modify the timer settings on your boat, contact your authorized MasterCraft dealer.



## AutoLaunch Crossover Settings

AutoLaunch is the logic software which automatically deploys and retracts the surf tabs. When active, AutoLaunch will automatically deploy either one or all three of the tabs, allowing the boat to quickly get on plane. As the boat accelerates and reaches its approximate planing speed—also known as crossover speed—the tabs will automatically retract to their normal running positions. (Note that, for most activities, Single Tab AutoLaunch is sufficient.)

Crossover speeds are pre-set, but may be adjusted from the Ballast/Tab Settings page. The crossover speed is the speed at which the boat no longer needs assistance reaching a fully-planed position. There is only reason the user should ever adjust crossover speed: if the boat's normal operating weight is consistently very light or very heavy. In such cases, the speed can be decreased for light weight boats and increased for heavier boats.

Adjusting the crossover speed will take some experimentation. The goal is to get the boat on plane quickly and without causing any spray. If your boat will be heavily weighted with persons/ballast for any consistent period, increase the crossover speed to keep the tabs in the down (deployed) position longer. You can raise crossover speed by tapping the + next to the tab(s) you wish to increase.

If you plan to consistently run the boat without ballast or with only a few people, decrease the crossover speed to pull the tabs up earlier. To decrease the crossover speed for a particular tab (center tab or Surf tab), tap the - next to that tab.

# CRUISING

The 7" Touchscreen simplifies cruising to and from the best riding spot on the lake by allowing operators to easily get the boat's ballast and tabs settings prepared for a set.

Heading Out: To prepare the boat for a riding session on the way to

your favorite spot, navigate to Drive Mode. The boat will default to 28 MPH and AutoLaunch Single will default to the ON position. If necessary, use AutoLaunch Triple. Tap FILL ALL to start filling the ballast tanks. Note that boats equipped with FastFill ballast systems cannot be filled with the engine operating above 1,500 RPM. The pumps are so much faster than typical ballast pumps that they can be filled upon arriving at your riding spot.

Heading Home: At the end of the day when it's time to head home and empty the ballast tanks, navigate to Drive Mode. AutoLaunch Single will default to the ON position and speed control will default to 28 MPH. Tap EMPTY ALL to drain the ballast tanks. Note that boats equipped with FastFill ballast systems cannot be filled with the engine operating above 1,500 RPM. If necessary, turn AutoLaunch Triple ON to assist the boat to reach a fully-planed



position. Navigating to Drive Mode will always cancel any active Tow Mode profiles but will not drain the ballast tanks.

To activate and deactivate cruise, simply tap the center Cruise button. When On, the button's outline will be green (as seen above).

# TOW MODE

## Surf Mode: Overview

Surf Mode is divided into 2 distinct menus: Rapid Surf and Custom Surf. From the Rapid Surf menu, you may choose the shape of your wave by selecting 1 of 7 different wave presets. Use the controls provided on the lefthand side of the screen to easily select a preset. Doing so will modify the steepness of your wave.



When Surf Mode is first selected, Rapid Surf is the default menu setting. To toggle between Rapid Surf and Custom Surf, use the button located near the top righthand corner of the screen. Custom

Surf provides additional options for seasoned athletes, such as tab and ballast control. For more information on Rapid Surf and Custom Surf operation, refer to the dedicated sections below.

## Rapid Surf

Rapid Surf allows you to easily select a wave by adjusting the slider on the lefthand side of the screen. Alternatively, use the arrows located immediately to the right of the slider. Hitting the “Up” arrow or raising the slider will create a steeper wave. Hitting the “Down” arrow or lowering the slider will create a mellower wave.

From the Rapid Surf menu, you may also choose the position of your surf wave. Selecting SURF RIGHT will create a starboard wave. Selecting SURF LEFT will create a port-side wave.

Any adjustments made to your surf wave will appear on the graphic to the right of the adjustment controls. Whenever new adjustments are made, a readiness timer will indicate the load time.

In addition to preset profiles, Rapid Surf also supports custom profiles. For more information on the profile creator, see the section of this chapter titled “Creating a New Surf Profile.”

## Using Rapid Surf to Select a Wave

Rapid Surf is intended to make wave customization a quick and easy process. In a few simple steps, you can build an amazing surf wave and hit the water in no time.

1. Before you begin setting up your wave, make sure that Surf Mode is selected and set to the Rapid Surf menu. When Rapid Surf is active, you will see a screen resembling this one:



2. Locate the slider and arrows found on the left-hand side of the screen. These controls allow you to choose between 7 wave types. Each wave has been designed to suit a particular surf style. 1 is the mellowest, shortest wave and is suited to beginners. 7 is the steepest, tallest wave and is suited to advanced surfers. The average surfer will most likely opt for presets 3-5. **Note:** For each of the 7 wave types, there is a SURF LEFT and SURF RIGHT variant. As a result, there are 14 presets in total.

- Use your finger to drag the slider to the desired wave preset. Alternatively, use the arrows to the right of the slider.
- Using the SURF LEFT/SURF RIGHT buttons, choose the position of your surf wave. Selecting SURF LEFT will direct the surf tabs to create a port-side wave. Selecting SURF RIGHT will direct the surf tabs to create a starboard wave.
- The readiness timer will display the amount of time required for the wave to be sculpted. Wait for it to finish.



- If you already have a surf profile selected, you may save your adjustments to said profile by clicking . Doing so will save any active values to the profile currently selected.

## Custom Surf

Custom Surf provides access to additional, in-depth wave settings. From this menu, you may adjust ballast fill levels, tab positions, wave position, and ZeroOff cruise control. You may also create and manage custom surf profiles. With its deep customization features, this menu is designed for experienced wakesurfing enthusiasts looking to craft a wave that perfectly suits their style.



To access the Custom Surf menu, select CUSTOM SURF from the toggle pane near the top righthand corner of the screen.

## Creating a New Surf Profile

Both Rapid Surf and Custom Surf allow you to create your own custom surf profile with individualized tab, ballast, and speed settings. The profile may then be stored for later use. To create a custom surf profile, follow the instructions below.

1. Select  from the panel near the top of the screen.
2. The following menu will appear onscreen. From this menu, you may adjust ballast fill levels, tab deployment, speed, and cruise control (on/off). You may also tap SURF LEFT or SURF RIGHT to set the wave position. (Tapping a ballast zone or surf tab will take you to a dedicated ballast or tab adjustment screen.)



3. When you are satisfied with your settings, touch the NEXT button. Doing so will save the adjustments to your profile and take you to the next step in the profile creation process.



4. Using the keyboard provided, give your profile a name.



5. Tap SAVE & ACTIVATE if you want to save and immediately activate your new profile. Tap SAVE & CLOSE if you want to save the profile for later use. Saved profiles can be accessed at any time by using the profile manager.

## Using the Profile Manager

Once a profile has been created, you can access it using the profile manager. This menu allows you to select, edit, or delete custom profiles. It may hold up to 30 profiles at a time.

1. Select  from the panel near the top of the screen.
2. The profile manager will appear onscreen. Using the profile manager, you may select a custom profile from the catalog on the righthand side of the screen. You may also edit or delete custom profiles by selecting  or .



- Use the catalog to find the desired profile.



- Tap the profile to select it.
- Once the profile is selected, touch the ACTIVATE button. Doing so will immediately activate the profile.
- When you no longer wish to use the profile, select it again and touch the DEACTIVATE button.

## Wake Mode

Wake Mode is intended solely for wakeboarding. Like Surf Mode, it enables control of surf tabs and ballast zones, allowing the user to influence the shape and intensity of the wake generated by the boat's WSDs. Wake Mode includes 3 stock wake profiles: **Beginner**, **Intermediate**, and **Advanced**. MasterCraft recommends that you select the profile best corresponding to your level of ability.



- Beginner** - Designed for new riders who are still learning to wakeboard. Allows the user to get comfortable wakeboarding at slower speeds. The user may begin learning surface tricks and wake crossings. Recommended line length: 55-60'.
- Intermediate** - Designed for moderately experienced riders learning their first wake-to-wake jumps, basic inverts, and spins. Recommended line length: 55-65'.
- Advanced** - Designed for highly experienced riders seeking bigger airs for advanced tricks. Recommended line length: 65-75'.

All 3 stock profiles are accessible from the Wake Mode home screen. To activate a stock profile, tap the one you wish to use. The button will turn light gray, indicating that the profile is active.

## Custom Wake Profiles

In addition to letting the user select a stock profile, Wake Mode also allows for the creation of custom wakeboard profiles. Once created, these profiles can be saved and stored for use at any time. To build a profile, complete the following series of steps.

1. Select  from the panel near the top of the menu. You will see a page resembling the home screen. From this screen, you may adjust tab, ballast, and cruise control. Selecting an individual tab or ballast zone will take you to a dedicated tab/ballast page.
2. When you are satisfied with your settings, touch the NEXT button. Doing so will save any adjustments made to your profile and take you to the next step in the profile creation process.
3. Using the keyboard provided, give your profile a name.
4. Tap SAVE & ACTIVATE if you want to save and immediately activate your new profile. Tap SAVE & CLOSE to save the profile for later use. Saved profiles can be accessed at any time using the profile manager, pictured below.

## Ski Mode

Ski Mode is intended solely for skiing. Like the other tow mode variants, it includes options for adjusting tabs, ballast, and cruise control. MasterCraft has one predefined ski profile: **Ski**. To activate this profile, tap the SKI button under the ZeroOff button.

## Custom Ski Profiles





To create a custom ski profile, follow these steps:

1. Select . Adjust and set tabs, ballast, and cruise control.
2. When you are done, touch the NEXT button.
3. Using the keyboard provided, give your profile a name.
4. Tap SAVE & ACTIVATE to save and activate your new profile. Tap SAVE & CLOSE to save the profile for later use.

# MEDIA

Select the Media icon  and the following screen will appear:



Component	Description
	Audio Source Tab - Provides access to AM/FM/Weather bands, Bluetooth and USB media selections.
	Volume Control - Sliding a finger across the volume slider will increase and decrease volume.
	Volume Mute - Touch to mute or un-mute the stereo.
	Bluetooth and Music Icons - The Bluetooth icon will illuminate when a mobile device is connected via Bluetooth. The music note icon will illuminate when the boat plays music from the Bluetooth connected device.

## FM/AM Radio

All radio controls are integrated into the 7" Touchscreen display. Change stations, fine tune stations or adjust the volume, all on the display.

To increase the master volume, slide your finger along the volume control line at the bottom of the screen. To mute the sound, touch the Mute button to the right of the volume control line.

To search for the next available station signal, touch Next Station. To search for a station in reverse order, touch Previous Station. To fine-tune the signal, touch the single fine-tune arrows.

To save a favorite station, tune to that station and press/hold one of the available slots for approximately 3 seconds.

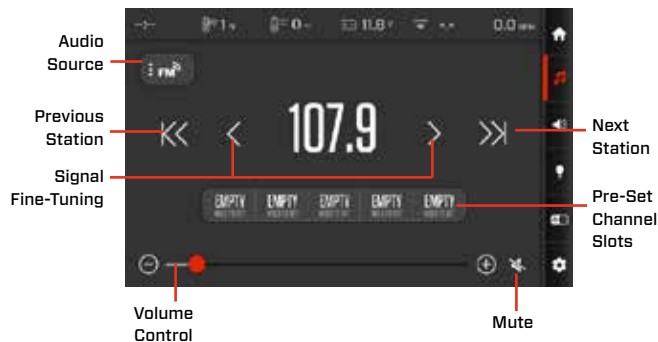

## Weather Band

The National Weather Service has seven different channels to obtain weather information. Select one of the channels (1-7) to obtain weather information for your particular region.



## USB and Bluetooth Audio Connections

Connecting a phone or MP3 player via USB and Bluetooth allows your personal music collection or an online music service like Spotify or Pandora to be played through the boat's audio system. Bluetooth and USB connections each have their benefits, but to take full advantage of all of the features the boat has to offer, MasterCraft recommends connecting your device via Bluetooth and USB cable.

Connecting via USB cable offers the best audio quality, displayed album art and song information, faster timing, charging and full control over the playlists and menus on select Apple and Android devices. Connecting via Bluetooth gives operators wireless audio, and displayed song information.

### To Connect via Bluetooth:

1. Ensure that your device's Bluetooth is turned on.
2. On the 7" Touchscreen navigate to the Bluetooth Manager in the Settings Menu. All discoverable Bluetooth devices will appear. If you have not connected the new device with the boat before, touch "+Add New Device" to connect the device.



3. The screen will display ADD NEW DEVICE. Tap OK, then ensure that your device's Bluetooth setting is ON and that your device is Discoverable to new connections.
4. The MasterCraft unit will begin to search for your device. Once the boat has discovered your device, tap your device's name and a message will display stating "Confirm Pairing on Your Phone."
5. On your device, a Bluetooth Pairing Request will appear. Touch OK. The device and the boat's screen will now be connected.

### To Connect via USB Cable:

1. Plug your device's charging cord into the USB port, mounted under the throttle control.
2. Your device will begin charging and will be connected to the boat's system.
3. Navigate to, and select USB MEDIA from the stereo source list to get access to your phone's music collection. Launch a music application on your device and it will display on the screen (Apple devices only, Android devices can only play music that has been downloaded to the device's internal storage).

## BLUETOOTH SETTINGS

Connecting via Bluetooth allows operators to connect to the boat wirelessly, play audio and display song information. To customize Bluetooth settings, navigate to the settings tab and select BLUE-TOOTH MANAGER. From here you can pair new devices or re-connect paired devices using the on screen buttons. To pair a new device, select +ADD NEW DEVICE and follow the on-screen prompts.

## VOLUME / EQUALIZER

### Audio Zones

This tab allows full control over the sound zones in the boat. The software features both a master volume and four individual zone volumes: Bow, Sub, Cockpit and Tower.

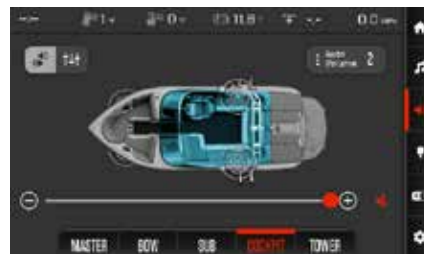

The zone volume levels reflect a percentage of the overall master volume. If the master volume is at 20 and a zone is at 40, then the zone is playing at 100 percent of the current master volume level. If a zone volume level is set at 20, then the volume in that zone is playing at 50% of the overall master volume. To play the speakers at maximum volume, turn all zones up to 40, then turn the master up to 40.

Mute a zone by selecting a zone and tapping the mute button (  ). Mute all zones by deselecting all zones then tap the mute button.

## Equalizer

The equalizer allows operators to adjust bass, mid and treble ranges. Slide a finger on each selection to tune the boat.

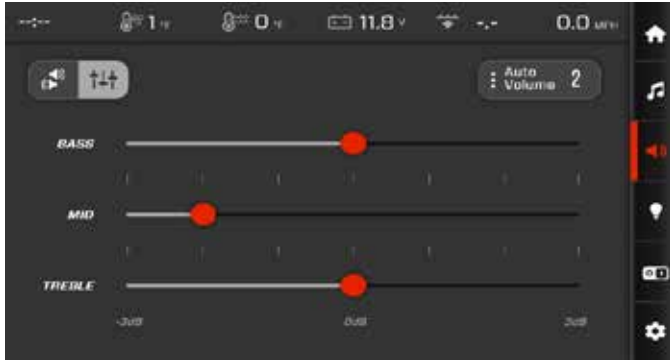

## Auto Volume

Auto volume controls how aggressively the volume level reacts to boat speed and can be tuned by selecting one of the five auto volume levels. Touch either OFF or 1-5 in the Auto Volume area to change this responsiveness (1 being the least aggressive adjustment, and 5 being the most aggressive adjustment).



## LIGHTING

To turn lights ON or OFF for a specific zone, touch the ON/OFF button that corresponds to the lighting zone. When turned ON, the button will be light gray.



Use the - and + buttons to adjust the intensity of the speaker lights.

To edit the color of the lights, touch , then slide your finger to the desired light and intensity. Then touch Done.

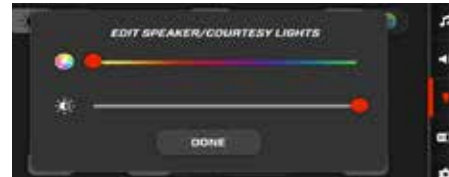

# ACCESSORY SWITCHES

Within the switches tab, the blower, bilge pumps, seat heaters and cockpit heater can all be turned ON and OFF. When turned ON, the button will be light gray.

**NOTE:** The blower automatically activates and runs for four (4) minutes when the key is turned to the ON position. To turn the blower on manually, navigate to the switches tab. Tap the button to toggle the blower ON and OFF.



# MAIN MENU/SETTINGS

The Main Menu/Settings page contains all of the settings and customization options for the 7" dash. From the Main Menu operators can adjust Bluetooth Settings, Fuel Management, Diagnostics, Tab and Ballast settings and GPS settings.



# SYSTEM SETTINGS

Easily adjust the system's major settings, including standard or metric units, fuel management, depth alarms and brightness.



Component	Description
Units	Choose which numbering format is being used, US Standard or Metric. This will change depth numbers, fuel volume numbers, temperature and speed.
Fire Extinguisher Pop-up	Displays a pop-up that shows when the engine compartment fire extinguished is active, or when it has been activated.
Fuel Management	When enabled fuel management calculates fuel levels based on engine activity and RPM.
Fuel Alarm	Will display an alarm when the fuel level reaches the saved percentage amount.
Minimum Depth Alarm	Will display an alarm when the established minimum depth can be detected. This can be adjusted in increments of six (6) inches.
Brightness Day	Allows adjustment of the screen brightness during the daylight hours. Slide your finger or touch along the line to adjust brightness levels.
Brightness Night	Allows adjustment of the screen brightness during the nighttime hours. Slide your finger or touch along the line to adjust brightness levels.
Tuner Region	Select your location so the AM/FM radio can optimize stations best for your location.
Update Software	Your authorized MasterCraft dealer can update the software version on your Dual Screen Dash via the Spark Network or USB.

## BLUETOOTH MANAGER

See BLUETOOTH AUDIO in this section of the MasterCraft Owner's Manual.

## SPARK NETWORK CONNECTION

This section provides a method of updating the display software via the connection to a Wi-Fi network.

1. Select Add Network to connect to a new Wi-Fi network.
2. Select the network to be connected.
3. Enter the network password.
4. Once connected, review this area to determine if an update is available.

## FUEL MANAGEMENT

The fuel management software in MasterCraft boats directly connects the boat operator to the management of their fuel. This system collects precision information on fuel flow levels from the engine controller. It then calculates and displays the amount of fuel remaining based on engine activity and the usable size of the fuel tank.

As a safeguard, there is a back-up low fuel sensor that signals any discrepancies between the computer and the actual amount of fuel in the tank.





## Using Fuel Management Software

Upon keying the boat on, the touchscreen display will ask the operator if fuel has been added to the boat.

Tap NO on the screen to close the fuel management system, or tap YES to display the fuel level entry page. The operator can input the amount of fuel added, or tap the FULL button to indicate that the tank has been filled completely. Fuel levels will be displayed next to “Amount” at the top of the screen.

Press SAVE to exit to the menu screen.

Should an operator input the wrong amount of fuel on the fuel entry page, there are several fail-safes in place. To immediately correct an input error, navigate to the Main Menu tab and scroll to and tap FUEL MANAGEMENT. This will re-open the fuel level entry page. Use the keypad and the +/- button to adjust to the correct amount of fuel. Use a positive value if more fuel needs to be entered, or use a negative value if too much fuel was entered.

When the fuel management system senses that fuel is getting low it will display a low fuel warning on the screen. When this warning is

displayed, the boat will be able to run unballasted for approximately twenty (20) minutes (without any ballast) before running out of fuel. Empty all ballast tanks and immediately proceed to a fueling station before any further activity. Continuing to operate the boat with low fuel levels could leave users stranded offshore.

If an operator has inaccurately or mistakenly entered the fuel level, there is a sensor in the fuel tank that will override the entered fuel level when it senses low fuel. To avoid false readings, the sensor will only override the fuel management system when it detects a low fuel level for more than 30 seconds with the engine operating at less than 900 RPM.

### To ENABLE or DISABLE the fuel management software:

- Navigate to the Main Menu tab and tap SYSTEM SETTINGS.
- On the system settings page, select either ENABLE or DISABLE under Fuel Management.

Disabling the fuel management software will allow the fuel gauge to read fuel levels directly from the sensor on the fuel tank. You must reset the sensor when disabling fuel management. To do this, cycle the battery switch ON then OFF. With the key switch OFF, fill the fuel tank to 100 percent full at a fueling station. Turn the battery switch ON, then turn the key switch back ON.



**When low fuel warning is displayed immediately empty all ballast tanks and proceed to the nearest fueling station or dock.**

# DIAGNOSTICS

All engine, PDM, EPDM and Tab diagnostic information can be found under DIAGNOSTICS on the main menu. Tap one of the four diagnostic options to pull up system diagnostics.

## Engine Diagnostics

Shows the number of both Active and Stored faults and which fault number is currently being displayed. To advance to the next fault, touch NEXT. Touch PREVIOUS to go back to the previous fault.

**SPN** — Suspect Parameter Number — fault code. If not translated into text by the display, see the engine manufacturer's literature for the definition of the SPN number.

**FMI** — Failure Mode Indicator — fault code. The FMI is defined by SAE J1939. If not translated into text, see the SAE standard, or the engine manufacturer's literature.

**Description Field** — Most common SPNs and FMIs have text for the description stored in the display. If there is no text, refer to the



engine manufacturer or the SAE J1939 standard. NOTE: This field is only used with certain engine models.

**Corrective Action** — Tap GET FAULTS. This queries the engine(s) ECU for feedback on diagnostic codes activated and stored in the ECU for service needs.

## PDM Diagnostics

PDM Diagnostics displays faults for outputs, inputs and CAN communications for PDM modules. XT Series models have two PDMs. X Series models have three. To check all PDMs for faults, tap PDM 1, PDM 2 or PDM 3 on the PDM Diagnostics page. Faults on each PDM will be displayed on their respective pages. To reset existing faults, touch RESET FAULTS.

**Faults are color coded as follows:**

- Red - Short Circuit or Out of Range
- Orange - Open Circuit
- Yellow - Over-Current
- Green - No Faults / Active / In Range

## EPDM Diagnostics

The EPDM is a solid state engine fuse block designed for all MasterCraft boats to make engine diagnostic checks easier and more convenient for quick, on the water fixes. To access the EPDM screen tap EPDM Diagnostics from the Settings Menu.

The EPDM screen displays critical engine and electrical system op-



erating information. Amperage draw and the status of internal digital switches are displayed for each engine function. Digital switch status is designated by either a green, red or gray indicator.

- A green indicator denotes that the digital switch is functioning properly.
- A red indicator denotes that there is a problem with the digital switch and it has tripped.
- A gray indicator denotes that the digital switch is currently unused or not receiving power.



To reset a tripped digital switch, press RESET next to the system with a fault. To reset the entire EPDM, press RESET ALL on the bottom right portion of the screen.

If a digital switch continues to trip multiple times in one outing, it is a sign of a larger electrical issue and the boat should be taken to an authorized MasterCraft dealer for diagnosis and repair.

## CAUTION

**The EPDM and digital switches are designed to protect the engine and electrical system from damage. If a switch has tripped and continues to trip even after resetting the EPDM, it may be a symptom of a larger electrical issue, and the boat should be taken to an authorized MasterCraft dealer for diagnosis and servicing.**

## Tab Diagnostics

Tab Diagnostics will provide a method to recalibrate the Tabs by touching Calibrate.



# GPS SETTINGS

Accessible by tapping the Main Menu/Settings button, GPS Settings has options for Time Settings and Satellite Status.



## Chart / Time Settings

Chart/Time Settings allow users to adjust the following:

- Time display format (24 hr. or 12 hr. display)
- Enable or disable Daylight Saving Time (DST Enabled to turn it on)
- GMT Offset - adjust the clock to your local time using the +/-.



## Satellite Status

This screen will display a representation of all of the satellites visible to the boat's GPS system.

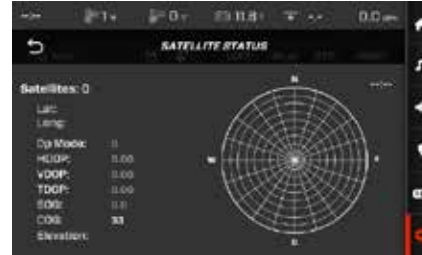

# BALLAST AND TAB SETTINGS

See BALLAST AND TAB SETTINGS in this section of the MasterCraft Owner's Manual.

# SERVICE INFORMATION

From here, dealers can reset the system's oil change reminders or dealer service reminders. Dealer contact information can also be found here.



Component	Description
Oil Change Reset	Displays a question of “Reset Oil Change?” Tap YES or NO.
Dealer Service Reset	Displays a question of “Reset Dealer Service?” Tap YES or NO.
Dealer Information	Provides the Dealer contact information.

# FACTORY SETTINGS

This section requires a Dealer code to enter. If changes are needed, contact your Dealer.

# TROUBLESHOOTING GUIDE

## Display appears not to work or doesn't come ON:

- Check for loose connections at battery and display unit.
- Verify battery has a minimum voltage of 10 volts.

## Display resets or goes OFF when starting engine:

- Check to ensure that display supply wires are connected properly to battery.
- Verify that the battery is charged properly. If the battery is not charged, use a battery charger to charge the batteries, or run the engine until battery power has been restored.
- Check battery for efficient starter current.

## Display has no backlight:

- Contact your authorized MasterCraft dealer.

## Keypad has no backlight:

- Contact your authorized MasterCraft dealer.

**PROSTAR  
VIDEO SCREEN  
OPERATIONS**





The ProStar 11" video touch screen is a multi-functional tool that provides GPS tracking, multi-media display, cruise control, rider profiles, and enables equipment operators to view a wide range of engine, ballast, transmission parameters and service codes.

## CARE AND MAINTENANCE

Only basic cleaning should be required to maintain the 11" video touch screen at its best. A soft cloth can be used for cleaning the unit. Typical window cleaner or rubbing alcohol can also be used to clean the glass portion of the video screen display. To avoid damage that is not covered under warranty, do not use harsh or abrasive cleaners on the unit.

## CAUTION

Avoid contact between sharp or hard objects and the video touch screen because this can result in scratches or other permanent marks on the screen.

## BASIC NAVIGATION FEATURES

All features are easily accessible through the touch point commands and menus.

### Touch Point Commands

After the desired screen is accessed, navigation within the screen is controlled with Touch Point Commands. These are executed by touching the screen in areas that are outlined with a highlighted bezel. In addition, there are areas where sliding a finger up or down can adjust settings. For example, on the Ballast screen, sliding the finger on the inside of the screen tank area adjusts the ballast setting.









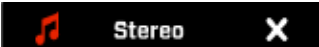

# STEREO

The Stereo screen can be accessed by pressing the  button on the 11" display.



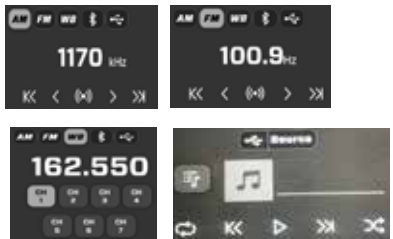

## Touch Point Commands

	<p>Opens the Stereo controls, then becomes . Touch X to close.</p>
	<p><b>SOURCE</b> — Touch this to select a Master-Craft supported stereo source:</p> <ul style="list-style-type: none"> <li>• AM radio</li> <li>• FM radio</li> <li>• Regional Weather Channels (7)</li> <li>• Bluetooth-connected devices</li> <li>• USB drives</li> </ul>

	<p><b>SCAN</b> — These buttons scan to the left or right and will stop on the next available station/song.</p>
	<p><b>FINE TUNE SCAN</b> — These buttons scan to the left or right to fine-tune the current signal.</p>
	<p>Initiates a scan to the next available station where it stops for a few seconds, then scans again and stops for a few seconds, until a complete loop around the stations has occurred.</p>
	<p><b>FAVORITES</b> — One of five buttons to which a favorite station can be saved. Hold your finger on the button until the station address appears as the button label.</p>
	<p><b>MUTE</b> — Touch this button to mute or unmute the volume.</p>
	<p><b>VOLUME</b> — Slide the red dot along the line or touch the line to adjust the volume.</p>
	<p><b>Appears as:</b></p> 

# BLUETOOTH PROCEDURES

To attach a Bluetooth-connected device, follow these steps:

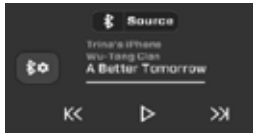
Step	Action
1	Touch the Bluetooth icon  . If the desired device is not already connected, touch the Bluetooth Settings button  .
2	Previously paired devices will appear on the Devices list. Touch Add to add a different device.
3	The Add New Device screen will appear, asking to put the mobile device into pairing mode. Touch OK.
4	The display will begin to poll available devices within the physical area. When the desired device appears in the list, touch the + beside the name.
5	A "Pairing Device" message will appear on both the display and device. Touch Pair on the Device and touch OK on the display.
6	The display will show Connected beside the device name. Touch Back, and the song title and artist currently being played will appear: 

# SWITCHES

Touch the Switches button and the following screen will appear:



Touch the appropriate button (Bilge, Blower, Lights and Heaters) to turn them on or off.

Note: Heater and Seat Heater are options enabled by the Dealer and may not appear on the above screen.

To close the Switches menu, touch the X:



# BALLAST



The Ballast controls can be accessed by pressing the Ballast button. The following screen will appear:



## Touch Point Commands

Utilize the up and down arrows to increase or decrease the Ballast.

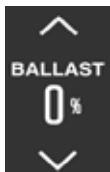

Utilize these buttons to Fill completely or Drain completely the Ballast. The Stop button will appear in mid process to halt at the displayed percentage.



	Touch the X to close the Ballast controls.
	This is a graphical representation of the ballast.
	The blue section represents the current water level.
	The green section represents the amount of water being added (when increasing the Ballast).
	The red section represents the amount of water being drained (when decreasing the Ballast).
	You may touch the specific color section and slide up to fill or down to empty the Ballast.

# ZERO OFF

Zero Off® GPS Speed Control is based solely on input from satellites, engine management systems and the speed you are traveling across the surface of the water. These eliminate the requirements for skier weight, crew weight, KX, PX or even any kind of wind adjustment. You simply set the desired speed and go. This easy-to-use technology has made Zero Off the industry standard.

Simply touch Zero Off to turn it on and adjust your Set Speed with the arrows.



# GAUGE SCREEN

- Speedometer (MPH)
- Water Depth (FT)
- Air Temperature (°F)
- Water Temperature (F)
- Battery Voltage (Volts)
- Fuel Level



4:39 AM 47 °F -0 °F 65.7 Ft 169 F 59 Hrs

The top of the screen duplicates some of the gauge information and also displays the:

- Clock
- Engine Hours



# PROFILES



The Profiles screen can be accessed by pressing . This feature displays rider/user profiles for cruise controls based on user preferences for Set Speed, Ballast, and Tab settings. Up to 20 rider/user profiles can be created and stored.

Touch the available Profiles and slide your finger up to view the complete list.



Touch an existing profile to highlight it, and your choices are Delete, Activate and Edit. The Profile Name, Profile Speed, 3Event Settings and Ballast can be edited for existing profiles. Choose Edit and follow the screen prompts.

## Adding a New Profile

To add a new profile, follow these steps:

Step	Action
1	Touch Add New.
2	Type the Profile Name and touch Next. Verify the name and touch Next.
3	The Edit Profile Speed screen will appear. Choose the appropriate 3Event Event Type (Trick, Jump Tournament or Training, Slalom Tournament or Training).
4	Utilize the - and + buttons to adjust the speed to the desired setting. Touch Next.
5	Choose whether to turn on or off Plus (for additional throttle when entering the first gate) and choose the desired Pull Type. Touch Next.
6	Slide your finger on the Ballast cell or utilize the arrows to adjust the Ballast water level to the desired amount.
7	Review all the settings on the final screen and touch Save.
8	Highlight the newly added profile and touch Activate.
9	The screen will display the activated profile settings and turn on Zero Off.

# TOURNAMENT EVENTS

The 3 Event screen can be accessed by pressing Slalom, Jump or Trick at the bottom of the screen:

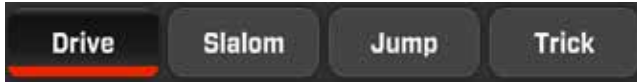

This feature provides a way to keep a boat within the strict guidelines of the event it is tracking and provide a visual display of the track and the progress of the skier.

## Tournament and Training Modes

There are two modes each for Slalom and Jump. Select the Event, then choose Tournament or Training.



The Training Mode operates like the Tournament Mode without the set speed limitation.

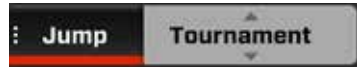

The Tournament Mode is limited to the set speed of the event.

# SLALOM - TOURNAMENT MODE



This screen illustrates the display when the event being tracked is the Slalom event in Tournament mode.



To adjust the Wait Time, touch that field and utilize the - and + buttons on the popup screen.



Allows you to map a course. See [Course Manager](#).

# COURSE MANAGER— ALL SLALOM AND JUMPING EVENTS

On the 3 Event screen, touch the Auto Detect / No Course Active button, and the Course Manager screen will appear.



NOTE: Always highlight a course on the list page before mapping a new course. When mapping a course, the program assigns the mapping to whatever name is highlighted on the course list.

When auto detect is active, you do not have to select an active course. The 3-Event head unit automatically starts the course and timers based on your GPS location when you enter a course. If auto detect is not active, you have to manually select a course you want to follow.

## Course Mapping Instructions

Step	Action
1	Highlight a course to be mapped, then touch  .
2	Press Start Gate to begin mapping the course.  For Slalom, press the Start Gate button when the GPS puck crosses the start gate.  For Jump, press the Start Gate button when the Ski Pylon crosses the start gate.
3	Press End Gate to stop the mapping.
4	If necessary, touch Cancel to cancel the current mapping and return to the course list.

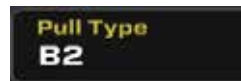

Pull type is the amount of “pull” felt by the skier as the boat adjusts to maintain the set speed.

- A: Slower engine response out of the buoy
- B: Moderate engine response
- C: Faster engine response
- 1: Softer pull behind the boat
- 2: Moderate pull behind the boat
- 3: Harder pull behind the boat



In the On position, the system will react sooner to both increase and decrease in speed deviation.

Used for trick setting or additional throttle when entering the first gate.



# TRICK SCREEN

This screen illustrates the display available when the scheduled event is Trick. Use the Touch Commands in setting up, controlling and tracking the Trick event.

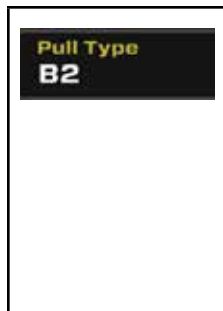

## Touch Commands Description

	Begins the Countdown. Touch Start to begin.
--	---

	Pull type is the amount of “pull” felt by the skier as the boat adjusts to maintain the set speed.  A: Slower engine response out of the buoy B: Moderate engine response C: Faster engine response 1: Softer pull behind the boat 2: Moderate pull behind the boat 3: Harder pull behind the boat
	In the On position, the system will react sooner to both increase and decrease in speed deviation.  Used for trick setting or additional throttle when entering the first gate.



# SETTINGS

Touch the Settings icon  to display the following screen:

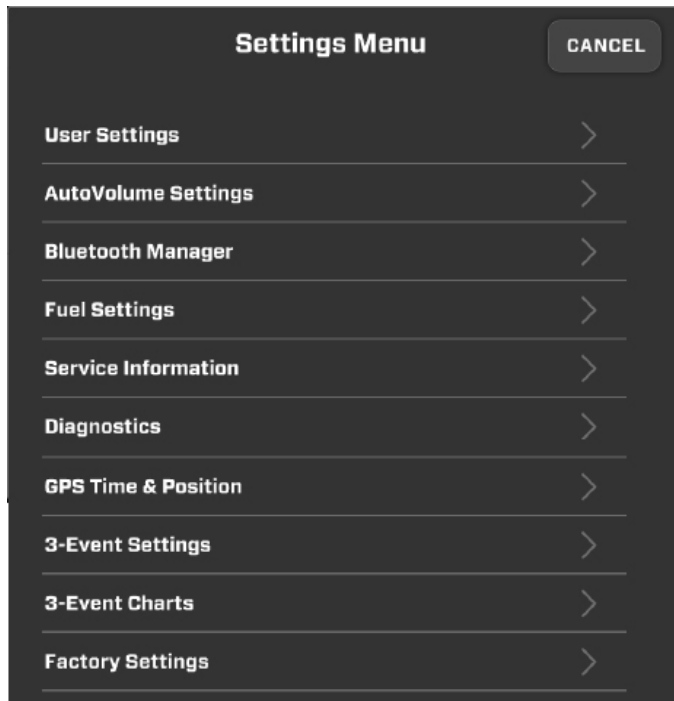

## User Settings

Touch this touch command to access the user settings screens. Touch the field following the option to change the setting. Adjust a scale setting by sliding the red dot along the presented line. Touch [Back] to return to the Settings menu.

Touch Commands	Description
Units	US Standard (US Std) or Metric
Fire Extinguisher Notification	Enabled (Pop-up) or Disabled (Pop-up)
Depth Alarm	Sets the depth at which an alarm will sound when the boat approaches that depth
Day Brightness	Sets the screen brightness for daylight
Night Brightness	Sets the screen brightness for night-time
Gauge Brightness-Day	Sets the gauge brightness for daylight
Gauge Brightness-Night	Sets the gauge brightness for night-time
Ballast Settings	Controls the ballast fill and drain times by utilizing the - and + buttons.

## AutoVolume Settings

Utilize the - and + buttons to adjust the intensity of the volume that occurs automatically to compensate for wind and engine noise.

## Bluetooth Manager

See Bluetooth Procedures in this manual.

## Fuel Settings

The screenshot shows the Fuel Settings interface. At the top, there are 'BACK' and 'CANCEL' buttons. The title 'Fuel Settings' is centered. Below the title, there are two rows of settings. The first row is 'Model: PROSTAR' and 'Fuel Management' with 'DISABLED' and 'ENABLED' buttons. The second row is 'Amount: 0.0 Gal' and 'Fuel Alarm' with a slider set to '0%'. Below this is a numeric keypad for 'Gallons Added?' with a display showing '00.00' and 'Added Value'. There are 'FULL' and 'SAVE' buttons at the bottom right.

Upon startup, the Fuel Management system will ask, “Did you add fuel?” If you answer “Yes”, the above screen will appear.

Touch Commands	Description
Fuel Management	Turns off (Disabled) or on (Enabled) the management of fuel for the craft.
Fuel Alarm	Utilize the - and + buttons to set the remaining percentage of fuel at which an alarm will sound to warn of a low fuel situation.
Gallons Added?	Enter the number of fuel gallons added.
Full	Touch this button if the fuel tank has been filled to Full.
Save	Touch this button to save the settings entered on this screen.

## Service Information



Touch Commands	Description
Software Information	Provides the Software Version, Application Version and Part Number (PN), OS Version and PN, Bootloader Version and PN, ZeroOff Serial Number and Software Version, Prop Type and Engine Type. Also present is a way to update the software through a USB drive.
Dealer Information	This contains the Dealer contact information (provided by the Dealer).
Dealer Service Reset	Set by the Dealer. If changes are needed, contact your Dealer.
Oil Change Reset	Allows the resetting of the Oil Change timer when the Oil is changed.

## Diagnostics

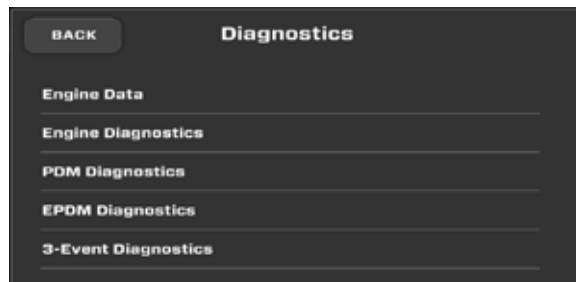

Touch Commands	Description
Engine Data	Displays Engine Hours, Engine Temperature and Oil Pressure.
Engine Diagnostics	Displays Active and Stored Faults (if present) and any Corrective Actions necessary. (See next page for additional information)
PDM Diagnostics	Displays any PDM short circuits, analog out of range, open circuits or over-currents (if present), and a method to reset the faults.
EPDM Diagnostics	Displays any electrical PDM faults and a method to reset them. (See next page for additional information)
3-Event Diagnostics	Displays active and historic diagnostic codes for ZeroOff, and a method to reset them.

# EPDM & Engine Diagnostics

## Models

All ProStar models with standard PV1100 Touch Screen

## Purpose

Power distribution modules (PDMs) provide electrical power to various vehicle systems. They also have diagnostic functionality and can be used to monitor the fault status of circuits. On ProStar models and other MasterCraft boats, the EPDM (Engine Power Distribution Module) is designed to make engine diagnostic checks more convenient, enabling quick, on-the-water fixes.

## Location

To access the EPDM screen, press the Settings button, which will call up the Settings menu. Tap Diagnostics, then tap EPDM Diagnostics.

## Operation

The EPDM screen displays critical engine and electrical system operating information. Amperage draw and the status of internal digital switches are displayed on the EPDM screen for each engine function. Digital switch status is designated by either a green, red or gray indicator.

- A green indicator denotes that the digital switch is functioning properly.
- A red indicator denotes that there is a problem with the digital switch and it has tripped.
- A gray indicator denotes that the digital switch is currently unused or not receiving power.

To reset a tripped digital switch, press RESET next to the system with a fault. To reset the entire EPDM, press RESET ALL on the bottom right portion of the screen.

If a digital switch continues to trip multiple times in one outing, it is a sign of a larger electrical issue and the boat should be taken to an authorized MasterCraft dealer for diagnosis and repair.

**The EPDM and digital switches are designed to protect the engine and electrical system from damage. If a switch has tripped and continues to trip even after resetting the EPDM, it may be a symptom of a larger electrical issue, and the boat should be taken to an authorized MasterCraft dealer for diagnosis and servicing.**

## Active Faults/Stored Faults

Shows the number of active faults and which fault number is currently being displayed. To advance to the next fault, touch [NEXT] and [PREV] to go back to the previous fault. Touching [BACK] returns to the Settings Menu.

- **SPN** – “Suspect Parameter Number” - fault code. If not translated into text by the display, see the engine manufacturer’s literature for the definition of the SPN number.
- **FMI** – “Failure Mode Indicator” - fault code. The FMI is defined by SAE J1939. If not translated into text, see the SAE standard, or the engine manufacturer’s literature.
- **Description Field** – Most common SPN’s and FMI’s have text for the description stored in the display. If there is no text, then this SPN and FMI must be defined by referring to the engine manufacturer, or the SAE J1939 standard.

**NOTE: This field is only used with certain brands and models of engines.**

## Corrective Action (Suggested action for correction):

### Get Faults

Touching [Get Faults] queries the engine(s) ECU for feedback on diagnostic codes that have been activated and stored in the ECU for service needs.

## GPS Time & Position

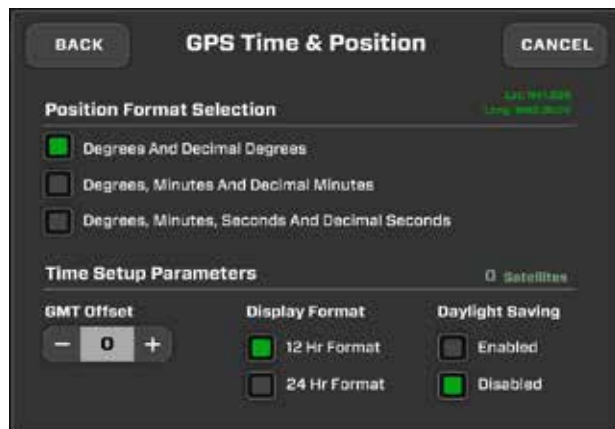

Touch Commands	Description
Position Format Selection	Choose the desired display on the map for your location.
Time Setup Parameters	Displays the number of detectable satellites, along with: -GMT Offset: adjust the number of hours your location is from GMT -Display Format: choose 12- or 24-hour -Daylight Saving: enable or disable

## 3-Event Settings

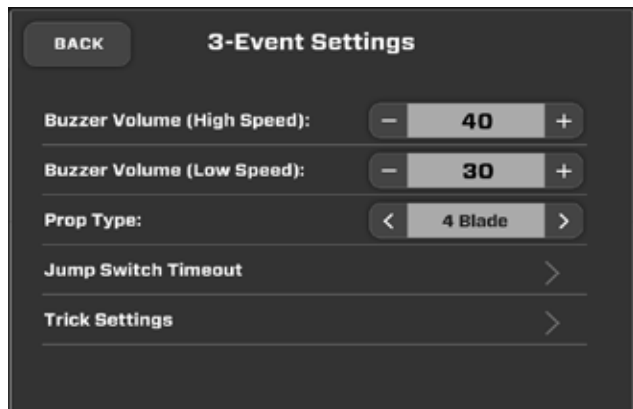

Touch Commands	Description
Buzzer Volume (High Speed)	Adjust the volume of the buzzer that will sound during times of high speed.
Buzzer Volume (Low Speed)	Adjust the volume of the buzzer that will sound during times of low speed.
Prop Type	Choose 3- or 4-blade.
Jump Switch Timeout	(ZeroOff does not recommend changing this option except in extreme conditions.)
Trick Settings	This page enables or disables River Mode, allows the choosing of the River Direction, and the Offset setting.

## 3-Event Charts

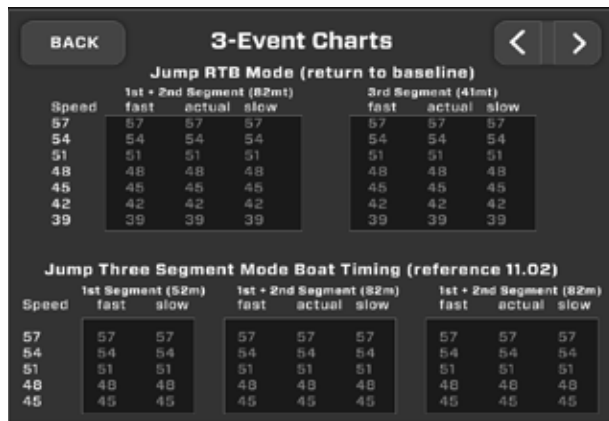

This section provides reference tables of the Slalom and Jump Timing Tolerances.

IMPORTANT: Use the 3-Event Charts for reference only. The charts will not reflect any changes, should a change occur in the rule book. We suggest periodically verifying the charts with the current rule book. Touch the arrows to view the two additional pages.

## Factory Settings

This section requires a Dealer Code to enter. If changes are necessary, please contact your Dealer.

# TROUBLESHOOTING

## **Display appears not to work or doesn't come ON.**

1. Display could be in sleep mode. Touch a key on the keypad to activate the display.
2. Check for loose connections at battery and display unit.
3. Check for reversed polarity on the power connections.
4. Verify battery has a minimum voltage of 6 volts.

## **Display resets or goes OFF when starting engine.**

1. Check display supply wires are connected properly to battery.
2. Verify battery is charged properly.
3. Check battery for efficient starter current.

## **Display has no back light.**

Contact your MasterCraft service center.

## **Display has no keypad back light.**

Contact your MasterCraft service center.

# **NXT OPERATIONS**





# DASH COMPONENTS

## Klipsch Commander Head Unit

(where equipped) with four (4) 7" Klipsch speakers. (See separate, accompanying owner's manual from the manufacturer for details regarding operation and care.)



## Switches



### Blower switch

A two-position switch activates the engine box ventilation blower. Push the toggle switch UP to turn the blower ON.

**NOTE: The blower must operate for a minimum of four (4) minutes before starting the engine at any time.**

The blower must also be operated during idle and slow-speed running, but is not necessary during cruising speed.

**! DANGER**

To prevent a possible explosion, operate the blower for at least four (4) minutes before starting the engine and always when at idle or slow-running speed. Explosive gasoline and/or battery fumes may be present in the engine compartment. Failure to operate the blower as instructed may cause improper ventilation of the boat engine and bilge areas, and fuel vapors can accumulate in this area, causing a fire or explosion which may result in serious injury or death!

### FWD and Aft bilge pump

The bilge pumps will be in the automatic mode when the ignition key is turned ON. The manual and automatic bilge discharge system is never completely OFF. When in the automatic (default) position, a sensor alerts the system to discharge water from the bilge area. Boat operators are advised to leave the switch in the automatic position, unless there appears to be excess water in the bilge. In that event, the bilge pump can be manually activated by turning the bilge pump switch to the manual ON position. Return the switch to

the automatic position when finished emptying the bilge. Leaving the switch in manual mode can result in damage to the pump and may not be covered by warranty.

## CAUTION

Failure to leave the bilge pump switches in **AUTOMATIC** mode can result in damage to the bilge pumps. The pumps will not shut **OFF** while in the **MANUAL** mode until the operator turns them **OFF**. Such damage is not covered under warranty. Malfunctioning pumps or pumps that do not work at all can result in excess water in the bilge, and eventually into the deck. Over time, this could result in sinking of the boat. Such damage is not covered under warranty.

### Navigation/Anchor lights

Push the toggle switch **UP** to turn the lights **ON**.

- Return the toggle switch to **CENTER** (neutral) to turn the light **OFF**.
- Push the toggle switch **DOWN** to turn the anchor lights **ON**.

## WARNING

MasterCraft boats are designed for activities that should be conducted during daylight with good visibility. When operating at night or in limited visibility, turn on the navigation lights and slow down.

In limited visibility it is difficult to see and interpret the running lights of other boats, particularly with lights on-shore that are in the background. Operating at slower speeds gives you the opportunity

to see and be seen by others. Weather conditions during daylight may also result in the need to run or anchor with the lights on. When circumstances require the operation of your MasterCraft boat at night or in limited visibility, activate the navigation lights, ensure that they are functioning and **SLOW DOWN**. Maintain a close watch for the navigation lights of other vessels and objects in the water. Failure to do so may result in serious injury. See the Visual Assistance section of the Boat Operations chapter.

### Underwater lights

This two-position toggle switch is pushed **UP** to turn **ON**, and **DOWN** to turn **OFF**.

### Courtesy lights

This two-position toggle switch is pushed **UP** to turn **ON**, and **DOWN** to turn **OFF**.

## Video Screen and Ballast/Tab Switches



The ballast tanks are filled and emptied by pressing the switches, which are clearly marked by tank designation above the three-position switches. To fill, press the appropriate switch **UP**; to empty, press

the appropriate switch DOWN. The center (or neutral) position is OFF and the pumps are inactive.

**IMPORTANT NOTE: These switch controls and pumps do not operate AUTOMATICALLY! It is important for operators to return the switches to the center (or neutral) position after filling or emptying tanks**

It is possible for operators to be aware when tanks are full as overflow will exit the tanks through the overflow vents. When emptying, operators should pay attention to the vents. When the tanks are empty, water will cease to come out the vents.

## CAUTION

**Maintain ballast switches in the center or neutral positions at all times, except when filling or emptying tanks. Failure to follow this guideline may result in damage to the ballast pumps. Any resultant damages to ballast pumps are not covered under warranty.**

In the event of ballast pump failure, the inability to empty the tank(s) of all water may result in more serious issues. These include unanticipated effects on boat maneuverability; inability to tow the boat; and/or instability while towing the boat due to the increased weight from the filled tank.

### NXT Video Screen

See following section for information regarding operation.

### Horn

The horn is sounded by means of a button on the instrument panel. Pressing the button emits a loud and recognizable noise.

### START/STOP BUTTON

NXT models are equipped with a removable ignition key. Its purpose is for safety and security. The key should be inserted prior to starting an outing, and removed at the conclusion. This is intended to prevent theft or unapproved use of the boat.

The process for starting the boat is:

- Insert the key and turn to the right (starboard). This turns ON the electrical system and prompts the battery(ies) to provide power.
- Turn the blower ON and allow it to run for at least four (4) minutes before starting the engine.
- Momentarily press the ENGINE START-STOP button.
- Momentarily press the ENGINE START-STOP button to turn OFF the engine.

## WARNING

**The electrical system will continue to operate as long as the key is turned. Whenever the engine is stopped, the key should be turned to the left and/or removed in order to prevent depletion of the batteries and inability to start the engine.**

At the conclusion of the outing, turn the key OFF and remove from the key slot. Also, shut OFF the battery switch. Doing so will ensure that you have turned OFF the electrical system, and prevent others from starting or running the boat. Note that shutting OFF the key but failing to also turn OFF the battery switch will result in the electrical charge to the battery or batteries continuing to drain. Such drain will, in time, render the batteries unable to start the engine or run any electrical components on the boat. As noted elsewhere in this Owner's Manual, a dead battery could cause boaters to become stranded.

**Attitude Adjustment Plate and Surf Star System Wake Shaping Devices (when equipped)** The Attitude Adjustment Plate has been designed to improve the overall attitude of a boat. If used properly, the plate will improve the ride, reduce drag, increase speed and improve the fuel efficiency of the boat.

The plate is mounted with the actuator on the transom of the boat. When the plate is lowered, the water flow is redirected, creating an upward force at the stern of the boat. When the stern rises, the bow will lower.

Since the actuator that maneuvers the plate is electrohydraulic, it provides an immediate response at the touch of the switch. The switch adjustments are based on the position of the bow, and are designed in that manner to minimize the guesswork while underway.

Press the switch DOWN to lower the bow. Press the switch UP to raise the bow.

Since models have different weights, lengths, speed and performance, it will take some practice for the operator to

understand how the boat reacts with the attitude adjustment plate installed. The plates will allow your boat to get on plane faster and continue planing at lower speeds. This will improve visibility and the overall safety of the boat. When making adjustments with the attitude adjustment plates, use short momentary taps of the switch. Continued practice will help you become familiar with how the plates perform.

**Surf Star System Wake Shaping Device Switches** Independent switches are provided for each device. Press DOWN on the switch to deploy the tab, and UP on the switch to retract the tab.

Maneuvering a boat with the wake shaping devices deployed requires practice to master. Initial times running with either deployment should be done at low speed and with plenty of room. This is critical to learning how the devices affect control and maneuverability.



**Electrohydraulic actuators provide an instant response. When making adjustments, use short momentary taps of the switch.**

## Special Conditions

**Head Sea:** Lower the plate by tapping slightly DOWN. This will bring the bow down while maintaining speed. This also allows the hull of the boat to absorb the impact of the waves. This adjustment will

result in a more efficient and smoother ride. Changes should be made in small increments to ensure maintaining control of the boat.

**Following Sea:** Make sure the plate is fully retracted by pressing UP. This will bring the plate up to a fully retracted position, decreasing lift in the stern and allowing the bow to rise. If the plate is deployed, the bow may dig.

**Shallow Water/Hole Shot:** Lower the plate completely by pressing DOWN. This provides lift in the stern of the boat and will keep the bow down. As you throttle up and speed increases, raise the tab by pressing UP.

**Uneven Load:** If one side of the boat is higher than the other while running, press DOWN on the switch on that side. This will lower the tab on the listing side (low side) to bring the boat level.

**Porpoising:** To stop porpoising, press DOWN. The plate needs only to be deployed slightly to correct this adverse situation.

following seas or when running an inlet, the plates should be fully retracted. This will allow for optimal performance.



**Electrohydraulic actuators provide an instant response. When making adjustments, use short momentary taps of the switch. Excessively powerful adjustments to the actuators may cause loss of control, which could result in serious injury or death.**



**Use caution when operating adjustment plates. Improper adjustments may cause loss of control, which could result in serious injury or death.**

While the boat is underway do not move one plate up or down significantly as this may cause listing. While at higher speeds do not over-trim, as this will cause the bow to lower quickly, resulting in a reduction of speed and may cause the boat to veer. When in



MasterCraft **NXT**

**NXT20/22/24  
VIDEO SCREEN  
OPERATIONS**





# PRODUCT INFORMATION

The NXT integrates instrumentation and control. The video display is a multi-functional tool that enables the boat operator to view many different display settings, engine parameters, and service codes.



# CARE AND MAINTENANCE

Only basic cleaning should be required to maintain the 4.5" video touch screen at its best. A soft cloth can be used for cleaning the units. Typical window cleaner or rubbing alcohol can also be used to clean the glass portion of the video screen display. Do not use harsh or abrasive cleaners on the unit.

## CAUTION

Avoid contact between sharp or hard objects and the video touch screen because this can result in scratches or other permanent marks on the screen. Clean only with a soft cloth, using window cleaner or rubbing alcohol only. Never use harsh or abrasive cleaners on the unit, as this may result in damage to the unit that is not covered under warranty.

# DISPLAY KEYS AND MENU BAR

Navigate by pressing the Display Keys. The Menu Bar changes according to the screen displayed. To navigate to a feature, press the Display Key under your desired feature or action.



Display Keys

Display Menu Bar

## Display Keys Features And Actions

- Gauges
- Fuel
- MPH
- RPM
- Air Temperature
- Water Temperature (Optional)
- Water Depth (Optional)

## Cruise Control

- ON or OFF
- Set Speed MPH
- Actual Speed MPH
- NXT Wake Shaping Devices Position (Optional)
- Attitude Adjustment Plate Position (Optional)

## Status

- Oil Pressure
- Engine Temperature
- Engine Hours
- Voltmeter

## Tanks/Tabs

- Position
- Attitude Adjustment Plate (optional)
- NXT Wake Shaping Devices
- AutoLaunch (optional)

## Actions

- (Arrow) Scrolls to other screens.
- (Down) Highlights the next setting down. Decreases set speed only on cruise screen.
- (Up) Highlights the next setting up. Increases set speed only on cruise screen.
- (Plus) Increases the setting value or is used to select.
- (Minus) Decreases the setting value or is used to select.
- (Select) Opens the highlighted feature.

# ALARM ICONS

See the illustration below for a demonstration of Alarm Icons in action. You may change the value of the Fuel and Depth alarms from the User Settings screen. Some alarms are set on the Factory Settings screen and require a Dealer Code to access.



#### A = Low Fuel

The fuel in the tank is low and has reached the selected alarm level.

Action: Refuel the vessel

#### B = Low Water Depth

The seawater level is shallow and has reached the selected alarm level. Shallow seawater may cause harm to vessel or vessel may bottom-out preventing safe passage.

Action: Move the vessel to deeper seawater.

#### C = Engine Service

Time for a scheduled engine maintenance or engine oil change. See Service Information for details.

Action: See your local dealer.

#### D = Engine Faults

An engine fault code is present. See Engine Diagnostics for details.

Action: See your authorized MasterCraft dealer for assistance.

# SCREEN FEATURES

## Home

The Home screen can be accessed by pressing the Display Key under HOME in the Menu Bar or press the middle Display Key two times.

**NOTE: The display in this document is set to US Standard Units. You may change it to Metric on the User Settings screen.**

### Home Screen Features:

- Fuel Tank Level
- MPH/KPH – Vessel Speed
- RPM – Engine Speed (Revolutions Per Minute)
- Cruise ON or OFF
- Water Depth (FT/M) (Optional)

To navigate to another screen, press the Display Key under an action in the Menu Bar.

**NOTE: The Water Depth is an option that can be chosen on the Factory Settings Screen. If the option is selected as NO, it is not displayed. A Dealer Code is required to access the Factory Setting screen.**

## Gauge



From the Home screen, the Gauge screen can be accessed by pressing the Display Key under GAUGE in the Menu Bar.

### Gauge Screen Features

- Fuel Tank Level
- MPH/KPH – Vessel Speed
- RPM – Engine Speed (Revolutions Per Minute)
- Air Temperature (°F/°C)
- Water Temperature (°F/°C) (Optional)
- Water Depth (FT/M) (Optional)

Press the HOME key to return to Home screen or press the ARROW key to scroll to other screens.

**NOTE: The Water Depth and Water Temperature are options that can be chosen in the Factory Settings screen. If the option is selected as NO, it is not displayed. A Dealer Code is required to access the Factory Setting screen.**

## Cruise



From the Home screen, the Cruise screen can be accessed by pressing the Display Key under CRUISE in the Menu Bar.

The Cruise screen displays the Following features:

- Cruise ON or OFF
- MPH/KPH – Vessel Speed
- Set Speed MPH/KPH – Determined Vessel Speed When Cruise is ON

Pressing the PRESETS button within the Cruise screen will allow operators to activate a factory built wake profile. Presets exist for:

- SURF LEFT - Set Speed 10.7 MPH
- SURF RIGHT - Set Speed 10.8 MPH
- WAKE - Set Speed 21.0 MPH
- SKI - Set Speed 30.0 MPH

## Status



From the Home screen, the Status screen can be accessed by pressing the Display Key under STATUS in the Menu Bar.

### Status Screen Features

- Cruise ON or OFF
- Oil Pressure
- Engine Temperature
- Engine Hours
- Voltmeter

Press the HOME key to return to Home or press the ARROW key to scroll to other screens.

## Tanks/Tabs



From the Home screen, the Tanks/Tabs screen can be accessed by pressing the Display Key under TANKS/TABS in the Menu Bar.

### Tanks/Tabs Screen Features

- Port NXT Wake Shaping Position
- CTR Attitude Adjustment Plate Position
- STBD (Starboard) NXT Wake Shaping Position
- Cruise ON or OFF
- AutoLaunch ON or OFF
- Enable/disable optional NXT Pro Surf Integrated Ballast Kit

Press the HOME key to return to Home or press the ARROW key to scroll to other screens.



## Main Menu

From the Home screen, the Main Menu screen can be accessed by pressing the Display Key under MENU in the Menu Bar.

### Main Menu Screen Features

- User Settings
- Service Information
- Engine Diagnostics
- Factory Settings

Press the Display Key under the UP and DOWN pointers to scroll the list and highlight a feature. Press the Display Key under SELECT to open a feature screen. Press the HOME key to return to the Home screen or press the ARROW key to scroll to other screens.



## User Settings

From the Main Menu screen, highlight the User Settings feature and press the Display Key under SELECT to open the User Setting screen.

The User Settings allow you to customize display features. To navigate to a feature, press the Display Key under your desired

feature or action. Use the UP and DOWN pointers to scroll the list and highlight a feature. Use the PLUS and MINUS to change value or to select. Press the HOME key to go back; press it again to return to Home.

**Units** - US Standard (US Std) or Metric

**Fuel Alarm** - Sets the percent of fuel left in tank to deploy the alarm. Choices are 1% - 50%.

**Min Depth Alarm** - The choices are OFF or from 1 ft. to 98.5 ft.

**Fire Extinguisher** - The choices are Enable (pop-up notification) or Disable (pop-up notification).

**Factory Reset** - This choice restores all factory settings to their original values. Choices are: YES or NO.

**Day Brightness** - Sets the screen brightness for daylight. Settings are: 1%, 2%, 3%, 4%, 5% and 10-100% in increments of 10%.

**Night Brightness** - Sets the screen brightness for nighttime. Settings are: 1%, 2%, 3%, 4%, 5% and 10-100% in increments of 10%.

**Gauge Brightness - Day** - Sets the gauge brightness for daylight. Settings are: 10- 100% in increments of 10%.

**Gauge Brightness - Night.** - Sets the gauge brightness for nighttime. Settings are: 10-100% in increments of 10%.

The display uses Night Brightness and Gauge Brightness Night when the Nav Light input is switched ON.

## Service Information



From the Main Menu screen, highlight the Service Information feature and press the Display Key under SELECT to open the Service Information screen.

The Service Information screen displays the following features. To navigate to a feature, press the Display Key under your desired feature or action. Use the UP and DOWN pointers to scroll the list and highlight a feature and SELECT to open a feature screen. Press the HOME key to go back; press it again to return to Home.

### Software Version

This screen is an information only screen that provides the following:

- Application version and part number
- Operating system version and part number
- Boot loader version and part number;
- Software version.

### Oil Change Reset

Select YES after an engine oil change to reset the internal clock for oil change alerts. An Oil Change alert is displayed the first time after 10 engine hours. Subsequent alerts are displayed at 50 engine hour intervals.

### Dealer Service Reset

This provides the dealer with the ability to reset the clock. Service is required for the engine every 100 hours. When 100 engine hours has been reached, an alert is displayed to perform maintenance service on the engine.

**NOTE: Access requires a dealer code. If reset is needed please contact your dealer.**

## Engine Diagnostics



From the Main Menu screen, highlight the Engine Diagnostics feature and press the Display Key under SELECT to open the Engine Diagnostics screen.

The Engine Diagnostics screen displays active and stored faults. When you open the Engine Diagnostics screen, the display will query



the engine(s) ECU and provide feedback on any diagnostic codes that have been activated and stored in the ECU for service needs.

To navigate to a feature, press the Display Key under your desired feature or action. Use PREV and NEXT to scroll the fault list. Press ACTIVE FAULTS to toggle to STORED FAULTS. Press the MENU key to go back. Press the HOME key to return to Home.

## Engine Diagnostics Screen Field Definitions

### SPN (Suspect Parameter Number - Fault Code)

If not translated into text by the display, see the engine manufacturer's literature for the definition of the SPN number.

### FMI (Failure Mode Indicator - Fault Code)

The FMI is defined by SAE J1939. If not translated into text, see the SAE standard or the engine manufacturer's literature.

### Description Field

Most common SPNs and FMIs have text for the description stored in the display. If there is no text, then this SPN and FMI must be defined by referring to the engine manufacturer or the SAE J1939 standard.

### Corrective Action

See dealer

### Get Faults

Selecting GET FAULTS queries the Engine Control Unit (ECU) for

feedback on diagnostic codes that have been activated and stored in the ECU for service needs.

### Fault Code Pop-Ups

A fault condition will trigger a pop-up dialog box on the screen describing the nature of the fault.

## FACTORY PROFILES



To activate a factory profile, navigate to the CRUISE tab. Select the PRESETS button. Navigate to and SELECT the profile you wish to activate. The ballast will activate and fill the tanks to their set levels. The tabs will move into position.

To deselect a profile, navigate to the CRUISE tab and select the PRESETS button. DESELECT the profile.

# EPDM & ENGINE DIAGNOSTICS

## Models

NXT20, NXT22, and NXT24

## Purpose

The EPDM is a solid state engine fuse block designed for all MasterCraft boats to make engine diagnostic checks easier and more convenient for quick, on the water fixes.

## Location

The EPDM screen is accessible via the standard NXT Non-Touch Screen. To reach the EPDM screen, press the Menu Quick Access Key to bring up the settings menu. On the settings menu, scroll down to and select EPDM Diagnostics.

## Operation

The EPDM screen displays critical engine and electrical system operating information. Amperage draw and digital switch status are displayed on the EPDM screen for each engine function. Digital switch status is designated by either a green, red or gray indicator.

- A green indicator denotes that the digital switch is functioning properly.

- A red indicator denotes that there is a problem with the digital switch and it has tripped .
- A gray indicator denotes that the digital switch is currently unused or not receiving power.

To reset a tripped digital switch, scroll down to the tripped fault and press RESET FAULT. To reset the entire EPDM, press RESET ALL in the bottom right portion of the screen.

If a digital switch continues to trip multiple times in one outing, it is a sign of a larger electrical issue and the boat should be taken to an authorized MasterCraft dealer for diagnosis and repair.

## CAUTION

**The EPDM and digital switches are designed to protect the engine and electrical system from damage. If a switch has tripped and continues to trip even after resetting the EPDM, it may be a symptom of a larger electrical issue, and the boat should be taken to an authorized MasterCraft dealer for servicing.**

## BALLAST TIMES

From the Main Menu screen, highlight the Ballast Times feature and press the display key under SELECT to change the amount of time it takes to fill or drain a ballast tank.

Use the arrow display keys to scroll to the minute or second of the tank to which a change in time is desired. Adjust the time using the + or – display keys.



## TROUBLESHOOTING

### Display Appears Not To Work Or Doesn't Come On.

- Display could be in sleep mode. Select a key on the keypad to activate the display.
- Check for loose connections at battery and display unit.
- Check for reversed polarity on the power connections.
- Verify battery has a minimum voltage of six volts.

### Display resets or goes OFF when starting engine.

- Check display supply wires are connected properly to battery.
- Verify battery is charged properly.
- Check battery for efficient starter current.

### Display has no back light.

- Contact your MasterCraft service center.

### Display has no keypad back light.

- Contact your MasterCraft service center.

# **BOAT OPERATIONS**



# **BASIC ELECTRICAL COMPONENTS**

# CIRCUIT BREAKERS

## Models

Circuit breakers are a standard feature on all models.



## Purpose

Circuit breakers protect major circuits from damage. Whenever an electrical issue is detected in a circuit, the breaker will automatically “trip,” interrupting the flow of electricity. By preventing short circuits and other electrical hazards, circuit breakers protect onboard electrical systems from taking damage.

On MasterCraft boats, circuit breakers may be adjusted from the main breaker board or from the digital “Diagnostics” menu on the dash touchscreen. Both allow the operator to access various switches which are used to reset tripped circuits.

When it comes to preventing electrical faults, circuit breakers are generally preferable to fuses. Unlike fuses, they don’t have to be replaced after an electrical overcharge occurs. MasterCraft therefore uses thermal circuit breakers and PDM smart breakers for all circuits except those powering the auto bilge pumps. For auto bilge pumps, an MDL fuse (also known as a “slow blow fuse”) is used to prevent locked rotor short circuits.

Only some circuits may be reset from the main breaker board. For circuits controlled by the dashboard touchscreen display, the “Diagnostics” menu operates as a digital switchboard. All other circuits are reset using the main breaker board. (See the “Operation” section for more information.)



## Location

The location of the main circuit breaker board varies depending on the model in question. On NXT and XT models, the main breaker board is located under the dash panel closeout, facing aft. On X and X Star models, the main breaker board is found behind a door in the bow walkthrough. On the ProStar, the main breaker board is found beneath the jump seat.

On all models, there are some breakers (PDM breakers) which are reset using a digital switching system. The operator may reset them from the “PDM Diagnostics” menu on the dash screen, where the status of each PDM circuit is displayed. PDM-powered circuits may also be reset by restarting the battery switch cycle or by pressing the main PDM switches on the main breaker board.

For safety purposes, it is important to make sure that all electrical wiring retains its proper position and routing. If during maintenance or inspection it becomes necessary to remove or reposition any of the engine’s wiring or wire harnesses, verify that the wiring has been returned to its original position and that all harnesses are routed correctly before you attempt to use the boat again. If a wiring clip or retainer breaks, replace it immediately.

## Operation

Two types of circuit breaker—thermal and PDM—are found on MasterCraft boats. Operation method varies depending on the type of breaker that has tripped. Circuits controlled from the dash screen use PDM breakers, and should be reset from the “Diagnostics” screen menu. All other components (except auto bilge) use thermal breakers, and should be reset from the main board.

If a problem develops with one of the non-PDM circuits (i.e. any circuit **not** controlled from the dashboard touchscreen), access the main breaker board and shut off the circuit. Wait one (1) minute. Push the appropriate breaker button and switch the circuit on. If the circuit continues to trip, there is a problem requiring urgent attention from an authorized MasterCraft dealer.

To reset PDM circuits, access the “Diagnostics” menu on the dash screen. Find the toggle for the circuit and reset it. (If the circuit has tripped, the menu will display an orange, red, or yellow icon beside the problematic circuit, depending on the issue encountered.) Allow a few seconds to pass while the digital switching resets. Turn the circuit back on. If the circuit continues to trip, there is a problem requiring urgent attention from an authorized dealer.

**Note:** There are several red PDM switches on the main breaker board. These are the main PDM switches; they control all systems on a given PDM. Use these switches to reset an entire PDM if that PDM displays a fault reading on the screen.



## Troubleshooting

Whenever a breaker trips repeatedly, this indicates a situation requiring prompt attention. You should take the boat to an authorized MasterCraft dealer for service. If you attempt self-repair, MasterCraft is not liable for any resultant damages.

# SINGLE BATTERY



## Models

ProStar and NXT models rely on a single battery.

## Purpose

When properly operated, the battery allows the boat's engine to crank over with immediacy, efficiently supporting the various electrical loads onboard.



## Location

The location of the battery switch varies depending on the model in question. On the NXT, the switch is found under the dash. On the ProStar, it is found under the center jump seat.

## Operation

For normal operation, the battery switch should be placed in the "On" position. This allows the engine and all accessories to receive power, letting the engine run through the alternator to recharge the battery. When transporting the boat by trailer or placing it in storage, one should place the switch in the "Off" position. This will allow the battery to remain isolated from all circuits.

## CAUTION

To avoid damaging the engine's electrical system, do not switch off the battery switch while the engine is running.

If the batteries have no charge, bilge pumps will not operate in manual or automatic mode. This may allow excessive amounts of water into the hull, which can damage or sink the boat. When boats are moored and exposed to the elements, frequently check the battery charge and bilge function to make sure they work.

## Troubleshooting

Because battery needs can vary substantially depending on a number of factors (such as usage, location, and the number of connected electrical components), MasterCraft does not place a specific battery—or batteries—in the boat. The company strongly encourages that you discuss battery options with your authorized MasterCraft dealer prior to purchase.

If purchasing a new battery, note that all batteries must have 800 CCA (cold cranking amps). Any less may result in excessively fast battery discharge; this can leave boaters stranded on the water. To attain proper CCA and avoid potential battery malfunction, MasterCraft recommends AGM spiral cell batteries.

# DUAL BATTERIES

## Models

Dual batteries are available on all models except ProStar. They are standard for X and XT and optional for NXT. If the Advanced Audio Package is selected for NXT, dual batteries are mandatory.

## Purpose

An additional battery helps the boat process heavier electrical loads. This is important for late MasterCraft boats, which—due to their high number of powerful features—can be electrically demanding. The dual battery system allows the engine to crank over with immediacy and support all onboard electrical loads.

## Location

A single switch is used to operate the dual batteries. On the NXT and XT, this switch is found under the dash. On the X and X Star, it is found in the bow walkthrough. (**Note:** If a stern thruster is equipped, there will be a second switch for the thruster battery.)



Battery locations vary by model. On X and XT20/21/25 models, batteries are found in the observer storage. On NXT and XT23/24 models, they are under the aft port cushion.

## Operation

For normal operation, keep the battery switch in the ON position. Use the COMBINE setting only in the event that a battery fails during an outing. When hauling the boat on a trailer or placing it in storage, keep the battery switch in the OFF position.

## Troubleshooting

Because battery needs can differ substantially depending on a number of factors (such as usage, location, and the number of connected electrical components), MasterCraft does not place a specific battery—or batteries—in the boat. The company strongly recommends that you discuss your options with an authorized MasterCraft dealer prior to purchasing a new battery.

If purchasing a new battery, note that all batteries must have 800 CCA (cold cranking amps). Any less may result in excessively fast battery discharge; this can leave boaters stranded on the water. To attain proper CCA and avoid potential battery malfunction, MasterCraft recommends AGM spiral cell batteries.



**Prior to operating the boat for the first time, review the electrical information contained in this manual. Failure to follow basic procedures may result in property damage or personal injury.**

# LOW VOLTAGE BATTERY ALARM

## Models

The low voltage battery alarm is a standard feature on all models.

## Purpose

The low voltage battery alarm protects the engine battery in the event that the stereo is used without the engine and alternator running. By automatically shutting off the stereo and sounding an alarm when the engine battery voltage reaches 11.5 volts or less, the battery alarm prevents total battery drainage.

## Location

The low voltage battery alarm is internal and unseen.

## Operation

If the battery alarm sounds, immediately deactivate the stereo and any other battery-powered systems that may be active at the time. Activate the engine and let it run for several minutes, allowing the alternator to recharge the battery or batteries. This will not work if the battery or batteries possess zero charge.

## **DANGER**

The engine exhaust system emits carbon monoxide, a toxic substance which may cause serious harm if inhaled. For this reason, never run the engine in a confined space or any location that may entrap fumes. You should also avoid running the engine whenever the boat is stationary in calm wind conditions.

## **OTHER ALARMS**

### **Models**

All models feature various alarm systems monitoring oil pressure, engine, and transmission.

### **Purpose**

The alarms take readings from sensors that monitor oil pressure and engine/ transmission temperatures. If an issue is detected, an alarm will sound as a warning to the operator.

### **Location**

All alarms are internal and unseen.

## **Operation**

If the system detects readings outside the acceptable range, the system shuts off the stereo and sounds the alarm for a period of one (1) minute. In this event, return to shore as soon as possible and seek assistance from an authorized MasterCraft dealer.

## **BATTERY CHARGER**

### **Models**

The battery charger is optional for all models.



## Purpose

The optional battery charger repowers the battery and extends battery life while the boat is in storage. It belongs to the triple-stage class of electronic chargers. These chargers are lightweight, silent, and completely automatic. Unlike most automotive chargers, they do not boil off electrolytes from batteries that have undergone proper maintenance and installation.

## Location

The location of the battery charger varies by model. For more information regarding the location of your boat's battery charger, see the "Individual Models" section of this manual.

## Operation

Before charging the battery, ensure that all accessories are off. Also ensure that the cables and mounted LED lights are in good condition. If either of these components are damaged, you should not operate the battery charger until they have been repaired or replaced, preferably by an authorized MasterCraft dealer.

To use, hook the charger up to the battery. The battery charger will automatically shut off when the charge is complete. If necessary, the user can monitor the charge status by observing a set of red and green LED lights on the charger. These indicate when the charger is repowering and maintaining the battery.

If you find that you must remove the battery from the product, always remove the grounded terminal from the battery first. Be sure that the area around the battery is well ventilated while the battery is being charged. Also ensure that the battery terminals are free of corrosion. (See the Scheduled Maintenance section of this Owner's Manual for additional battery information.)

## Troubleshooting

If the battery charger ever appears to malfunction, see your authorized MasterCraft dealer for assistance. The dealer should handle all repair and replacement of battery chargers.



**When charging, batteries generate small amounts of dangerous hydrogen gas. This gas is highly explosive. Keep all sparks, flames, and smoking well away from the area. Failure to follow instructions when charging a battery may cause an electrical charge or even an explosion of the battery, which could result in death or serious injury.**

# 12-VOLT RECEPTACLE



## Models

All models include a 12-volt receptacle. Some may include multiple.

## Purpose

The 12-volt receptacle draws on the boat's electrical system to recharge external electronic devices.

## Location

MasterCraft boats have one (1) or more receptacles. Examine your boat to determine whether there are additional outlets.

## Operation

Before plugging any accessory into the 12-volt receptacle, make sure the device is compatible with the receptacle. If it seems to experience resistance plugging into the receptacle, do not attempt

to force the connection; the device is most likely incompatible. Use of incompatible chargers may harm the boat's electrical system. MasterCraft is not liable for any subsequent damages to the boat's electrical system, the charger, or the external device. The warranty does not cover such damages.

## Troubleshooting

If a connected electronic device does not recharge after the expected period of time has elapsed, verify that the charger is compatible. Also make sure that it is fully seated in the receptacle. If the charger is both compatible and fully seated, yet will not charge, take the boat to an authorized MasterCraft dealer for inspection. This kind of problem is extremely rare.

# IGNITION KEY SLOT

## Ignition Key Slot



## Models

All models feature an ignition key slot.

## Purpose

The ignition key activates the boat's electrical system. It is essential that the activation of the electrical system occur prior to engine activation. For this reason, the ignition key is used to power on the electrical components before the engine starts.

The ignition key also promotes safety and security. Since the ignition key is required in order to start the engine, removing it from the boat after each outing will reduce the chances of theft. In this way, the ignition key acts as an additional safeguard.

## Location

Depending on the model, the ignition key slot may be found on the dash or driver's arm rest. Consult the "Individual Models" chapter of this Owner's Manual for further information.

## Operation

Insert the ignition key into the ignition slot. You will notice that there are two positions for the key: "Off" and "On." Turn the key to the "On" position. Then—before activating the engine—run the blower for at least four (4) minutes. Unless necessary, you should never leave the ignition switch in the "On" position for any extended period of time without the engine running, as this will discharge the battery.

## Troubleshooting

If the key will not turn in the key slot, make sure that you have inserted the right key.

If the key turns but you receive no power, the battery or batteries might not have enough charge. Check the voltmeter for a reading. If the charge is under 11.5 volts or does not register, the battery needs charging. Use the charger supplied with the boat.

### CAUTION

**Do not attempt to jump start the battery or batteries from a vehicle or another boat. Doing so may overload the boat's electrical system, resulting in significant damage to the boat. This holds true regardless of battery brand. The warranty will not cover damages resulting from an attempted jump.**

# IGNITION START-STOP



## Models

All boats feature an ignition start-stop button.

## Purpose

The start-stop button is used to activate the engine after the ignition key has powered up the electrical system. The ignition start-stop button is also used to turn the engine off.

## Location

The ignition start-stop is found on the dash or driver's armrest.

## Operation

The process for starting the boat is:

- Insert the key and turn. (This turns ON the electrical system and prompts the battery(ies) to provide power.)
- Turn the blower ON and allow it to run for at least four (4) minutes before starting the engine.
- Momentarily press the engine START-STOP button.
- When it is time to turn the engine OFF, press and hold for three (3) seconds the START-STOP button. If the button is held for less than three (3) seconds, the engine will not turn OFF. This is a system design to avoid shutting off the engine if the button is inadvertently pressed or hit during operation.

## Special Attention

This button affects only the engine. The electrical system will continue to operate as long as the key is turned ON.

If the key is left turned in the ON position after the outing, it will eventually run down the battery(ies) and the engine and all systems will not start as a result.

At the conclusion of the outing, turn the key to the OFF position and remove from the key slot. Doing so will ensure that you have shut down the electrical system, and it will prevent others from starting or running the boat.



## Troubleshooting

If the key switch is in the ON position and the engine will not start by pressing the START-STOP BUTTON, check the voltmeter for a reading. If it is lower than 10.5 volts or does not register, the battery(ies) require recharging. Use only a MasterCraft battery charger. DO NOT attempt to jump start the battery from a vehicle or another boat because this can cause an overload of the electrical system.

# ENGINE EMERGENCY SAFETY STOP SWITCH



**DANGER**

The safety switch lanyard must be attached to the operator whenever the engine is running. Attempting to override this system may result in death or serious injury!

## Purpose

The engine emergency safety stop switch, which is attached to a lanyard, is an ignition cut-off switch designed to stop the engine in the event the operator is thrown or moves away from the helm. The lanyard is equipped with a hook on one end that should be attached to your clothing or PFD, and the opposite end has a slide that fits over the ignition switch. Be sure that the slide is firmly attached to the ignition switch before starting the engine.

## Location

The engine emergency safety stop connection is located near the throttle control box on the armrest. If the slide is left off or is loose, the engine will crank but will not start. Operators should NEVER attempt to override this safety system!

## Troubleshooting

If the lanyard between the engine emergency safety stop becomes unattached from the connection point, the engine will shut down. Reattach the engine emergency safety stop and restart the engine.

# OPERATIONAL CONTROL

## Shift/Throttle Control



### Models

The shift/throttle control is found on all models.

### Purpose

The one-hand, single-lever control doubles as both a gear shifter and a throttle stick. The operator may also use the shift/throttle control to direct the stern thruster and rotate the boat. (For more information on stern thruster operation, refer to the section on the stern thruster in the chapter “Below Deck.”)

### Location

The shift/throttle control lever is located on the starboard side panel, adjacent to the driver's compartment (helm).

### Operation

The lever can be moved from neutral only by raising the lifter under the ball knob. Shifting is accomplished by moving the lever forward or backward. Center (straight up) is neutral. Moving the lever forward engages the running gear; moving it back from center puts the drive train into reverse.

**Never attempt to shift without the engine running!** The neutral safety prevents the boat from starting the engine while in gear, but shifting while the engine is OFF will cause accelerated wear of the shifting gears.

**SPECIAL NOTE:** During regular warm-up of the engine, it is possible to temporarily increase the engine RPMs without moving the boat. To accomplish this, push in the button located at the bottom of the shift/throttle lever with one hand and pull up the “umbrella” (aluminum surround below the top of the knob). Move the lever to the desired position and then simultaneously release the button and umbrella. The engine will run with increased RPMs and can be increased or decreased by moving the lever. Returning the handle to the neutral position will bring the system back to neutral and reduce the engine RPMs to preset levels.

This function should be done sparingly. Over-revving the engine for any extended period can cause undue wear and tear on the engine. Avoid advancing to wide-open-throttle and holding the RPMs at that level.

## **Troubleshooting**

If the shift/throttle lever will not move, be certain that the lifter under the ball knob is lifted up before attempting to move the lever forward or aft. If the lever still will not move, contact your authorized MasterCraft dealer.

Never attempt to shove or force the lever. If it does not move smoothly when operated as indicated, there may be an issue involving the system that requires correction in an area under the deck, which is inaccessible to the consumer.

**ADDITIONAL  
SAFETY  
SUPPORT**

# FIRE SUPPRESSION AND EXTINGUISHING



See also the Safety section of this Owner's Manual.

## Models

All



**Opening an engine compartment when there is indication of a fire inside can cause the fire to flare up and/or spread, which may result in serious injury or death to people onboard.**

**Never attempt to fight a fire with your hands, feet, clothing, or other material onboard the boat, other than approved fire**

**suppression or fire extinguishing products as specified by MasterCraft. Failure to follow directions as outlined in this section can result in serious injury or death.**

## Purpose

MasterCraft has developed an extensive fire suppression and extinguishing system for its boats. All MasterCraft boats are equipped with an automatic fire suppression system. The automatic system operates from sensors in the engine room and will automatically release a clean-agent, gaseous chemical that does not leave residue behind. All boats have also been specified to carry a hand-held 2.5 lb. monoammonium phosphate expellant (dry chemical) unit, which is rated Class A (trash, wood and paper), Class B (UL Approved) and Class C (energized electrical equipment). These units should be used in situations other than engine compartment fires.

Hand-held units should be replaced or recharged as soon as possible after use, or after 12 years from the date of manufacture. In the event of any evidence of a fire within the engine compartment, **DO NOT OPEN THE ENGINE COMPARTMENT (BOX)**. Opening an engine compartment when there is indication of a fire inside can cause the fire to flare up and/or spread, which may result in extensive damage or even sinking of the boat and/or serious injury or death to people on board. Shut down the engine and blowers. Continuously discharge the entire contents of the fire suppression unit immediately.

## Location

*Automatic Fire Extinguishers:* All automatic fire extinguishers are located in the engine compartments on all boats. The locations of automatic fire suppression override units' manual override varies by model, but generally is in the vicinity of the helm.

*Manual Fire Extinguishers:* Manual fire extinguishers have various locations within the boat, but are generally located under either the observer seat or in the head and all are easily accessible. Be certain to determine the location of all fire suppression and extinguishing units on the boat. Your authorized MasterCraft dealer can assist you.

## Operation

*Automatic Fire Extinguisher Manual Override:* It is possible to manually override the HFC-227 fire extinguishing system on all non-CE packaged boats. Pull the pin from the red handle labeled FIRE near the helm seat. Pull up on the FIRE handle to deploy the system.

*Manual Fire Extinguishers:* Pull the pin and squeeze the trigger.

## Special Attention

In case of an engine compartment fire, shut down the engine and blowers before manual discharge, or immediately following the automatic discharge. Boats are equipped with a discharge indication light at the instrument panel or on the video display gauge at the helm.



**DANGER**

**Following the activation of the automatic fire suppression system or a hand-held fire extinguisher, a careful determination should be made as to whether the boat can safely be operated. If there is any doubt or concern whatsoever, the boat should be towed to shore and/or dock for service by an authorized MasterCraft dealer prior to operating again. Failure to follow these instructions could result in death or serious injury/illness.**

## Troubleshooting

- If there is evidence of fire in the engine compartment of a V-drive boat and the automatic fire suppression system does not activate, pull the manual override (on domestic boats only). The override location is illustrated in the Guide to Individual Models of this Owner's Manual. Boat owners should also confirm this location with the assistance of an authorized MasterCraft dealer.
- If the manual override does not deploy, ensure all persons on-board are equipped with PFDs (personal flotation devices). If there is time, send visual and sound signals of the emergency. All persons should abandon ship and move to a safer location. Boats can be consumed by fire and even explode if there are fuel fumes.

- If a fire begins in another location other than the engine compartment, remove the fire extinguishers from their storage location,
- Activate them as indicated above and attempt to put out the fire. Remain alert to the fact that a fire near or in the fuel tank or fuel lines is especially dangerous. Follow the instructions in the preceding paragraph, if a fuel fire begins or if the fire extinguisher(s) has not been effective in putting out the fire.

## CLEATS



### Models

All

### Purpose

Cleats are an important feature of MasterCraft boats. The cleats allow boaters to tie-up to docks with ease and confidence.

## Location

Cleat locations vary by model. (See Guide to Individual Models in this Owner's Manual to determine the locations for your model). Cleats will be on top deck sides of the bow, and aft near the transom. Some larger models also have mid-ship cleats.

## Operation

Use marine-grade lines to loop over the cleat and tie up to the dock, allowing some slack in the rope. If there is any motion in the body of water, MasterCraft recommends also purchasing “fenders” from an aftermarket supplier to provide a cushion between the boat and the dock. Without a cushion, the boat's finished gel coat and graphics can be damaged. Such damage is not covered under warranty.

## CAUTION

The boat should be tied to docks with marine-grade lines **ONLY** to the cleats, allowing some slack. Never tie-up the boat to the tower, mirror, seats or any other part of the boat. If the ability exists to tie up to all cleats on the side nearest to the dock, operators should do so. MasterCraft also recommends using fenders to cushion the side of the boat in the event of water motion. Otherwise, the boat gel coat and graphics may be damaged. Such damage is not covered under the warranty.

# HORN

## Models

All

## Purpose

The horn allows the boat operator to alert other boaters by way of a well-known and loud sound.

## Location

The horn is sounded by pressing a button mounted on the instrument panel or driver's armrest. It is a red button.

## Operation

Press the horn button to emit a loud horn sound as a warning.

## Troubleshooting

If the horn does not sound, check the main circuit breaker panel to see whether the circuit has tripped and needs to be reset. If the circuit does not require resetting, there may be an issue elsewhere in the system. Take the boat to an authorized MasterCraft dealer for repair.

# MIRRORS

## Models

All models feature a standard rear-view mirror. In addition to the standard mirror, two additional optional rear-view mirrors are available, each designed in a different style.

## Purpose

The mirror allows the boat operator to see behind the boat. While mirrors are helpful to assist in the observation of persons being towed behind the boat, a mirror is not a substitute for an observer. Whenever there is a rider behind the boat, the operator must also have an observer facing aft and alerting the operator when the rider is no longer riding on the water or the tow has been lost. There are specific hand signals for activities, and this information is available via U.S. Coast Guard pamphlets and website.

## Location

Mirrors are mounted on the windshield extrusion (metal frame).

## Operation

Most mirrors require no special instructions. They are removable and adjustable up and down and side to side like a standard automobile rear-view mirror. The billet panoramic mirror functions



differently than other mirror options. It uses two locking mechanisms to lock the position of the mirror. To lock in place, turn the lock knob to the marked lock position, the release button will pop out. To unlock, push the black release button and the lock knob will spring open. Raise or lower the mirror, and re-lock it in place.

Each operator should adjust the mirror to a comfortable viewing angle based on his or her height for maximum visibility.

## Special Attention

MasterCraft recommends boat owners and operators use only MasterCraft installed mirrors. While there are a number of third-party mirrors available through marine retailers, the mirror provided by MasterCraft was selected and developed to maximize the range of vision for the driver of MasterCraft boats. If it becomes necessary to replace a mirror, use only MasterCraft approved mirrors.



## Troubleshooting

If a mirror does not stay in place after it has been adjusted to the driver's comfort, verify that the hardware holding the mirror in place is secure. If the driver's vision is obscured, be certain that the mirror is clean. Fingerprints, sun tan oil and a host of other products often used in boats can cause the mirror's surface to become dirty, which can negatively affect the driver's vision when using the mirror. Clean mirrors properly, as described in the Care and Maintenance section of this Owner's Manual.

### CAUTION

**Prior to operation of the boat, verify that the mirror hardware is secure. Failure to do so may result in the mirror detaching from the windshield extrusion. The mirror could hit the operator or a passenger, resulting in injury.**

## SKI/WAKEBOARD/SURF ROPE

### Models

May be purchased from an authorized MasterCraft dealer or after-market retailer.

## Purpose

MasterCraft boats are equipped with watersports towing points as standard equipment, and may also offer other optional pylons and towers intended to be used to attach rope for skiing, wakeboarding, and/or surfing. Note that tow ropes should never be attached to anything but the approved transom tow hook, pylon, or tower.

Care should also be taken by all on board to pay attention to the tow rope because it can snap back and hit passengers when a skier or wakeboarder lets go of it. Usually, the rope simply skips along the water surface behind the boat, but it can become airborne, especially if it was taut prior to release.



**Attach ski/wakeboard ropes to approved pylons and towers. Failure to do so may result in structural failures which could cause death or serious injury.**



**Ski/wakeboard tow ropes may snap back into occupied portions of the boat, causing serious injury. Occupants must be vigilant when towing skiers or wakeboarders.**

## Location

Attachment locations vary by model. See the Guide to Individual Models section in this Owner's Manual to determine pylon and tower attachments for each model.

MasterCraft recommends stowing rope when not in use. Feet, arms, and bodies can become entangled with rope left on the deck or seating; rope left loose behind the boat can become airborne and swing around to strike people on board.

## Operation

Failure to properly and securely attach to the tower, pylon, or other MasterCraft designated attachment locations for each model could result in the rope coming loose. As noted in the above warning, individuals could be injured if the rope is not secure.



**BELOW DECK**

# BILGE SYSTEM, CENTER DRAIN, TRANSOM DRAIN PLUGS, SEA STRAINERS AND SCUPPERS



## CAUTION

Bilge pumps will not operate in either the manual or automatic mode if the batteries are fully discharged. This condition may allow excessive water into the hull, which can damage or sink the boat. Make frequent checks of battery charge and bilge pump function when boats are moored and exposed to the elements.

## Models

All

## Purpose

Water inevitably intrudes into any boat. MasterCraft boats are designed to expel the water via the bilge system. When on the water, bilge pumps will expel water. Bilge pump sensors allow the system to pump water overboard either automatically or manually. Because the bilge is located in the lowest portion of the boat's hull, it is not always readily apparent to individuals on-board whether there is water in the bilge or not. To allow operators the opportunity to manually verify water levels in the bilge, a center access plate or access door is built into every boat.

All boats (except ProStar) have two drain plugs, which allow water to be drained from the boat when the boat is OUT of the water. There is a center T-handle drain (the only one for a Prostar) and a transom drain plug. When out of the water, on a trailer or lift, water can normally be drained into the bilge system by opening the center drain.

Boats have sea strainers installed to assist in keeping debris out of the engine and water intake systems such as the ballast system.

## Location

The bilge lines and pumps are beneath the decks. The center drain location will vary slightly by model, but generally is found close to or adjacent to the driver's seat. It will be accessed through a hatch or access plate, which may be under marine carpet. A transom drain plug is on the centerline of the transom. Sea strainers are located in front of the engine and can be accessed by removing the trans-

mission cover on all engine models. Scuppers, where equipped, are located on the lowest point of the deck, under the rear seats. Bilge pump-out locations are on the side of the boat. Depending on the model, the pump-out may be on the bow or the gunnel. See Guide to Individual Models in this Owner's Manual to determine the location of bilge pump-out. (They are often adjacent to ballast overflow/vents.) Pump-outs should never be obstructed.



The bilge system operates automatically, but can be manually controlled by a digital switch in the accessory page of the Dual Screen Dash. The bilge pumps on all V-drive models will be in the automatic mode when the ignition key is turned ON. Some models may have two (2) switches, one for the forward bilge and one for the aft. In these instances, the switches will be marked on the screen. The manual and automatic bilge discharge system is never completely OFF. When in the automatic (default) position, a sensor alerts the system to discharge water from the bilge area.

Boat operators are advised to leave the switch in the automatic position, unless there appears to be excess water in the bilge as viewed through the center plate. In that event, the bilge pump can

be manually activated by turning the bilge pump switch to the manual ON position. Return the switch to the automatic position when finished emptying the bilge. Leaving the switch in manual mode can result in damage to the pump and may not be covered by warranty!

## CAUTION

**Return the bilge switch to automatic any time it has been turned to manual to remove water from the bilge. Operators should monitor the water level through the center drain and ensure that the bilge pump(s) does not continue to operate after the bilge is emptied. Note that a small amount of water in the bilge is acceptable, except when winterizing the bilge system. Failure to follow instructions may result in damage to the bilge system, which may not be covered under warranty!**



Drain plugs should be loosened and removed when the boat is out of the water to allow additional drainage of the bilge system. Always ensure that the transom drain plugs have been tightened in place prior to launching the boat into the water. Failure to do so can result in water intruding and overwhelming the system, sinking the boat.

## **WARNING**

Transom plugs should be opened only when the boat is ashore. Removing the plugs allows additional drainage of the bilge system. The transom plugs must always be secured tightly in place prior to launching the boat into the water. Failure to do so will allow water to intrude into the bilge system and may result in serious injury or death as a result of the boat sinking.



Center drain pie-hole lids should be secured prior to boat operation. It is possible to misdirect and cross-thread the pie-hole when reinstalling. Retry until the lid is secure, level with the deck. Not only can additional water from the deck intrude if the lid is not secured, but individuals on-board may injure themselves if they misstep in the area of the center drain.

The sea strainer should be checked before each outing. See the Care and Maintenance section of this Owner's Manual for details on how to properly inspect it. As equipped, the strainer operates automatically and does not require a switch or gauge to monitor. Regular maintenance however is important.



**SPECIAL NOTE:** Because the bilge pump operates even when the boat is shut OFF to prevent excessive water on board, if the pump runs fairly frequently, which causes the battery(ies) to fully discharge. This is a signal that the boat is either taking on too much water from a leak or that the boat is being left in the water for periods that are too long. Anytime the battery is low or discharged, properly recharge it prior to operation.

Bilge pumps will not operate in either the manual or automatic mode if the batteries are fully discharged. This condition may allow excessive water in the hull, which can damage or sink the boat. Make frequent checks of the battery charge and bilge pump function when the boats are moored and exposed to the elements.

## Troubleshooting

The bilge system is among the most important systems in the boat. Attention should always be paid to proper operation.

- If the boat does not automatically pump water out of the system when the ignition key is ON, verify that the bilge switch is set to automatic.
- If it is set to automatic but still is not pumping when there is evidence of water in the bilge, turn the pumps on manually using the on-screen button. Follow the instructions above and do not leave the switch turned to manual after water is evacuated.
- If the bilge pump(s) still does not work when turned to manual, check the circuit breaker panel to ensure that electricity is moving between the switch and the pump. If the circuit breaker, which is marked, has tripped, reset it to ON.
- If the bilge pump(s) still does not work, it may be evidence of debris in the system or failure of the pump's impeller, which must be replaced on a regular basis as detailed in the Care and Maintenance section of this Owner's Manual. This is a serious concern. The bilge system keeps the boat from filling with excess water that may cause imbalance in the boat's trim. Under the worst possible conditions, the boat can sink. If the system fails while on a body of water, return to shore IMMEDIATELY! Have all people on-board put on PFDs (personal flotation devices). Signal for emergency help. If persons on-board have working cell phones,

contact help. After returning to shore, take the boat to an authorized MasterCraft dealer as soon as possible for repairs and do not use the boat again until it has been properly repaired.



**An inoperable bilge system can result in the boat taking on excessive amounts of water, resulting in significant damage to the boat, even sinking. Persons on board should wear PFDs and be prepared to abandon ship if the boat is on an outing. Operators should signal for emergency help and return to shore IMMEDIATELY and have the boat repaired. Failure to follow instructions can result in serious injury or death.**

## UNDERWATER EXHAUST

### Models

The underwater exhaust system is a standard feature on X models.

### Purpose

By sending exhaust directly into the water, this feature significantly reduces the amount of noise generated by the boat's inboard exhaust system. As a result, passengers can enjoy music and hold conversations without having to raise their voices over the sound



of the exhaust system. The feature also reduces engine backflow, heightening engine reliability and performance.

## Location

The exhaust tip is found on the stern of the boat.

## Troubleshooting

The underwater exhaust system should be routinely inspected for leaks. Any serious damages to the underwater exhaust or adjacent components should be repaired by an authorized MasterCraft dealer. For more information on exhaust maintenance, please see the “Care and Maintenance” section of this manual.

### DANGER

Exhaust system leaks may allow excessive amounts of water into the boat. This can damage or sink the vessel. Have any leaks promptly repaired by an authorized MasterCraft dealer.

# BLOWER SYSTEM

## Models

All models have a blower system.

## Purpose

The blower system is one of the most critical systems on the boat. A natural by-product of operating the engine is the creation of unseen fumes. Carbon monoxide is discussed in the Safety section of this Owner's Manual. The engine will also create flammable, ignitable gasoline and/or battery fumes. Dispensed into the open air, they are quickly diffused and pose little to no threat to well-being. However, if the fumes are not released by opening the engine compartment and operating the blower for a minimum of four (4) minutes before starting the engine (even if the engine has not been operated for some time), the fumes may explode when the engine is started.

### DANGER

To prevent a possible explosion, the blower will automatically run for four (4) minutes when the key switch is turned to the ON position. You should always operate the blower for at least four (4) minutes before starting the engine and always when at idle or slow running speed. Explosive gasoline and/or battery fumes may be present in the engine compartment. Failure to operate the blower as instructed may cause improper ventilation of the boat engine and bilge areas, and fuel vapors can accumulate in this area, causing a fire or explosion which may result in serious injury or death!

## Location

The blower system is mostly unseen by those on-board. The system operates automatically when the key switch is turned to the ON position, however the blower can be turned on through the Dual Screen Dash. Navigate to the accessory page and toggle the blower ON an OFF. The engine compartment blower exhausts fumes through vents located on the transom of the boat

## Operation

*X and XT Series, XStar:* The blower automatically activates and runs for four (4) minutes when the key is turned to the ON position. To turn the blower on manually, navigate to the accessories page on the Dual Screen Dash. Tap the button to toggle the blower ON and OFF.

*ProStar:* Turn the switch to the right to turn the blower ON. Turn the switch to the left to turn the blower OFF.

*NXT:* Flip the toggle switch up to turn the blower ON. Flip the switch down to turn the blower OFF.

**NOTE: Blower operation drains energy from the battery.**

**SPECIAL NOTE: The blower must operate for a minimum of four (4) minutes before starting the engine at any time. The blower must also be operated during idle and slow-speed running, but is not necessary during cruising speed.**



## Troubleshooting

**NEVER OPERATE THE BOAT IF THE BLOWER SYSTEM IS INOPERABLE OR NOT WORKING PROPERLY. SEE THE DANGER WARNING ON THE PREVIOUS PAGE.**

The blower hums audibly when it is operating. If it is not functioning, turn the ignition key to ON and verify on the voltmeter that the electrical system is charging at least 11.5 volts or higher. If it is not, it will be necessary to recharge the battery(ies). See the electrical information in this section of the Owner's Manual for proper procedure. If there is sufficient charge indicated, but the blower still is not operating properly, **DO NOT LAUNCH THE BOAT.** Take the boat to an authorized MasterCraft dealer for repair.

# STEERING SYSTEM

## Models

All

## Purpose

The steering system controls the direction in which the boat moves.

## Location

Except for the steering wheel and shift/throttle control at the helm, the steering system is not visible under normal circumstances. In a V-drive boat, the steering mechanism is typically located on the starboard side of the engine compartment for models equipped with a cable system, and on the port side for hydraulic steering systems.

To lubricate the control mechanism on the standard system as part of the annual maintenance (as described in the Care and Maintenance section of this Owner's Manual), locate the specific connection for your boat.

Steering wheels are mounted on a tilt mechanism that allows adjustment of the steering wheel angle to meet the needs and comfort of the operator. The system was designed to be used by operators who are sitting down in the driver's seat. Standing or manipulating the steering wheel in any other manner could cause loss of control.



## WARNING

**For most activities the boat operator should be seated at the helm position. Some situations may require standing at the helm to maintain visibility over the bow. When standing is necessary make certain that the safety shut off lanyard is attached to your clothing or PFD. Operating the boat while standing may result in a loss of control which could cause serious injury or death.**

## Operation

The steering of a boat is very similar to that of a car or truck, but it will generally respond less quickly due to operation in the water, which is more dense than air. Read the Starting and Basic Operations Information and Operational Hints that appear in the Preparation section of this Owner's Manual for more detail and assistance.

## Troubleshooting

At any time, if the steering is sluggish, difficult, or shows any signs of not working smoothly and properly, the boat should immediately be taken to an authorized MasterCraft dealer for attention.

Optional hydraulic steering components are not accessible to consumers for repair or maintenance, all of which should be done by an authorized MasterCraft dealer. Most standard steering system repairs are only accessible by the dealer.

# DOCKSTAR HANDLING SYSTEM

## Models

Optional on all X Series, XT Series, NXT Series and XStar models.

## Purpose

The DockStar Handling System controls the direction in which the boat moves. The triple rudder system gives more control over the boat than a traditional single rudder system alone. The DockStar rudder allows a boat to reverse to either direction dependent on the orientation of the steering wheel. A DockStar equipped boat is also more agile and responsive at speed in forward.

## Location

The DockStar Handling System is a triple rudder system mounted to the bottom of the hull. Additional steering components are mounted under the helm and under the engine in the engine compartment.

## Operation

Steering a boat with the DockStar Handling System is very similar to steering a car or truck, but the boat will generally respond slower due to operation in the water, which is more dense than air. A DockStar equipped boat will respond with more precision in forward, at both low and high speeds, than a traditional inboard single rudder system. In reverse, the DockStar system will allow the boat to reverse in either direction similar to a car. As in a car, turn the wheel to the left to back up to port, and turn the wheel to the right to back to starboard.



## Troubleshooting

At any time, if steering is sluggish, difficult, or shows any signs of not working properly and smoothly, the boat should immediately be taken to an authorized MasterCraft dealer for attention. The DockStar Handling System is not accessible to the consumer for repair or maintenance. All maintenance should be done by an authorized MasterCraft dealer.

**Always check your surroundings when using the DockStar Rudder System in reverse, and never approach a person in the water in reverse. Always clear the area of downed riders or swimmers before using the DockStar Rudder System in reverse.**



**DANGER**

**PROPELLER(S) MAY CAUSE SERIOUS INJURY OR DEATH. Shut off the engine(s) when near persons in the water, or on sunpads, swim platforms or the boarding ladders.**

# STERN THRUSTER

## Models

The stern thruster is an optional feature for all X models.

## Purpose

The stern thruster propels the stern of the boat clockwise or counterclockwise, allowing the operator to easily and expediently rotate the vessel. This is useful for circumstances which require close maneuvering, such as docking the boat under heavy wind resistance or navigating tight, narrow lanes.



## Location

The stern thruster is mounted to the stern of the boat, directly beneath the swim platform. A grated tunnel encloses the propeller. The thruster knob—used to activate and direct the propeller—is found at the top of the throttle control lever in the helm.

## Operation

The stern thruster may be operated in forward, neutral, or reverse. To use the thruster, simply rotate the twist knob located at the top of the throttle control lever. The stern thruster will automatically activate as soon as the knob is twisted, causing the propeller to rotate the boat in the direction chosen.

To lessen the drain placed on the engine battery, the stern thruster has its own dedicated battery. The thruster battery is located in the observer compartment and may be switched on and off using the corresponding battery switch, which is found in the walk-through leading to the bow.

## Troubleshooting

If the stern thruster is unresponsive, make sure the dedicated thruster battery switch is in the ON position. If the stern thruster battery is active, yet the stern thruster still fails to respond, use the touchscreen diagnostics menu to reset the circuit. The thruster is connected to PDM 3 and should be reset from the corresponding page within the diagnostics menu. If none of these procedures fix the problem, consult an authorized MasterCraft dealer.

# SALT WATER ANODE

## Models

All except ProStar, as part of the Salt Water Package option.

## Purpose

If the boat is operated in salt, polluted, or brackish waters, even temporarily, the boat should be equipped with a transom-mounted aluminum anode to protect submerged metal parts.

The aluminum is, by design, self-sacrificing. It is slowly eroded away by electrolytic action and requires periodic inspection for deterioration. When the aluminum has eroded to approximately one-half (1/2) of its original size, it must be replaced to continue protection, or damage to other metal parts may result.

## Location

The anode is mounted on the transom.

## Operation

There is no operation required. Boat owners should periodically examine the anode to determine how much erosion has occurred and consult an authorized MasterCraft dealer to determine the appropriate time to replace it.





# VISUAL ASSISTANCE



# NAVIGATION/ANCHOR LIGHTS



**DANGER**

MasterCraft boats should not be operated at night or in limited visibility even with navigation lights illuminated. The lights have limited visual range. Other boat operators may not see or understand the movements of your boat. When necessary to operate at night **REDUCE SPEED**, use visual and sound signals to slowly return to shore. Night operations may result in collisions or striking fixed objects that could result in death or serious injury.

## Models

All

## Purpose

Although MasterCraft boats are designed to be operated during daylight, there are instances in which operators may find themselves on the water at dawn, dusk or even at night. Weather conditions during daylight may also result in the need to run or anchor with the lights on.

**Note:** The ProStar Navigation Light should only be used in inland waterways and is not classified as an offshore navigation light.

## Location

Vary by model. See the Guide to Individual Models in this Owner's Manual to determine the location of these lights for your model. Lights may be on the bow, gunnels (port light will be red and starboard light will be green), and/or the stern.

## Operation

A three-position switch serves to activate exterior lighting. Turning the switch to the right position will activate bow and/or gunnel lights, and the anchor/mast light. The middle position is OFF, and the left position is for anchor-only lighting.

**SPECIAL NOTE:** The navigation lights are not designed for operation in full darkness with the boat underway at higher speeds. To protect persons on-board and to prevent damage to the boat, do not operate the boat under these conditions.



MasterCraft boats should not be operated after dark, even with navigation lights on. The lights have limited range and luminosity. The boat may not be seen by other boat operations. In emergency situations or if an outing has not concluded prior to dark, use visual and sound signals to slowly return to shore. Attempting to operate at higher speeds may result in damage to the boat as the operator may not be able to see obstructions in the water or other craft. This is not covered under warranty. Also, serious injury or death to individuals may result.

**ADDITIONAL SPECIAL NOTE: In the ProStar model, if the boat is not equipped with tower lighting, the navigational lighting is valid for INLAND RULES ONLY.**

## Troubleshooting

If lights do not operate, check the main circuit breaker panel to determine if a circuit may have tripped. Reset the circuit; if it continues to trip, take the boat to an authorized MasterCraft dealer.

If the circuit breaker has not tripped, the bulb may have burned out. Although the lights are LEDs, which rarely burn out, it is possible. Take the boat to an authorized MasterCraft dealer to have the bulb replaced.

# DOCKING LIGHTS

## Models

Optional on all X Series, XT Series, and X Star models.



## Purpose

Optional docking lights provide a significant aid to navigation in dark conditions. Docking lights are especially useful when pulling up to a dock or into a boat slip after dark.

## Location

Two sets of bright LED lights mounted to the bow rub rail.

## Operation

A digital switch on the lighting page of the Dual Screen Dash turns the lights on and off. Tap the switch to toggle the lights ON and OFF.

## Troubleshooting

If the lights do not operate, check the main circuit breaker panel to determine if a circuit may have tripped. Although the docking lights are LED lights which rarely burn out, it is possible. Take the boat to an authorized MasterCraft dealer to have the bulb(s) replaced when necessary.

# TRANSOM REAR FACING LIGHTS

## Models

Optional on all X Series, XT Series, and X Star models.

## Purpose

Optional transom rear facing lights provide additional lighting to the aft portion of the boat. They may be especially useful when combined with the forward facing docking lights while pulling up to a dock or into a boat slip after dark.

## Location

Two sets of bright LED lights mounted to the transom rub rail.

## Operation

A digital switch on the lighting page of the dash mounted touchscreen turns the lights on and off. Tap the switch to toggle the lights ON and OFF.

## Troubleshooting

If the lights do not operate, check the main circuit breaker panel to determine if a circuit may have tripped. Although the docking lights use LED bulbs which last for an extended period of time, even LED bulbs will eventually burn out and need to be replaced.

# TOWER DOME LIGHT

## Models

Standard on Z10 towers, optional on Z8 towers.

## Purpose

The tower dome light illuminates the cockpit of the boat for use in low light situations or at night.

## Location

The tower dome light is mounted to the underside of the header box on the tower (directly below the tow point).

## Operation

To turn the tower dome light on, press up on the light until it makes a soft click, then release the light. It will turn on. To turn off the light press up on the light and release (there will be no click).

## Troubleshooting

If the light does not operate, check the main circuit breaker panel to determine if a circuit may have tripped. Although the tower dome light is made up of LED lights, which rarely burn out, it is possible that they have burned out. Take the boat to an authorized Master-Craft dealer to have the bulb(s) replaced when necessary.



# COURTESY/STORAGE COMPARTMENT LIGHTS

## Models

All

## Purpose

The courtesy lights and storage compartment lights provide illumination for the interior deck and compartments.

## Location

Mounted to various locations around the deck and in storage compartments.

## Operation

The digital switch that operates the courtesy and storage light can be found on the touchscreen dash on the lighting tab. It can be toggled ON and OFF by tapping the Courtesy/Storage Light button.

## Troubleshooting

If lights do not operate, check the main circuit breaker panel to determine if a circuit may have tripped. Reset the circuit; if it continues to trip, take the boat to an authorized MasterCraft dealer. If the circuit

breaker has not tripped, the bulb may have burned out. Although the lights are LEDs, which rarely burn out, it is possible. Take the boat to an authorized MasterCraft dealer to have the bulb replaced.

## UNDERWATER LIGHTS



### Models

All models, as an option.

### Purpose

Underwater lights provide a significant improvement in visual illumination of the water beneath swim platforms and in the area surrounding the boat stern. In shallow water, this can be especially useful in determining safer operations.

### Location

Located on the transom below the waterline under the swim platform.

### Operation

The digital switch that operates the underwater lights can be found on the touchscreen dash on the lighting tab. Toggle the lights ON and OFF by taping the Underwater button. The lights will come ON and the screen will highlight the lights on the screen. Note that the underwater lights should never be operated unless the boat is in the water. Even though these are LED lights, they generate some heat and require the cooling effect of the water to avoid prematurely burning out the bulbs. Underwater lights may have thermal protection circuitry that will turn the light off when reaching high temperatures. Allow lights to cool in water in order to turn back on.

### Troubleshooting

If lights do not operate, check the main circuit breaker panel to determine if a circuit may have tripped. Reset the circuit; if it continues to trip, take the boat to an authorized MasterCraft dealer. If the circuit breaker has not tripped, the bulb may have burned out. Take the boat to an authorized MasterCraft dealer to have the bulb replaced.

# **SPORT ENHANCEMENT**

# ATTITUDE ADJUSTMENT PLATE

## Models

Standard on the X24, X26, and XStar. XT Series and NXT models, as an option.

## Purpose

When used properly, the plate improves the ride, reduces drag, increases speed, and improves the fuel efficiency of the boat.

## Location

The attitude adjustment plate is permanently attached to the boat's stern, below the waterline. The operator may control the plate using either the video display (as explained more fully in the Video Display Gauges section of this Owner's Manual) or by manual switches located on the driver's armrest.

## Operation

The operation of the attitude adjustment plate is basic. The plate is mounted with an actuator on the transom of the boat. When the plate is lowered, the water flow is redirected, creating an upward force at the boat's stern. When the stern rises, the bow will lower.

Since these actuators are electrohydraulic, they provide an immediate response at the touch of the helm mounted switch. (The attitude adjustment plate can also be controlled through the dual screen and 7" touchscreen dash.) Press and hold UP on the switch raise the center tab. Press and hold DOWN on the switch to lower the center tab into the water.

Because our models have different weights, lengths, speed and performance, it will take some practice for the operator to understand how the boat reacts with the attitude adjustment plate installed. The plate will allow your boat to get on plane faster and continue planing at lower speeds. It improves visibility and the overall safety of your boat.

When making adjustments with the attitude adjustment plate, use short momentary taps of the switch. Continued practice will help you become familiar with how the plate performs.

## Special Attention

Because these plates can adversely affect boat handling if not utilized properly, the following information is provided to assist operators in determining the correct usage of the attitude adjustment plate(s).

## Special Conditions

**Head Sea:** Lower the plate by tapping slightly on BOW DOWN on a single system. This will bring the bow down while maintaining speed. This also allows the hull of the boat to absorb the impact of the waves. This adjustment will result in a more efficient and smoother ride. Changes should be made in small increments to ensure maintaining control of the boat.

**Following Sea:** Make sure the plates are fully retracted by pressing BOW UP on both sides of a dual system, and BOW UP on a single system. This will bring the plate(s) up to a fully retracted position, decreasing lift in the stern and allowing the bow to rise. If the plate(s) is/are deployed, the bow may dig.

**Shallow Water/Hole Shot:** Lower the plate completely by pressing BOW DOWN. This provides lift in the stern of the boat and will keep the bow down. As you throttle up and speed increases, raise the tab by pressing UP.

**Porpoising:** To stop porpoising, press BOW DOWN on the attitude adjustment plate control. The plate(s) needs only to be deployed slightly to correct this adverse situation.



**Improper use of the Attitude Adjustment Plate may result in loss of control, which could result in serious injury or death.**

- While at higher speeds, do not over-trim, as this will cause the bow to lower quickly, resulting in a reduction of speed and may cause the boat to veer.
- When in following seas or when running an inlet, the plates should be fully retracted. This will allow for optimal performance.
- Electrohydraulic actuators provide an instant response. When making adjustments, use short momentary taps of the switch.

## Special Attention

On the XT20, XT21, X22, X24, and X26 models, the attitude adjustment plate is limited to eighty-five percent (85%) maximum extension when the boat speed exceeds twenty five miles per hour (25 mph) or forty kilometers per hour (40 km/h).

Maneuvering a boat with the attitude adjustment plate extended requires practice to master. Initial times running with the attitude adjustment plate extended should be done at low speed with plenty of room. This is critical to learning how the attitude adjustment plate affects control and maneuverability, especially when teaming the attitude adjustment plate with surf tabs.



## Additional Special Attention

DO NOT use the attitude adjustment plate(s) to board the boat. The edges are sharp and can easily slice through skin. The plate(s) is also not sturdy enough to withstand many people's body weight. Damage to the plate(s) in this manner is not covered under warranty. Use only boarding ladders and swim platforms to board from the transom side when boats are equipped with an attitude adjustment plate(s).



### CAUTION

**Never use the attitude adjustment plate(s) to board or assist in boarding the boat. Sharp edges can cut individuals, causing potentially serious bleeding. Damage to the plate(s) from people using it to board the boat is not covered under warranty.**

## Additional Special Attention

Care should also be taken when backing up the boat in shallow water, removing boats from the water on steeply pitched access areas, or backing up with the boat on a trailer. The attitude adjustment plate(s) does not fold or retract, and it may require additional clearance to avoid damage to the plate(s). Resulting damage from failure to follow instructions is not covered under warranty.

## CAUTION

**Care must be taken to ensure that there is always sufficient clearance around the attitude adjustment plate, whether it is in the water or out, particularly on a trailer. The attitude adjustment plate(s) extends beyond the boat transom and is not foldable or retractable. Damage to the plate(s) from failure to allow sufficient clearance is not covered under warranty.**

## Troubleshooting

- If the switch(es) is/are unresponsive, check the main circuit break panel to determine if the circuit has tripped. Reset the circuit and try the switch again.
- If the circuit continues to trip, bring the boat to an authorized MasterCraft dealer for repair.

If the boat does not respond as noted in the above instructions, turn OFF the switch and do not use the attitude adjustment function until the system has been checked by authorized MasterCraft dealer. Malfunction can result in loss of control of the boat.

# AUTOLAUNCH

## Models

All NXT, X, XT, and X-Star Models.

## Purpose

AutoLaunch uses MasterCraft's triple tab logic to automatically deploy the surf tabs (where equipped) and the attitude adjustment plate to help push the boat onto plane more quickly and more efficiently, while reducing bow rise. AutoLaunch speeds are optimized by MasterCraft engineers at the factory and come preset for optimal performance in normally weighted operating conditions.

## Location

AutoLaunch uses built in software to automatically control the position of the Attitude Adjustment Plate and surf tabs (where equipped). The AutoLaunch ON/OFF button appears on the CRUISE and BALLAST AND TRIM hot-key menus. Tap or select the button to turn AutoLaunch ON (the button on the screen will turn green), tap or select the button again to turn AutoLaunch OFF (the button on the screen will turn gray).

## Operation

AutoLaunch crossover speeds are preset at the MasterCraft factory for optimal performance and time to plane. When turned on, AutoLaunch will automatically deploy the Attitude Adjustment Plate and surf tabs (where equipped) to reach plane much faster. Once on plane, the tabs will automatically retract to their raised position.

When wakeboarding it is okay to leave AutoLaunch on, however for optimal surf performance MasterCraft recommends turning AutoLaunch off.

If the boat will be consistently run very light (no ballast and low people weight) or very heavy (full ballast and high people weight) loading conditions, AutoLaunch's Crossover Speed settings can be adjusted on the Settings tab under Ballast/Tab Settings. The crossover speed is the speed at which the tabs retract to their upright position once the boat is on plane. Increase the Crossover Speed if the boat is being run consistently with heavy loading conditions. Decrease the Crossover Speed if the boat is being run consistently with very light loading conditions. It is possible to adjust the surf tabs and attitude adjustment plate independently to optimize time to plane.

# SURF STAR SYSTEM



## Models

The Surf Star System is an optional feature for NXT, XT, X, and X Star models. On X and XT models, the Surf Star System includes an enhanced screen interface. See the chapters of this manual dealing with X and XT screen operations for more information.

## Purpose

The Surf Star System gives the operator precise control over the dimensions of the boat's surf wave. Using the dashboard screen or the helm-mounted switchpack, the operator may set and modify the amplitude of the surf wave created by the boat's wake shaping devices. This allows the operator to program a surf wave matching the style, skill-level, and/or preferences of the rider.

The Surf Star System uses stainless steel surf tabs to create powerful waves. This is made possible by the electrical feedback

configuration of the Surf Star System. In response to user commands, the dash screen signals the PDMs (Power Distribution Modules), electronic devices which distribute electrical power to connected systems. With the power supplied by the PDMs, the transom-mounted electrohydraulic actuators drive the surf tabs into deployment. The resulting displacement influences and modifies the amplitude of the boat's surf wave.

Using the Surf Star System, the operator may deploy tabs at different angles to create waves of varying type. This gives the operator a wide range of control over wave amplitude. Mellow waves are created by deploying the tab further into the water on one side of the boat, and steeper waves by retracting the tab.

## Location

The surf tabs and actuators—also known as wake shaping devices—are installed on the port and starboard sides of the transom, beneath the swim platform. An additional center tab is also present. Tabs may be controlled using the helm-mounted switchpack or the dash screen video display.

In addition to transom-mounted tabs and actuators, the Surf Star System also features two extra ballast bags. These bags reside in the port/starboard aft sundeck compartments. New users are encouraged to receive instructions from an authorized MasterCraft dealer when uninstalling, reinstalling, or winterizing ballast bags and related devices, though walkthroughs may be found within the “Care and Maintenance” section of this manual.

**Electrohydraulic  
actuator**



**Additional sundeck  
compartment ballast bag**



The Surf Star System is powered by PDMs (Power Distribution Modules). On NXT, XT, and ProStar models, PDMs are found underneath the dash. On X models, they are found underneath the driver's seat and in the observer storage compartment.

## Operation

On all models, users may control tabs and ballast from the helm-mounted switchpack. To adjust tabs, use the UP and DOWN buttons. To adjust ballast, use the FILL and EMPTY buttons. For additional instructions relating to ballast operation, refer to the “Ballast Systems” section of this chapter. For additional instructions relating to tab controls, refer to the chapter of this owner's manual that deals with operating your specific model.

As an alternative to the helm-mounted switchpack, the user may also operate the Surf Star System from the dashboard touchscreen interface. Operation of the screen interface can vary substantially depending on the model in question. For more information on screen controls, see the screen operations chapter for your model.

## **WARNING**

**Electrohydraulic actuators provide an instant response. When making adjustments, use short momentary taps of the switch. Large adjustments to surf tabs may result in loss of control, which could, in turn, cause serious injury or death.**

## Troubleshooting

If one of the Surf Star System's components does not seem to be responding to the switch, check the appropriate circuit on the main breaker board or the PDM screen diagnostics menu. If the circuit continues to trip after you have reset the breaker, take the boat to an authorized MasterCraft dealer for inspection. Recurrent tripping of a circuit may be a sign of a deeper electrical issue.

For additional information on circuit breakers and diagnostics, refer to the “Basic Electrical Components” chapter. For additional information on digital screen diagnostics, refer to the chapter on operating your particular model. Serious, recurring electrical issues should be addressed by an authorized dealer.

## Additional Information

Because MasterCraft aims to bring you the best wakesurfing experience possible, it may occasionally be necessary to download software updates for the Surf Star System's screen UI. On X and XT models, you can update the screen software by accessing the Spark Network Connections page in the System Settings menu, joining a wi-fi network, and scanning for connections. Alternatively, an authorized dealer can install updates via USB drive.

In some instances, the Surf Star System may require tab position sensor recalibration. To recalibrate the position sensor on X and XT boat models, access the Tab Diagnostics page in the System Settings page of the dash touchscreen display and use the controls provided. For more information on sensor recalibration, discuss the topic with your authorized MasterCraft dealer.



# BALLAST SYSTEMS

## Models

Ballast systems are found on all models. The NXT, X, XT, and X Star models utilize triple or quad hard tank ballast systems. If the boat includes the optional Surf Star System, two additional plug-in ballast bags are added to the aft sundeck compartments.

On NXT models, additional integrated ballast bags may be installed optionally. These are installed beneath the port and starboard cockpit seats. They enhance the NXT's wave potential.

The ProStar uses a single MTS hard tank designed for competition training. For the most part, the MTS tank functions similarly to the multi-tank systems found on the NXT, X, XT, and X Star. However, the MTS tank is not compatible with Surf Star plug-in ballast.

## Purpose

Ballast systems are specially designed for each model to enhance the boating experience. By creating deeper, more dynamic waves, beginners and professionals alike can have experiences that are more enjoyable—even record-setting. For simple outings and improved, faster handling, ballast systems may be left empty.

## Location

Ballast tanks are located under the deck, in the hull, hidden from sight. Optional plug-in bags are located in the aft sundeck storage areas, on either side of the engine compartment. The ballast outflow vents are located on the upper perimeter of the hull. Depending on the model, the overflow may be on the bow or the gunwale. Fill, empty, and overflow locations should never be obstructed.

On all X, XT, and Star models, ballast fill/empty locations are located underwater and should be kept clear of debris. (See the “Care and Maintenance” section of this Owner’s Manual for more details.) NXT Series models pump ballast water in from the hull bottom, but pump water out of thru-hull vents located on the hull’s sides. Ballast overflow vents are located on the side of the hull.

Ballast switches are found on the screen and the manual helm switchpack. The location of the manual switchpack varies on some models. On the NXT, it is located on the dash mount. On X, XT, X Star, and Pro Star models, it is located to the left of the dash touchscreen. In addition to the manual switchpack, ballast fill levels can also be controlled via any X, XT, or Star video display (see the “X and XT Screen Operations” section of this Owner’s Manual).

## Operation: X and XT Series

To fill a ballast tank, press the FILL button. The button will light up and the boat will begin to fill the desired ballast tank. To stop filling, press the FILL button again. The pumps will pause and the light will

go off. To resume filling the tank press the FILL button again. When the tanks are full, operators will see water being vented out of the ballast overflow vents on the hull side. When a ballast tank is at 100 percent full, pressing the FILL button again will begin a 30 second override. The pumps will overfill the tanks, excess water is pumped out of the ballast overflow vents on the hull side.

To empty a tank press the EMPTY button. The button will light up and the ballast pumps will begin to empty the desired ballast tank. To stop emptying, press the EMPTY button again. The light will go off and the ballast pumps will stop running. To resume emptying the tank, press the EMPTY button again. When a ballast tank is at zero (0) percent full, pressing the EMPTY button again will begin a 30 second override. The pumps will over-drain the tanks, excess water is pumped out of the hull bottom.

The ballast system in X Series, X Star, and ProStar models operates on an automated system that shuts down automatically when the emptying process has been completed.

## Operation: NXT Series

The three-position switches are clearly marked: FILL, OFF (in center), and EMPTY. Toggle the switch in the direction desired. Be certain to return the switch to OFF when functions are complete. When the tank(s) is/are full, operators will see water being evacuated out of the ballast overflow vents on either the gunnel or

hull side (see Guide to Individual Models in this Owner's Manual to determine the location of the ballast overflow).

The ballast system in NXT models operates on an automated system that shuts down automatically when the emptying process has been completed.

### CAUTION

**Failure to return the manual operation switch on an NXT ballast system to OFF after emptying the tanks can cause the ballast pumps to fail. Such failure is not covered under warranty.**

### WARNING

On models equipped with optional plug-in bags, if the bags are emptied and disconnected from the system, the original bridge connector **MUST** be reinstalled. Failure to do so will allow any water pumped into the rest of the ballast system to evacuate through the quick connect, which can result in flooded storage compartments which could sink the boat.

**The original bridge connector in the ballast system must be reinstalled if the optional plug-in bags are removed from the system. Failure to do so will result in any water in the ballast system evacuating into the storage compartment, potentially flooding the storage compartments. This could sink the boat, resulting in serious injury or death.**

In systems that operate on timers (XStar, ProStar, X Series and XT Series models), note that the timer operation varies by model. Timers may also be impacted by the addition of optional bags. See your authorized MasterCraft dealer for assistance in determining proper timer settings.

## Special Attention

In standard ballast systems, the engine must be operated at 1500 RPM or more during the fill and empty processes for optimal performance. On models equipped with the FastFill Ballast System (see the FASTFILL BALLAST PUMP section of this Owner's Manual) the engine must be operated under 1500 RPM for optimal performance. Operating the FastFill system at higher RPM can cause the low voltage alarm to sound. Check engine specifications for related engine idle speed, which, in some instances, may be too low for the empty/fill operation to be properly accomplished. Failure to increase or decrease engine RPM to the required level may result in malfunction or permanent damage to the ballast pumps that force water through the system or to the engine's electrical system. Such damage is not covered under your warranty.

## Special Attention

NEVER tow a trailer with water in the boat's ballast tank(s)! Even small amounts of water can cause serious problems with the required balance of the boat on the trailer (see the Trailers section of this Owner's Manual if you own a MasterCraft trailer).

Note that this information is also applicable when towing with trailers built and sold by other manufacturers. Correct balance is critical to safe trailering.



**Never tow a boat with water in the ballast tank(s). Doing so may damage the boat and trailer, resulting in loss of control that could cause serious injury or death.**

## Additional Special Attention

Ballast pump impellers MUST be replaced on a regular basis (at least annually, but more often as necessary). Its purpose is to move water from the intake on the hull bottom and into the ballast tank, and vice versa when emptying the ballast tank. Through usage, the impeller, by design, will wear and eventually need replacement (see Care and Maintenance section of this Owner's Manual). Authorized MasterCraft dealers can help to locate any and all pumps and impellers. Failure to follow directions may result in damage to the ballast pump that is not covered under warranty.



## CAUTION

**Failure to follow instructions regarding the care and maintenance of ballast pumps as outlined in this Owner's Manual can result in damage to the ballast pump that is not covered under warranty.**



## Troubleshooting

If the ballast pumps do not turn ON when the switch is activated or the touch screen is used, check that the circuit has not tripped on the main circuit breaker panel, or use PDM diagnostics to reset the fault. Continual tripping after reset is indicative of an issue that requires the attention of an authorized MasterCraft dealer.

If the ballast pumps do not work and the circuit breaker has not been tripped, it is likely that the pump has malfunctioned. This can be the result of running the impellers while the tanks are empty. Regardless of cause, it is necessary to take the boat to an authorized MasterCraft dealer to determine whether the impeller and/or pump must be replaced.

Your authorized MasterCraft dealer has an extensive troubleshooting tree for ballast systems that includes parts of the system that are not accessible to the consumer. Because a malfunctioning ballast system can cause problems with the control of the boat, no potential issue that arises with the system should ever be ignored.

# FOUR ZONE BALLAST

## Models

XStar and X Series Models (excluding X26)

## Purpose

The four zone ballast system features four individual ballast zones to add customization to the wakes and waves produced by your boat. Each zone can be filled to custom fill levels using the helm mounted touchscreen. Profiles in the screen for wakeboarding and surfing also control factory configured ballast tank fill levels.

## Location

Each of the four tanks corresponds to a particular ballast zone. The rear port and starboard tanks flank the engine, aft of the boat's center of gravity. When optioned with the Surf Star System, ballast bags are plumbed into these tanks to add extra weight to the boat. The third ballast tank is located under the walkway to the bow of the boat.

The fourth ballast zone features a "U" shaped tank that runs the width of the boat just forward of the engine. This tank is referred to as the "midship tank." The midship tank should be filled according to the pre-set wakeboard and surf profiles in the boat.

The midship tank is designed to move water from one side of the boat to the other when surfing, immediately offsetting weight. It can be filled to 100 percent when wakeboarding.

## Operation

The ballast pumps are operated through the dash mounted display or through the manual switches. For detailed operating instructions see the "X and XT Series Dual Screen Dash" section of the

## Winterization

Ballast tanks, pumps, hoses and fittings must be properly winterized to prevent freezing damage during winter storage. Because of the complexity of preparing a ballast system for winter storage, as well as the possibility of extreme damage to the ballast system if a preparation error is made, MasterCraft recommends scheduling an appointment with an authorized dealer's service department to have a certified technician to perform all winterization procedures, including ballast winterization.

MasterCraft uses a -50 F RV type, nontoxic, propylene glycol based antifreeze to winterize every boat built at the factory. Any antifreeze meeting these requirements is acceptable for MasterCraft engine, ballast, and freshwater system winterization. Be aware that colder climates may require antifreeze with a -100 F temperature rating.

## Winterization Process

1. Completely empty all ballast tanks and bags of any water that may be in the ballast system.
2. With all bags still hooked up to the system, identify the ballast thru-hull vents (see guide to each model in this Owner's Manual).
3. Add two gallons of -50 F RV type nontoxic propylene glycol based antifreeze to each of the thru-hull vents. Colder climates may require antifreeze with a -100 F temperature rating.
4. Once the antifreeze is in all ballast zones, use the manual ballast

switches in the helm area to drain the antifreeze through the system. This will push antifreeze through the ballast system, across all pumps, hoses, fittings and intake valves.

5. Be cautious while using the ballast switches as antifreeze will be pumped out of the intakes mounted to the bottom of the boat. Once antifreeze begins to pump out of the boat through the 4 ballast intakes (three aft, one forward), turn the pumps off.

# FASTFILL BALLAST PUMPS

## Purpose

FastFill ballast pumps are designed to move water through the ballast system and into or out of ballast tanks nearly three (3) times faster than standard pumps.

## Location

Ballast pumps are mounted throughout the boat.

## Operation

Fast fill pumps operate using either the helm mounted touch display or the manual ballast switches on the dash. For detailed operating instructions, see the "X and XT Dual Screen Dash Operation" section of the MasterCraft Owner's Manual.

## Annual Maintenance

MasterCraft recommends scheduling an appointment with an authorized dealer's service department to have a certified technician perform all impeller changes.



Ballast pump impellers should be changed every 100 hours as part of annual maintenance. To change ballast pump impellers:

1. Remove three (3) of the four (4) cover screws. Loosen the fourth screw. Retain the screws for the re-installation process. Swing the cover out of the way to allow access to the impeller.
2. Using needle-nose pliers, pull the old impeller out of the casing.
3. Lubricate the new impeller before installation using lubricant included in the package with the impeller kit.
4. Install the new impeller. It is intentionally larger than the casing in the pump. Gently squeeze it in, making sure the pump's shaft aligns with the hub on the impeller.
5. Carefully slide the cover plate back into place. No silicone is necessary due to the built-in gasket on the plate. Tightening the screws should prevent leakage.
6. Run water through the ballast pumps. Ensure there are no leaks.

# PYLONS

## Models

All

## Purpose

When properly utilized, ski pylons allow skiers the opportunity to be towed behind the boat with a sensible and unobstructed view by individuals in observer seats.

## Location

Varies by model, but pylons are generally adjacent to or integrated within aft seating. (See Guide to Individual Models in this Owner's Manual for specific model locations.)



## Operation

See the Ski/Wakeboard Rope information under Additional Safety Support in this section of the Owner's Manual. Avoid tangling rope around the pylons or any other portion of the boat.

## Special Attention

Some pylons are removable. In those instances, always be certain that the pylon has snapped securely into place prior to usage. Failure to do so could result in injury or loss of the pylon.



Ensure that removable ski pylons have securely snapped into place prior to use. Pylons that are not secure can become detached during operation. In these circumstances, the pylon could hit persons on board or skiers behind the boat, causing injury.

## SWIM PLATFORM



The swim platform has a maximum rated weight capacity of 1000 lbs. Exceeding this limit may result in serious property damage and personal injury. Your warranty most likely will not cover damages ensuing from a failure to follow our recommendations.

## Models

All models. Materials vary. Most models also offer optional styles.

## Purpose

Swim platforms provide easy access between the interior of the boat and the body of water. Care should always be taken by persons moving between the boat and the water. While the platforms have been designed to be slip-resistant, they may still become slick, and footing can become difficult. All movement should be done with that in mind. Failure to exercise caution can lead to injury. Also, boisterous play is inappropriate on the swim platform because injury can occur.



Never allow boisterous behavior on the swim platform. A fall from the swim platform could result in contact with transom-mounted metal edges, which could cause minor to moderate injury.



**PROPELLERS MAY CAUSE SERIOUS INJURY OR DEATH.** Shut off the engine(s) when near persons in the water prior to using sunpads, swim platforms or boarding ladders.

## Location

Swim platforms are attached to the boat transom.

## Operation

Platforms may be permanently attached to the transom. However, some platforms feature a bracket that allows them to fold down, reducing the amount of room required for storage. To determine whether the boat is so equipped, look beneath the platform and see if there is a bracket with a pin. If so, the swim platform can be folded. To do so properly, follow these instructions:

**NOTE:** Platforms themselves are fairly heavy, and releasing the bracket may result in the platform falling down, and thereby striking the transom with excessive force. Please provide some kind of manual support to the platform at the time of releasing the bracket, and then slowly lower the platform into place for towing or storage.



**NOTE:** The surf tabs may also need to be lowered prior to lowering the swim platform.

## Folding Down the Platform

Remove the safety hinge pins in each swim platform bracket.

Begin by lifting the platform about four (4) inches upward while easing the platform away from the boat transom. This will allow the platform to move freely on the hinge.

**NOTE:** Ensure there is no tightness while the swim platform is being folded. There should be no binding during this action.

## CAUTION

The platform must be raised and locked into position for transportation of the boat, as well as use of the platform while boating. Leaving the platform down may result in damage to the boat transom during transport that will not be covered by the warranty.

## Securing the Platform

Lift the platform to an angle of approximately 20 degrees from the boat. Lightly push the platform (do not shove nor jam) toward the transom to allow the platform to set in place.

Verify that the platform is in the locked position and will not fall down. Failure to verify that the platform is locked may result in the platform falling while someone is on it and could result in injury. Insert one (1) safety hinge pin into each platform bracket.

 **WARNING**

The platform must be raised and locked into position. No one should be allowed on the platform until the platform is securely locked in place and the engine is OFF. Failure to do so may result in serious injury or death!

## Special Attention

MasterCraft reminds consumers to review the Common Sense Approach section of this Owner's Manual, and pay particular attention to avoiding "teak surfing" or "platform dragging," which expose the participant to excess carbon monoxide.

 **DANGER**

**Carbon monoxide is a colorless, tasteless, odorless and poisonous gas that accumulates rapidly and can cause serious injury or death. Exposure to carbon monoxide can be fatal in a matter of minutes. Exposure to even low concentrations of carbon monoxide must not be ignored because the effects of exposure to carbon monoxide can build up and be just as lethal as high concentrations. Carbon monoxide from exhaust pipes of inboard or outboard engines may build up inside and outside the boat in areas near exhaust vents, particularly during slow-speed operations. STAY AWAY from these exhaust vent areas, which are located at the**

stern of the boat, and DO NOT swim or engage in any watersports or other activities in or near the stern area of the boat, including, without limitation, the swim platform and the rear sun deck, when the engine is in operation. Under no circumstances should the owner and/or operator allow persons to hold onto the swim platform while the engine is operating and the boat is in motion. These activities (sometimes known as "teak surfing" or "platform dragging," where the participant holds onto the swim platform and is pulled through the water, and/or "body surfs" immediately behind the boat) are extremely dangerous, highly likely to result in death or serious bodily injury, and are a misuse of this product.

## Additional Special Attention

Swim platforms, especially those that feature teak wood, require consistent maintenance to retain luster and finish (see the Care and Maintenance section of this Owner's Manual for important care requirements). Failure to follow instructions can result in damage to the platform that is not covered under warranty.

If at any time the swim platform does not feel secure (there should be no noticeable movement or "play" in relation to the rest of the boat), immediately leave the swim platform. Verify that, whether permanently attached or held in place with brackets, the platform is fastened as designed. If it is not, stop using the swim platform and take the boat to an authorized MasterCraft dealer for repair.

# PLATFORM CARE

## All Wood Platforms

If shoes are worn when walking on teak wood platforms, they should be proper boating shoes. Black-soled shoes are likely to scuff the surface, resulting in marks that may be difficult or impossible to remove. These marks or stains are not covered under warranty. To maintain its original appearance and finish, teak wood will need regular cleaning and oiling. Unprotected wood will turn gray and could split or separate. If this happens, it may void the warranty. New wood platforms have been sealed and finished with an oil-based, wood preservative by the manufacturer. Platforms will keep a new look and last for many years if properly maintained. For best results oil the platform and allow it to dry before the first use. If the boat spends a lot of long weekends on the lake with the swim platform in the water, or if the platform sits uncovered in the sun, it will need to be oiled more often. The platform should be covered when not in use or when stored for the winter.

## Oiling the Teak Platform

The teak platform will require additional frequent maintenance if it is regularly exposed to direct sun or water. In most cases, the platform will require maintenance when it gets a dry frosted look, or when it quits easily shedding water. A platform that gets a lot of sun and water may need oil 1-2 times a month for the first year. If

the platform starts to get a tacky or gummy feel, oiling may be too frequent and the platform should be oiled less often.

### To oil the platform:

Before oiling the platform, you will need teak, tung or linseed oil.

1. Before applying teak, tung or linseed oil to seal and protect the platform, the wood should be cleaned and with a mild soap and water mixture. Harsher cleaners can damage and strip the wood's finish.
2. Use a stiff bristled brush or rag to clean away dirt and stains. After cleaning, pat the platform as dry as possible with a clean towel, then let the platform air dry.
3. Use a cloth or brush to saturate the platform with teak, tung or linseed oil (front, back and edges). Push the oil into all cracks, crevices and end grain.
4. Let the platform dry in the shade for 30-45 minutes. After the platform has had time to soak in fresh oil, use a soft cloth to gently buff off all excess oil that does not soak into the platform.

# SKI RACKS

## Models

ProStar, as an option.

## Purpose

The ski racks provide a sleek and attractive method to store skis in the gunwales on both sides of the boat interior. These ski racks are constructed with anodized aluminum and particular attention must be paid to prevent corrosion. See Corrosion in the Care and Maintenance section of this Owner's Manual.



## Location

The ski racks are mounted to the inward side of the deck.

## Operation

The ski racks operate easily by tapping the lower bar of the assembly. Holding down on the bar keeps the ski rack holder open for easy access or storage of the skis. Releasing the lower bar closes the rack and holds the skis in place. Prior to operating the boat, always check that the skis are secure in the rack. Failure to do so could result in a ski or skis becoming dislodged during boat operation. This could result in the skis striking individuals seated in the aft portion of the boat or the skis going overboard.



**Always verify that skis stowed in the ski racks are secure prior to operation of the boat. Otherwise, skis may become dislodged and strike passengers in the aft section of the boat or the skis going overboard.**

# TOWERS

## Models

The Z Tower is featured on all NXT, XT, X, and X Star models. It is available in three varieties: Z6, Z8, and Z10. NXT models may only be equipped with the Z6. X, XT, and X Star models may be equipped with the Z6, Z8, or Z10. The ProStar has its own unique tower.



## Purpose

Towers provide multiple benefits to the boat owner. Their high tow points make them a great resource for watersport enthusiasts, while their supplemental lighting, storage space, and stereo output contribute ambience and comfort. For these reasons, many boat owners consider towers to be an invaluable feature.

## Location

Towers are located amidships. For the locations of specific tower components, see the section of this chapter focusing on the model in question. For the locations of accessories and add-ons, see the “Tower Accessory Options” section of this chapter.

### CAUTION

**Because Z towers are specifically designed and tested for our boats, MasterCraft discourages installation of after-market towers. After-market towers may lead to damages and will most likely void the warranty. We urge owners to buy towers and related accessories from an authorized MasterCraft dealer.**

## Operation

Each MasterCraft tower has a unique operation method. The Z6 is operated using a pull-pin mechanism, while the Z8 and Z10 utilize

hydraulic support. For detailed instructions on how to use a specific model, refer to its respective section in this manual.

## Raising and Lowering the ProStar Tower

### Lowering (and Leaving the Tower Attached):

- While applying some upward/forward pressure on the tower header, loosen one of the hand knobs.
- Repeat for the other side (or a second person can do this simultaneously). **Note:** Typically, it is easier to loosen both sides first compared to completely removing one knob and then loosening and removing the second. The angled thread on the knobs can put the tower/threads in a bind.
- Completely unscrew the hand knobs until they are disengaged (a spring pushes them out).
- Fold tower back and rest it on the motor box (or the tower stands included with the boat to protect upholstery). Some padding is advised to protect adjacent surfaces.

### If Removing, Follow These Additional Steps:

- Pull excess wires out from under the deck.
- Disconnect the light wires. **Note:** On the tower side, fold the wires and push them up into the tube. On the deck side, fold/loop the wires up and stuff them back into the access hole.

## CAUTION

**Do not plug the wires together. This will act as a direct short if the light switch is turned on, resulting in a tripped circuit breaker.**

- Looping the wires up so they create pressure against the deck/hole will provide additional resistance to help prevent them from falling down.
- **Do no** If this happens, the side access panel will have to be removed to re-route them through the access hole.
- Ensuring the wires are clear, stand the tower all the way back up to its normal operating position.
- From the back side of the tower, push the base of the tower leg forward.
- It should easily slide about 1/2" before catching on a small, raised feature intended to keep the tower from sliding out too easily and the operator losing control of it.
- A small push or bump with the palm of your hand should be enough to fully disengage the locking clip
- Be careful not to push/strike the tower hard enough that it falls on you. Very light pressure with your other hand on the upright should prevent this from happening. Too much pressure will possibly prevent the clip/foot from sliding and disengaging.
- Repeat on the other side.
- Remove tower from the boat.

**If desired, the locking hook can be stowed in the tower mounting base.**

- Push the hook forward in its groove, until it will fold sideways towards its stowed position.
- Collapse the locking clip in order to completely stow.

**Installation is essentially the reversal of the removal, assuming the hook is stowed:**

- Collapse locking clip and rotate out of the stowed position.
- Spring load will push the hook to the back of its groove. **Note: Take care that you don't pinch your fingers!**
- Place tower in front of the hooks in the upright position.
- Pull each tower foot back into the hook.
- Rotate tower back to hook up navigation light.
- Connect the light wires.
- Feed all of the excess wires and connectors below the deck through the access hole.
- The remaining wire should be straight.
- Slowly stand the tower back up, keeping an eye on the wires and ensuring they don't get pinched.
- Make sure that both tower feet/hooks are all the way to the back of the groove. If they are not, the hand knob threads won't be aligned.
- Get one hand knob started and threaded most of the way in. **Note: If the threads don't start easily, it could be that the tower is in a slight bind. Back off the hand knob or lightly bump the tower/**

foot to free the bind before continuing to tighten.

- If you have two (2) people, starting and tightening together is easiest.
- Start the second hand knob and tighten until it is snug.
- On the other (original side), put a moderate amount of forward pressure on the tower header while torquing the hand knob tight.
- Repeat the previous step on the second side. **Note: These last two steps are important to ensure that the tower does not come loose during operation.**

## The Z6 Tower



Whereas the Z8 and Z10 towers both rely on hydraulic systems to facilitate the process of raising and lowering, the Z6 is the only model in the series which uses a pull-pin mechanism and which requires full manual operation when raising or lowering.

The Z6 locks into place using a quick release pull-pin. After loosening the pull-pin, the user applies upward force to bring the tower into standing position. Once the tower is upright, the user reinserts the pull-pin to firmly secure the tower.

### To raise the Z6 tower:

- Loosen both pull-pins in order to unlock the tower.
- With the pull-pins loosened, apply upward pressure to the tower header until the tower stands upright.
- Insert the pins once the tower reaches standing position.

### To lower the Z6 tower:

- Remove all boards from the board racks. Fold the racks to the inward position.
- Remove the pull-pins from either side of the tower. To prevent binding, you may find it necessary to place some upward force on the center of the tower.
- With the pins loose, put gentle downward pressure on the top of the tower until it reaches the down position. **Note:** The tower will fall if not appropriately handled while lowering. Be prepared to support the tower's weight for the entirety of the set-up procedure, from standing to resting position.
- Reinsert the pins to secure the tower.

## **WARNING**

Always reinstall the locking mechanism on both sides of the Z6 immediately after raising or lowering the tower. Failure to do so could result in the collapse of the tower, causing serious injury or death. The tower could also be damaged if left upright or down without the pins fully locked and secured.

## **CAUTION**

When setting up the Z6 tower, it is sometimes advisable to receive assistance from another individual. Depending on the weight of the tower, assistance may reduce the chances of damaging the tower or the boat itself. In general, you should exercise caution when lifting any MasterCraft tower.

## **WARNING**

The tower will fall if not appropriately handled while lowering. Be prepared to support the tower's weight for the entirety of the set-up procedure, from standing to resting position. Damage inflicted by mishandling of the tower may not be covered under warranty. Follow the instructions as stated in this manual.

## The Z8 Tower



Unlike the Z6, the Z8 is augmented with hydraulic fluid support. The unique assembly of the tower leg decreases the amount of effort needed to raise or lower the tower. When the operator pushes the release on the header box, a gas-assisted hydraulic fluid system frees the tower, allowing it to rotate. The operator may then raise or lower the tower while keeping their finger on the release.

**Note:** MasterCraft discourages the addition of after-market speakers to the Z8. After-market speakers may increase the amount of force needed to lift the tower, impacting the amount of gas assist needed for the Z8 to easily raise/lower. If you choose to install after-market speakers, consult an authorized dealer beforehand. It may be necessary for MasterCraft to alter the gas assist and keep the raising/lowering effort within reason. A trained professional should perform this service for you.

### To raise the Z8 tower:

- Identify the release button on the tower header box. Pressing this button will activate the hydraulic fluid system in the tower leg, freeing the tower and allowing it to rotate.



- Press and hold the release button.
- While pressing down on the release button, exert upward force on the tower to bring it into standing position. **Note:** The tower will lock in place if you lift your finger from the button.
- Once the tower is fully upright, let go of the button. The tower will lock in place, no additional steps needed.

### To lower the Z8 tower:

- Ensure the board racks have been swiveled safely inboard.
- Identify the release button on the tower header.
- Press and hold the release button.
- With one hand supporting the header and the other pressing the button, begin to pull aft and downward on the tower. It will begin to decline into the resting position.
- Fold the tower while keeping your finger on the release button. When you are done, lift your finger from the switch.

## The Z10 Tower



The Z10 features a hydraulic pump that allows the operator to raise or lower the tower at the press of a button. It is controlled using a pair of rocker switches found on the ignition pad. To raise the tower, press and hold the TOWER UP switch, letting the internal hydraulic pump raise the tower into the deployed position. To lower the tower, press TOWER DOWN and let the tower decline. Always ensure the racks have been swiveled fully inboard prior to operation.

### **WARNING**

**If the Z8/Z10 have not been positioned fully upright, you should *not* tow individuals. Doing so may result in injury or death.**

### **CAUTION**

**When operating Z6, Z8, and Z10 towers, individuals should keep all body parts, especially fingers, away from hinge areas.**

 **DANGER**

Always ensure that there are no people, power lines, or objects in the way when raising or lowering the tower. Individuals and their limbs may be subject to injury if caught in the tower's path.

 **WARNING**

Please note with special consideration that MasterCraft has carefully determined the maximum amount of weight and total accessories that the tower can safely hold. Ignoring this information could result in injury to the operator and/or passengers.

85 pounds is the maximum aggregate weight allowed for accessories mounted on the tower. Exceeding this restriction can result in tower failure, which could cause serious injury or death to the operator and/or passengers.

 **WARNING**

Occupants of the boat should never stand on, sit on, or jump from the tower. MasterCraft towers should only be used for approved sport towing. See the “Safety” chapter of this Owner’s Manual for a list of approved activities.

 **WARNING**

Immediately stop using the tower if it appears to be unsteady, insecure, or shows signs of gel coat cracking or other stress near the tower legs. Continuing to use the tower under these conditions could result in serious injury or even death. An authorized MasterCraft dealer must determine if the damage can be repaired. If the damage is the result of misuse of the product, such damage will not be covered under the warranty policy.

## Troubleshooting

In rare cases, the Z6 pull-pin locking mechanism may have trouble engaging. This is a result of misalignment and may lead to scarring. If the locking mechanism on your Z6 does not engage properly, take it to an authorized MasterCraft dealer for inspection.

If the Z8/Z10 tower does not respond to the switch, verify that the circuit has not tripped at the cylinder/pump. If it has not tripped at the cylinder/pump, examine the breaker board. (See the chapter “Basic Electrical Components” for information on breakers.) If the tower is still unresponsive after toggling the breaker, you should take the boat to an authorized MasterCraft dealer.

Although Z towers are sturdy, well-designed equipment, you should know what to do in the unlikely event that a tower causes damage or exhibits signs of insecurity. If there is evidence of tower-induced damage to the deck (such as gel coat cracking) or insecurity (such

as unsteadiness), stop using the tower and take it to an authorized MasterCraft dealer for closer inspection. The dealer will be able to diagnose repairs. If the damages appear to have been inflicted by the owner's actions, warranty may not cover the repairs.

If you have any questions regarding the hydraulics used in the Z8 and Z10 towers, contact an authorized MasterCraft dealer. The dealer can provide information from the OEM manufacturer regarding installation instructions, system diagrams, part numbers for hoses or fittings, thread sealant, hydraulic fluid, pump filling processes, test procedures, operating pressure, alternate means of operation, maintenance, and/or troubleshooting.

## TOWER ACCESSORY OPTIONS



### Models

Aside from the ProStar tower, all tower models feature lights, speakers, and board racks as optional accessories.

Board racks are available in two varieties: essential and supreme. Essential board racks accommodate up to 4 wakeboards (or 4 thinner surfboards) at a time. Supreme board racks accommodate up to 4 wakeboards and/or surfboards at a time.

Essential board racks are the standard/default rack for every model. Supreme board racks are available as an optional upgrade for all models except the NXT. On X, XT, and X Star models, the consumer may also upgrade to a double board rack set-up.

Four speaker options are available to the consumer: the S70, S80, S85, and T85. The S70 is the default speaker for all NXT towers. The S80 is the default speaker for X and XT towers. The S85 and T85 are optional upgrades for Z8 and Z10 towers (X/XT).

Various lighting accessories are also available to the consumer. Dome lights are small, circular lamps in the header box. Speaker can lights are larger devices that mount to the header tube. They exist in two forms—downward facing and forward facing—and are only available for the S85 and T85 configurations.

### Purpose

Tower accessories increase general comfort and convenience. Lights improve visibility during low-light situations, illuminating the aft deck, swim platform, and nearby waters. Speakers enhance the quality of music and other audio entertainment. Board racks keep the deck clear of surfboards and wakeboards, increasing the amount of available space in the cabin.

## Location

All options are mounted to the tower. Board racks are found on the tower arm. The dome light is attached to the header box. Can lights and speakers are mounted to the header tube. Speaker can lights run along the bottoms of the tower cans.

## Operation

**Lights:** To activate forward-facing lights and speaker lights, use the lighting tab on the touchscreen. To adjust speaker lights, use the + and - buttons on the same screen. To activate the dome light, push up on the light until it activates. (For more information on lighting accessories, see the “Visual Assistance” chapter.)

**Speakers:** Tower speakers are controlled using the audio settings found on the dash touchscreen. For more information, consult the “Screen Operations” chapter of this manual.

**Board racks:** Board racks are operated using a black and red lever system on the backside of the rack. To open the clamps, press down on the red release button. The clamps will open in response. To shut the clamps, push the lever/handle upwards. Once the lever/handle has moved as far into its slot as it can go, you will hear the red lock button click into place. Remove your finger from the button.

Regardless of which board type you choose to store inside the rack, it is very important to make sure the board is securely clamped. This will prevent the board from coming loose when the boat is in operation. Additionally, make sure that you are storing the correct type of board inside the clamps. An improper fit will leave the board

too loose in the racks. Resulting loss, damage, or injury is not the responsibility of the product manufacturer.

## Troubleshooting

**Lights:** If one of the lighting accessories does not work when the digital switch is flipped to the “On” position, check the “Diagnostics” menu on the dash touchscreen. Reset the circuit if necessary. If the circuit continues to trip, or if the circuit is on but the lights still don’t work, take the boat to an authorized MasterCraft dealer.

**Speakers:** If the speaker accessories do not work when the digital switch is set to the “On” position, check the “Diagnostics” menu on the dash touchscreen to find out whether the circuit has tripped. Reset the circuit if necessary. If it still does not work, take the boat to an authorized MasterCraft dealer for inspection.

**Board Racks:** If a board rack seems unsecured and you determine that the proper board is in use, do not leave the board in the rack. Take the boat to an authorized MasterCraft dealer.

## CAUTION

**If you choose to install secondary board racks, ask your dealer about installing a tower stop-pin in the main knuckle behind the access plates. A stop-pin can limit the tower’s downward travel, preventing the secondary racks from colliding with the deck and upholstery. Failure to install a protective stop-pin for secondary board racks may result in property damage.**





**COMFORT AND  
CONVENIENCE**

# STEREO COMPONENTS



## Models

Optional on NXT Series and ProStar. Standard on all other models.

## Purpose

The stereo system provides enhanced enjoyment of the boating experience. The system includes a stereo AM/FM radio, remote controls, USB, Auxiliary and Bluetooth connections, and may include a subwoofer and amps.

## Location

The stereo system operates either through the touch display on the Dual Screen Dash, or through a radio head unit mounted to the dash. NXT Series boats have the head units mounted on the left hand side of the dash.

Optional remote controls are available for mounting to the transom of all models.

The USB plug-in is located on the throttle panel for all stereo configurations. Subwoofer and amp locations vary by model. (See the Guide to Individual Models of this Owner's Manual to determine location for your individual model.)

## Special Attention

Tampering with the factory audio setup on any stereo-related equipment will void the manufacturer's warranty, and will cause the system to malfunction. The system is set up such that aftermarket stereo equipment cannot be added to the system. DO NOT attempt to add after-market stereo equipment to the boat. Stereo upgrades can be performed by your dealer in certain circumstances. Contact your authorized MasterCraft dealer for more information.

## Operation

The stereo and components come with a separate manual explaining operation of the devices. Please review and become familiar with these manuals and the stereo equipment.

The USB interface option allows the unit to simply be plugged in and run off the boat's electrical system. USB plug-ins are mounted below the throttle on the throttle panel.

**Be aware that all such devices are a drain on the boat's battery and electrical system. Care should be taken to avoid excessive usage of such devices and by responding to any alarms that sound so that the boat's battery(ies) do not become fully discharged.**

# WIRELESS CHARGING



## Models

Two types of wireless charging devices are found on MasterCraft boats: wireless helm chargers and wireless cockpit chargers. The wireless helm charging system is a standard feature on X, XT, X Star, and ProStar models; optional for NXT models. The wireless cockpit charging system is optional for the NXT, XT, X, and X Star.

## Purpose

The wireless charging system provides convenient charging for compatible smartphones while on the water.

## Location

The wireless helm charger is located at the helm of the boat, inside the helm phone holder. Wireless cockpit chargers are located inside a pair of plastic phone holders directly above the drink holders in the port and starboard side compartments.

## Operation

To use one of the wireless chargers, simply place your phone in the phone holder. The phone should immediately begin to charge. If it does not charge, remove the case and try again.

# GLOVE BOX

## Models

The glove box is a standard feature on all models.

## Purpose

The glove box provides easily accessible storage space for small items. MasterCraft recommends that you keep this Owner's Manual in a water-resistant plastic bag inside the glove box so that it is quick to find in the event that troubleshooting for any part of the boat is required.

## Location

The glove box is located on the port side of the dash, forward of the observer seat.

## Operation

The design of the glove box varies depending on the model. All have a closable lid. To open the glove box lids that feature a recessed button, simply push in on the button. A twist knob will pop up. Twist the knob to disengage the lid from the box.

## Special Attention

Glove box lids should always be closed and latched any time the boat is in operation. While the boxes are water resistant, if the lid is not latched securely water can intrude and cause damage to anything inside the glove box. MasterCraft is not responsible for such damage. Any items placed in the glove box that cannot or should not become wet should be placed in water tight containers before placing them inside the glove box.

## Troubleshooting

Any time the lid will not close and latch properly, see an authorized MasterCraft dealer. If it is not properly closed, damage could occur to the lid.

# HEATER

## Models

All models, as an option.

## Purpose

Warmed air from an electrically powered heater box will be blown from vents within the boat deck, to keep occupants warm.

## Location

Heater vent locations vary by model, but all are located within the cockpit. They typically reside in the driver's floor, either side of the cockpit in the cup holder inserts, and/or on the observer dash near the glove box. A heater tube and vent is typically installed near the floor.

## Operation

The heater is controlled through the dual screen dash. It has two settings HIGH and LOW. Tap the heater button to turn the heater ON LOW. Tap the button again to turn the heater ON HIGH. Tapping the heater button again turns it OFF. The heater can only be operated with the engine ON. This prevents excessive battery drain.

## Special Attention

In regular use, the heater should not require any routine maintenance. However, it is advisable to avoid placing items in front of the vents, particularly when the heater is in use. The heated air coming out could cause damage.

Never run the heater in a confined space, such as a garage or shop. Running the heater requires also running the engine; fumes from the engine can be deadly. See also the Common Sense Approach in the Safety section of this Owner's Manual regarding carbon monoxide danger.

See the Storage and Winterization section of this Owner's Manual for winterization instructions.

## **WARNING**

Carbon monoxide is emitted from the engine's exhaust system. Never run the engine without proper ventilation. Do not run the engine in a confined space or where fumes may be trapped.

## **Troubleshooting**

If the heater fails to respond when the switch is turned to either of its ON positions, check on the main circuit breaker panel to ensure that the circuit has not tripped. If resetting does not correct the problem or if it continues to trip, take the boat to an authorized MasterCraft dealer for repair.



# **SEAT HEATERS**

## **Models**

Optional on all models for driver's seat; certain models for observer's seat.

## **Purpose**

The seat heat option allows equipped seats to be warmed to temperatures above those of the ambient air.

## **Location**

The electrical seat-heat mechanisms are located inside equipped seats. The seat heat switch can be found in the helm mounted touchscreen on the Dual Screen Dash. In some models, an optional observer seat heat switch will also be found in the helm mounted touchscreen.

## **Operation**

To turn the seat heater(s) on, navigate to the accessories page on the dash mounted touchscreen. Tap seat heat button to turn the seat ON. The button will change colors to show that the seat heater is ON. Note that the seat heater will only operate with the engine is running.

## **Special Attention**

Do not leave open food, sun tan oil, or other materials on the seats if the seat heat function is ON. Although the heat does not exceed a temperature at which skin can touch without burning, the additional heat could cause some types of food or other materials to melt, causing a stain or damage that is not covered under warranty.

## CAUTION

Do not leave unattended, open food or other materials that could melt, on a seat equipped with a seat heater that is or will be turned ON. The additional heat could cause melting, resulting in a stain or other damage that is not covered under warranty.

## Troubleshooting

If the seat heat system does not work when the switch is ON, check at the main circuit breaker panel to ensure the circuit has not tripped. If so, reset. If the seat heater(s) still does not work or if the circuit continues to trip, take the boat to an authorized MasterCraft dealer.

# ANCHOR



## Models

All models (excluding ProStar) have a bow cleat for securing anchor lines. Anchors are optional on all models

## Purpose

The anchor allows the boat to be temporarily moored in relatively shallow water. Note that standard equipment does not include the line for the anchor. This is because needs will vary considerably by location of the body of water. The general rule of thumb is that the boat owner should purchase anchor line from a marine aftermarket company at a length about three-to-four (3-4) times the depth of the body of water in which the boat will be moored.

## Location

Some models are equipped with anchors, and there will be a designated storage area or stowage location on the boat, normally in the forward area of the bow. Check with your dealer if you are uncertain about this area because it is important to keep the anchor stowed when it is not in use. In some instances, ladders may also be stowed in this location.

## Operation

MasterCraft anchors are manually operated. The anchor has a storage compartment at the front of the bow. After purchasing

and securely attaching a line manufactured to be used in a marine environment as an anchor line, open the anchor storage compartment and remove the anchor. Drop the anchor over the side, ensuring that the anchor does not make contact with the boat deck or hull, as such contact could cause damage to the gel coat, which is not covered under warranty. Also use care in retracting the line and anchor to avoid damaging the deck and/or hull.

Always tie off to the bow. Never tie off solely to any position aft, including the transom.

## CAUTION

The anchor has been provided to assist boaters in remaining in a chosen location. Boats should always be tied off to the bow and never solely to the aft. Note that use of the anchor system will not guarantee a properly anchored boat or that the boat will remain in a stationary position. Environmental, bottom conditions, current and tidal conditions must be taken into consideration when anchoring the boat. Only properly trained operators should set the anchor for this system. Establishing a secure anchorage requires practice. Damage to your boat may result due to improper anchoring techniques.

Swimmers or anyone in the water in the area of the bow should remain aware of the anchor line anytime it is deployed. Even if it appears taut, an individual could become entangled in the line underwater, which could result in injury or death. It is also possible

that people could cause the anchor to lose anchorage, causing the boat to move. If there is a current, the boat could become inaccessible to people in the water.

## WARNING

Whenever the anchor line is deployed, individuals in the water nearby should avoid the line. Disrupting the line could cause the boat to move away from the chosen anchorage location. It is also possible that individuals could become entangled in the anchor line. If underwater, this could result in serious injury or even death.

## Special Attention

MasterCraft suggests that operators monitor and verify the rewinding process to ensure that the line retracted in a smooth and even fashion. Anchors should never be pulled aboard and left on-deck because this can lead to potentially dangerous situations.

## WARNING

Improperly stored anchors and/or anchor lines that have been improperly rewound may create a hazardous situation. People on-board can trip on improperly stored materials, which can result in injury. Improperly stored materials can also move too freely during boat operation and make contact with individuals, again causing



injury. Properly store all anchors and lines whether the boat is in operation or not, any time the anchor and line are not in use. Never operate the boat with the anchor line deployed.

## Troubleshooting

If the anchor line has been improperly rewound, have an authorized MasterCraft dealer assist in deploying and rewinding the line to its appropriate berth.

# CANVAS COVERS



## Models

MasterCraft offers several different styles of canvas covers for varying uses on all models. Bimini tops are designed to provide protection from the sun while operators and passengers are out on the water. Mooring or towing covers protect MasterCraft boats from the elements while towing, docked, or in storage.

## Operation

Most covers are intended for use when the boat is moored or stored. These canvas covers will snap or ratchet into place. For information regarding bimini covers see the bimini section immediately following.

## Special Attention

MasterCraft strongly recommends that only authorized MasterCraft dealers perform the installation of snap-on canvas such as cockpit and tonneau covers. Improper installation of these covers can cause “crazing,” unwanted spider web-like cracks in the gel coat. Such damage is not covered under warranty.

## Additional Special Attention

On-going care is required to keep canvas material in good condition for the life of the boat. See Cleaning the Boat section of this Owner’s Manual for more information.

## Additional Special Attention

Note that towing with unapproved covers on the boat may result in damage to the gel coat. MasterCraft recommends using only approved towable mooring covers when towing. Other canvas covers are available only through authorized MasterCraft dealers for a variety of uses.

## CAUTION

The use of canvas covers, especially dark colored ones, in hot, sunny conditions, can result in temperatures inside the boat in excess of 140°F/60°C. Prolonged high temperatures can heat interior metal and other surfaces to the point that brief contact with the skin may cause serious burns. Carefully remove the cover and allow the interior to ventilate and cool before allowing anyone on board.

# BIMINI CANVAS

## Models

All MasterCraft Models have optional bimini tops. Each tower style has a bimini designed specifically for that tower (ProStar optional windshield mounted bimini).

## Purpose

MasterCraft's bimini is designed to enhance comfort and protect boaters from the sun's rays while on the water.

## Location

Bimini tops are designed and built to match each of MasterCraft's tower options. The bimini is integrated into its respective tower and will usually cover the helm and/or midsection of the boat. Bimini legs and canvas fold to allow minimal wind resistance when towing, during storage or when riding across a body of water at high

speeds. When folding the bimini up or down, be careful to avoid pinching fingers between the support legs.

## Operation

See each tower's respective bimini section immediately following.

## WARNING

When trailering a boat or when operating the boat at high speeds, fold the bimini down to reduce wind resistance. High speeds put large amounts of air pressure on the bimini legs and can cause them to collapse causing serious injury and damage to the boat.

# Z6, Z8, AND Z10 BIMINI



## Models

All boats equipped with a Z6, Z8, or Z10 Tower. Though the biminis look slightly different, they function identically.

## Purpose

The Z6, Z8, and Z10 biminis cast shade on the cockpit of the boat to keep occupants cool and protected from the sun's rays.

## Location

Integrated into the Z6, Z8, and Z10 towers.

## Operation

Biminis come pre-installed from dealers on all models.

### To deploy the Z6, Z8 or Z10 Bimini:

For balance, it is suggested that operators have an additional person assist when raising or lowering a bimini top.

1. Unzip and remove the bimini boot cover.
2. Unclip all clips securing the bimini legs to one another.
3. Unfold and deploy the bimini. The bimini folds forward away from the tower.
4. Zip all of the zippers on the aft portion of the canvas around the forward most tower tube.
5. Buckle all straps around the tower loosely.
6. Fully extend the bimini legs and ensure that they are locked into place.
7. Tighten all straps and buckles around the tower so that the canvas is stretched tightly around the tower.

**Collapsing the bimini is the opposite of deploying it:**

1. Unlock the bimini legs and let them fold forward loosely.
2. Loosen and unclip all buckles around the tower tubes and supports.
3. Unzip all zippers around the tower tubes.
4. Fold the bimini and canvas up to the tower.
5. Use the gray leg clips to keep the bimini legs locked together.
6. Cover the bimini with the protective boot and zip the boot around the canvas.

## Troubleshooting

Should the bimini ever bind or become locked in either the stowed or deployed position, MasterCraft recommends that the bimini be taken to an authorized MasterCraft dealer for repair. Improper use may bend or deform the bimini frames, or may rip the bimini canvas. Misuse is not covered under the warranty.

# PROSTAR BIMINI

## Models

ProStar

## Purpose

The ProStar bimini casts shade on the cockpit of the boat to keep occupants cool and protected from the sun's rays.

## Location

Mounted to the ProStar's windshield.

## Operation

For balance, it is suggested that operators have an additional person assist when raising or lowering a bimini top.

### To install the ProStar bimini:

1. Let the bimini canvas rest on top of the motor box with the legs facing towards the bow of the boat.
2. With another person, line up the main bimini legs (the longest leg on both sides of the bimini) with the mounting brackets on the port and starboard sides of the windshield frame. Ensure that the ball joint is facing upwards (see photo).



3. Insert the ball joint into the bracket and insert the pin to lock the bimini legs to the mounting bracket. To ensure proper orientation see the photo below.
4. The bimini should rest on the support poles supplied at delivery.

### To deploy the ProStar bimini:

1. With the main bimini legs mounted to the windshield, lift the

topmost portion of bimini frame forward (the rest of the bimini and frame will follow) until the main bimini leg touches the top corners of the windshield.

2. With some upward pressure on the main bimini leg, slide the secondary mounting ball joints down into the top of the windshield's corners.

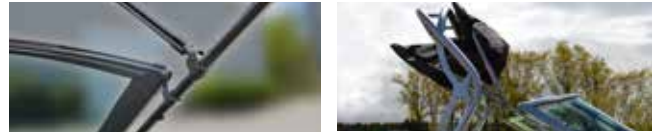

3. Fully extend the bimini supports on either side until they lock into place. Ensure that the bimini supports lock into place before operating the boat.

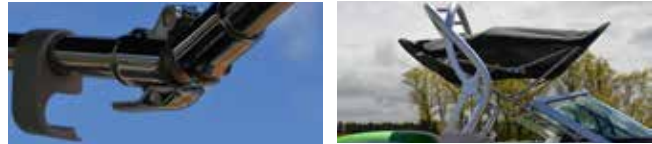

### To stow the bimini:

1. Unlock the bimini support legs.
2. With upward pressure on the main bimini leg, slide the secondary mounting ball joint upwards on the bimini leg until it is clear of the windshield.
3. Fold the bimini down to rest on the support poles.
4. Wrap the bimini boot cover around the bimini and zip closed.

## Troubleshooting

Should the bimini ever bind or become locked in either the stowed or deployed position, MasterCraft recommends that the bimini be taken to an authorized MasterCraft dealer for repair.

# TRANSOM/SWIM PLATFORM CANVAS

## Models

All X, XT, and Star series models as an option with the “Under-tower Mooring Cover.”

## Purpose

Cover and protect the swim platform from the elements.

## Location

Attached to the mooring cover and over the swim platform

## Operation

Utilize the Velcro flaps connected on the swim platform cover and the aft portion of the mooring cover to attach the two pieces together. Open the flap on the mooring cover, insert the flap of from the swim platform cover and sandwich the two together, pressing firmly to ensure a tight attachment. Once all flaps are connected, pull the

platform cover over and around the aft section of the swim platform. Pull the drawstring under the cover to tighten.

**NOTE: The transom/swim platform canvas is purposely loose in order for the operator to be able to step on the canvas for installation/removal.**

## CAUTION

The transom / swim platform canvas must be removed before trailering, as it may damage gel coat.

# MOORING COVER WITH ANTI-POOLING SYSTEM

## Models

Under tower and over tower mooring covers are optional on all X, XT and NXT Series models.

## Purpose

Anti-pooling boat covers are designed to prevent water and debris intrusion while the boat is docked or stored. Mooring covers mount around the boat and cover everything above the stainless steel rubrail.

Under tower mooring covers feature an integrated anti-pooling

system that lifts the cover up so that snow or water drains off the side rather than pooling on top of the cover. Anti-pooling covers use a drawstring system to lift the canvas mooring cover up towards the tower. The anti-pooling cover is designed to be used in conjunction with anti-pooling poles during long-term storage, or on long road trips. Poles are required when trailering the boat for trips lasting more than one (1) hour, at speeds over 70 MPH. Poles are also required for use with the mooring cover for long term and seasonal storage.

## Location

Mooring covers mount over the boat and use ratcheting straps to secure them snugly around the boat. The anti-pooling system on under tower covers loops over the tower tow point and is secured in place by pulling on the drawstring mounted to the aft portion of the canvas.

## Operation

### To install a boat cover with the anti-pooling drawstring:

1. Cover the bow and the forward portion of the cockpit with the canvas designed to fit the bow.
2. Continue covering the boat from bow to stern until you reach the windshield. Ensure that the windshield door is closed. Continue covering the boat.

3. When you reach the tower base, mount the neoprene anti-pooling loop over the tow point on the tower.



4. Buckle the buckles on both sides of the tower and ensure that the velcro is secured around the tower legs.



5. Cover the rest of the boat to the transom. Pull the canvas down below the rubrail on XT and NXT models and use the ratcheting straps to secure the cover onto the boat. Ratchet the straps until

they cannot be tightened further. The cover is designed to ratchet very tight.

For X Series models pull the cover down below the style line as pictured. Use the ratcheting straps to secure the cover in place.



Correct Placement - NXT Series



Correct Placement - XT Series



Correct Placement - X Series



Incorrect Placement - X Series

6. Unzip the rope cleat cover and pull aft on the drawstring until the cover is lifted up towards the tower, such that there are no portions of the canvas that sag into the boat. Secure the

drawstring to the rope cleat on the cover. Zip the rope cleat cover to prevent water intrusion.



**NOTE:** Covers are custom designed for each boat model. Your cover has bow and stern sections that match the layout of your boat. It is critical that the cover is oriented properly when installing.

## CAUTION

Failure to use anti-pooling poles to support the mooring cover during storage, or while trailering the boat could cause damage to the mooring cover, the boat, or the trailer.

# EXTENDABLE SUNSHADE FORWARD AND AFT



## Models

XT22, XT23, XT25, X22, X24, X26 and XStar models equipped with Z8 or Z10 towers.

## Purpose

The extendable sunshades provide additional shade when the boat is at rest to keep occupants cool and protected from the sun's rays.

## Location

Removable shades mount to either the front or back of the bimini to provide additional shade. When not deployed, they can be stored in the provided storage bags and be placed under seating.

## Operation



### SUNSHADE FOR USE WHEN THE BOAT IS NOT IN MOTION!

The sunshades mount to the bimini using a series of buckles and tension poles. To install the poles into the deck:

#### To install the forward sunshade:

1. Remove the sunshade and poles from the storage bags.
2. Unfold and lay out the sunshade with the buckles facing the tower. Ensure that the material is facing the correct side up.
3. Insert the tension poles into the gunnel mounting points. Ensure that they are properly seated in the mount.





4. Lay the wide part (with the buckles) of the sunshade over the forward edge of the bimini.



5. Buckle the straps around the middle support arm of the bimini on each side, ensuring that the sunshade remains on the top of the bimini.



6. Move to the forward end of the shade. Stretch the canvas forward so that the metal rings can be mounted on the tension poles.
7. Mount the metal rings around the tension poles. Pull the tension pole slightly toward you to make mounting the metal ring is easier.



8. After mounting the metal ring on the tension pole, release the tension on the pole slowly so that it returns to a vertical position.



#### To install the aft sunshade:

1. Remove the sunshade and poles from the storage bags.
2. Un-fold and lay out the sunshade with the buckles facing the tower. Ensure that the material is facing the correct side up.
3. Insert the tension poles into the gunnel mounting points. Ensure that they are properly seated in the mount.



4. Attach the sunshade to the tower using the buckles that are provided on one end of the sunshade. Use the images below as a guide, and note that the two widest buckles wrap around the surf tow point. With the outside straps in place, the rest will line up where they mount.



5. Move to the aft end of the shade. Stretch the canvas aft so that the metal rings can be mounted on the tension poles.



6. Mount the metal rings around the tension poles. Pull the tension pole slightly towards you to make mounting the metal ring easier.



7. After mounting the metal ring on the tension pole, release the tension on the pole slowly so that it returns to a vertical position.
8. Adjust the buckles as necessary to ensure that the shade is taut, but not putting undue stress on the tension poles.



## BIMINI SIDE SHADES



### Models

Bimini side shades are an optional feature for NXT, XT, X, and X Star models. They are compatible with Z6, Z8, and Z10 towers.

### Purpose

Attaching to the sides of the canvas top, bimini side shades offer additional protection from heat and sunlight. The operator may adjust the side shades' coverage angle to achieve maximum protection any time of day, keeping UV light out of the cockpit when the sun is low in the sky. The shades are constructed from Phifertex, an anti-microbial fabric with UV-resistant properties.

## Location

Once installed, the bimini side shades attach to the sides of the canvas top and extend over the port and starboard sides of the boat to provide cockpit shade. They have a jaw slide attachment point on the bimini arm, as well as several tie downs along the bimini frame, tower, and stern/bow cleats. Prior to assembly and installation, the side shades are stowed in a black drawstring bag.

## Installation

The shades are stowed in a black drawstring bag. Inside this bag are a mesh canvas and metal frame. Attach the mesh to the frame by slipping the side pole into the sleeves. Now that the shades are assembled, follow these steps to install them:

1. Lay the side shade out across the sun pad. Position the shade so that the side pole is more or less parallel with the windshield. The mesh should form the top layer, facing upward, with the frame underneath and touching the sun pad.



2. Notice that the side pole is divided into two sections and that a loose pin is attached to each section. Drive the pins into the stops along the surface of the pole while driving the two halves together. Connect them and lock the side pole in place.



3. An extendable center support pole is connected to the middle of the side pole. Prior to installation, make sure the stops along the side of the center support pole are facing downward.
4. Make sure the center support pole is drawn all the way out. This is accomplished by holding the trigger on the side of the pole and simultaneously drawing the pole outwards.



5. Locate the aft slip lock on the bottom corner of the mesh. Buckle it around the outermost crossmember of the tower tube.



7. Locate the jaw slide on the foremost bimini arm. Remove the pin from the jaw slide.
8. Attach the center support pole to the jaw slide. Navigate the support pole to the jaw slide on the bimini arm and slip the ball joint into the jaw slide. Reinsert the pin to lock in place.



9. Locate the stern cleat strap. Attach it to the stern cleat by drawing the looped section under and around the cleat.



10. Locate the other slip lock and buckle the ends around the top foremost corner of the bimini frame.



11. Find the bow cleat strap. Attach to the bow cleat.
12. The side shade is now installed. Repeat the same installation process for the other side of the boat.

## Operation

After you have assembled and deployed the side shades, you may want to adjust the coverage angle depending on the time of day. A lower coverage angle, for example, will benefit passengers at hours when the sun appears lower in the sky. To adjust the coverage angle, locate the trigger on the center support pole; then, pressing down on the trigger, extend or retract the pole as needed.

In addition to modifying the coverage angle, you will sometimes need to position the bimini side shades fully upright when docking the boat. This will ensure clearance and prevent collision with onshore objects, such as fueling stations. To prepare the side shades for docking, follow the steps listed below:

1. Undo the bow cleat strap.
2. Without removing the pin from the jaw slide, draw the center pole towards you, upright against the bimini frame.



3. Keep the center support pole upright against the bimini frame. Use a slip lock to buckle the center pole around the tower leg. Tighten and adjust the slip lock as needed.
4. The side shades are now prepared for safe docking. They should resemble the example pictured below.



## Additional Information

Owners and operators should keep the following in mind before using the bimini side shades. On all powerboats under 39.4 feet in length (12 meters), it is required by the U.S. Coast Guard that the masthead light should cover 225 degrees and remain visible for 2 nautical miles. When the bimini side shades are deployed fully upright against the boat, the masthead light is obstructed, potentially violating the U.S.C.G.'s rule on this matter.

Therefore, to avoid conflict with the U.S.C.G., owners and operators should **never** drive their boat while the side shades are deployed upright. This angle should **only** be used when the boat is in the process of docking. In any other operational circumstances, upright deployment is unacceptable and should be avoided.



**An unobstructed masthead light can protect those onboard from potential collision incidents. Therefore, it is highly important that you observe the above guidelines regarding side shades. Except when docking the boat, the side shades should never be deployed upright under any operational circumstances.**

# ENGINE FLUSH

## Models

The engine flush is standard on all models.

## Purpose

Boats that will be operated in salt water (or brackish fresh water) need to be rinsed after every use, including internal engine parts where water has been drawn.

## Location

The engine flush connection is mounted on the pylon brace cross-bar inside the engine hatch.

## Operation

The engine flush connection allows for quick and easy connection to a shore-side garden hose or similar hose to quickly and easily flush the engine. See the ILMOR Engine Owner's Manual for additional details regarding this important function. The flush connection is located on the transom.

## Troubleshooting

If a hose will not connect to the flush connection, locate a different hose. Garden hoses work fine as long as the hose end is not bent or misshapen.

If water will not enter through the flush connection, disconnect the hose and check that there is no obstruction in the connection area.

If there is no obvious reason for the system malfunction, take the boat to an authorized MasterCraft dealer for assistance.

# HEAD AND TOILET SYSTEM

## Model

X26, as an option

## Purpose

The on-board head provides convenience for longer outings.

## Location

The head is located forward of the observer seat, accessible through a door that opens into the walk-thru area to the bow.

## Operation

This boat is equipped with an Dometic Masterflush electric mac-



erating toilet. The Masterflush toilet has a rugged glass filled nylon twin impeller that instantly draws in the effluent into the macerating chamber where the waste is pulverized by a 10-blade stainless steel cutting wheel and ejects it into the waste tank on the starboard side of the boat via a short run of premium sanitation hose.



## Toilet system start-up

1. Turn on fresh water pump switch at the helm side panel.



2. Press “Flush” switch and hold for at least 10 seconds.
3. Toss several sheets of toilet paper into bowl and repeat cycle. The bowl should completely clear.

## Normal flushing

### FLUSHING TOILET

Press “Flush” switch (bottom switch) down and hold until waste drains from toilet bowl (about 10 – 20 seconds). This switch activates a macerator pump that siphons water and waste from the bowl, macerates, and propels the effluent to the discharge line/holding tank.

## CAUTION

Do not flush waste with “Dry Bowl” Switch! To maintain proper cleanliness and operation of the toilet and macerator pump, water should be used with every flush.

## Toilet operation when connected to tank monitor system

A tank monitor is located in the head module on the vanity face. It has LED indicators that show empty, low, medium and full.

Never flush the toilet if the indicator shows the holding tank is full.

Empty the waste tank using dockside pump-out or optional over-board discharge (3 miles offshore).



## CAUTION

Do not flush foreign objects! Flush only water, bodily wastes and rapid-dissolving toilet tissue. Do not flush wet wipes, sanitary napkins, condoms, diapers, paper cups, cotton swabs, food, hair or liquids such as oils or solvents as clogging or damage to the toilet or toilet system may occur.

## CAUTION

Hazard of Flooding If toilet is connected to ANY through-the-hull fittings, ALWAYS close seacocks when toilet is not in use (even if boat

is unattended for a brief period). All passengers **MUST** be instructed on how to close valves when the toilet is not in use. Failure to do so can result in flooding which can cause loss of property and life.

**NOTE: Make sure all guests understand toilet operation before use.**

## To empty the waste holding tank

### Dockside pump out

The dockside pump out connection is located on the starboard side forward deck in front of the windshield.

4. Open the deck plate.
5. Dock/or fit suction hose from the pump out station or marina into the deck plate.
6. Turn on suction pump and monitor the tank level fullness on the waste tank monitor in the head compartment.
7. Turn off pump when the monitor reads empty.

The pickup goes to the bottom of the tank and will get most but not 100% of the waste out of the tank.

The tank is protected with Vacuum relief valve to prevent the tank from imploding from dockside pumps that generate huge vacuums.

### Optional Overboard Discharge

The boat may be equipped with optional overboard discharge system to allow waste to be pumped out the bottom of the boat if you are more than 3 miles offshore or in an area where it is legal to

dump waste. Check your local regulations to be sure.

1. Open the overboard shutoff valve located under the center floor locker hatch in the walk-through area of the boat.
2. Lift the starboard side bow lounge seat in front of the driver.
3. Insert key into pump switch panel located under this seat.
4. Turn the key clockwise and hold to operate the discharge pump. The switch is spring loaded and must be held to run the pump.
5. Run the pump until the tank level monitor reads empty.
6. Close the overboard shutoff valve.
7. The overboard discharge pump is located in the same area as the key switch, under the starboard side bow lounge seat in front of the driver.

## Cleaning the toilet

To maintain the toilet's original appearance, use Dometic® Toilet Bowl Cleaner or other non-abrasive bathroom and toilet bowl cleaners. Please follow label directions.

## CAUTION

**To avoid damaging internal seals, do not clean toilet with abrasive cleaners, caustic chemicals, or lubricants and cleaners that contain alcohols or petroleum distillates.**

## Routine maintenance

### Monthly

1. Inspect toilet, plumbing, and plumbing connections, wires, and wire connections.
2. Open and close all plumbing valves, including seacocks.
3. Check in-line water filters and vented loops for blockage.

### Yearly

Check water valve filter. Also check water valve filter if water flow into toilet becomes insufficient.

## During extended periods of non-use

The macerator toilet and sanitation hoses should be protected if toilet will not be needed for an extended period of time (more than two weeks, especially in hot weather).

1. Flush toilet and add 4 oz. (118 ml) of liquid biodegradable laundry detergent (the detergent should NOT contain bleach or environmentally harmful substances). Note: If using sea water for flushing, shut off power to sea water pump and add fresh water directly into the bowl during the flush cycle.
2. Flush toilet at least five times.
3. Turn off water supply to toilet.
4. Flush the toilet without water very briefly to evacuate all water. (This procedure will minimize any remaining water in the macerator pump.)

5. Turn off power to the toilet.
6. After extended periods of non-use, toilet and pump may dry. For easier re-start of toilet system, add one quart of water to bowl and let it stand for a few minutes before use.

## CAUTION

**During water evacuation process, do not operate sea water pump very long without water. Pump impeller may become damaged.**

## Winterizing Toilet System

At the end of each season, the macerator toilet should be winterized for storage by using potable water-safe antifreeze (if boat will be exposed to freezing temperatures).

If system will be subjected to freezing temperatures, please follow procedures in this section, "During extended periods of non-use", and then winterize system as described here.

**NOTE: Use nontoxic antifreeze designated for potable water systems.**

### Fresh water system

1. Drain potable water tank and empty holding tank.
2. Add freshwater antifreeze to potable water tank.
3. Flush potable water antifreeze and water mixture through toilet(s) and into entire system, including the waste holding tank, diverter

valve connections, discharge pumps, etc. Turn off power to toilet. Each installation is different, so amounts may vary. User discretion is required to assure adequate protection.

## CAUTION

Never use automotive-type antifreeze in freshwater systems.

### Special Attention

Use only rapid-dissolve toilet paper with these head systems, and only deodorant specially formulated for this type of head system. See the manufacturer's instructions for details. In the event that anything from the head's bowl or holding tank escapes, it should be cleaned as soon as practical. Failure to clean any spillage may result in unpleasant odors, mildew, mold and damage to the deck or other areas of the boat. This is not covered under warranty.

### Troubleshooting

If the toilet flushes but the water in bowl empties slowly or not at all, check the discharge piping for kinks and blockages, and the macerator pump for blockages. If the macerator pump makes unusually loud noises, or continually trips the circuit breaker, then check the pump for foreign material. If the toilet doesn't flush after pushing the flush switch, check the tank to see if it is full, check if the circuit breaker has tripped and needs to be reset. If the toilet doesn't re-

ceive water when the flush button is pushed, check the water supply line to make sure it isn't kinked and check the water valve screen to make sure it isn't blocked. If the toilet still exhibits issues, then present the boat to an authorized MasterCraft dealer for repair.

## REMOVABLE COOLERS



### Models

Standard on all XStar, X, XT and NXT Series boats. Optional upgraded cooler available for all XStar, X and XT Series models.

### Purpose

The cooler allows boaters to bring food and beverage on-board for outings and keep such items at a lower temperature than ambient air to prevent spoilage.

## Location

Vary by model. See the Guide to Individual Models in this Owner's Manual to determine the location in your model.

## Operation

In using the cooler, ensure that the lid is securely closed prior to operation of the boat. If the lid is not secure, water, ice and food/beverage items may become dislodged and spill into the void where the cooler is stored. Be sure to keep the cooler in the designated location as shown in the Guide to Individual Models in this Owner's Manual. Coolers that are placed in other locations, including on the deck, are not secure. While the coolers themselves have minimal weight, if they contain ice, food and beverage, the combined weight can cause injury if the cooler moves around during operation.

### CAUTION

**Coolers should always be stowed in the appropriate designated location of the boat as noted in the Guide to Individual Models section of this Owner's Manual. Stocked coolers can have enough weight to cause imbalance in the boat and/or cause injury upon contact.**

NOTE: 2015 and newer models have shock assisted cooler cushions to eliminate the need to hold the cushion up while removing and installing the cooler, as well as accessing the cooler for beverages/food. The shock could have reduced performance if

the cooler cushion is saturated with water. Also, if the seat hinges become misaligned, and the shock interferes with the clearance hole, the hinge may be damaged or the substrate or seat base may be deformed.

## Special Attention

As with any similar coolers, routine cleaning with warm soapy water is advised after each use. Check whether anything from inside the cooler has been spilled or in some manner ended up in the storage area in which the cooler is kept. This should be cleaned up immediately to avoid mold, mildew, stains or other damage that is not covered under warranty.

Food items or anything that can create an odor or leak should not be left in the cooler, as they could damage the cooler. This type of damage is not covered under warranty.

### CAUTION

**Clean the cooler (and the storage compartment in which the cooler is stored) after each outing in which the cooler is used. Failure to do so can cause damage that is not covered under warranty.**

## Additional Special Attention

Do not drink water from melted ice or water that is not in containers. The cooler may contain contaminants.

# REFRIGERATION



## Model

X26, as an option.

## Purpose

The refrigerator is suitable for cooling food and beverages for a day on the water.

## Location

The refrigerator unit is located immediately aft of the driver's seat, replacing some storage space.

## Operation

The refrigerator operates by opening the cool box drawer and turning the thermostat knob clockwise. Shutting it off requires turning the thermostat knob counterclockwise. A booklet from the manufacturer is also supplied in your owner's packet. Please review it prior to operating the refrigerator for the first time.

## Special Attention

Note that the refrigerator functions off the boat's electrical system. Attention should be paid to the voltmeter(s) to be certain that these systems do not over-drain the electrical system.

## Additional Special Attention

Food items or anything that can create an odor or leak should not be left in the refrigerator or cold plate areas, as they could damage the units. This type of damage is not covered under warranty. The condenser on the refrigerator should be kept free of dust, dirt and anything that inhibits its proper operation. The manufacturer also recommends leaving the door slightly open if it will not be used for an indeterminate period of time. This helps prevent unpleasant odors from forming. Refrigerator cleaning instructions have been provided by the manufacturer. Note that it should always be OFF, and should never be cleaned under flowing water or submerged in any kind of body of water. Do not use abrasive cleaning agents. If it is necessary to defrost the interior, never remove layers of ice with hard or sharp tools because they can damage the plastic of the vaporizer. Allow the unit to air defrost.

## Troubleshooting

If the refrigerator will not turn ON and cool, check the main circuit breaker box to ensure that the electrical circuit powering the refrigerator has not tripped. Re-set as necessary. If the system still does not work or continues to trip, see an authorized MasterCraft dealer.

If the refrigerator stops working during an outing, move any items inside to a cooler. The cooling inside the fridge will last for a short time, but items that require cooling to keep from spoilage may not be kept at a proper temperature for long enough. Foods or medicines that require cooling but have been in the refrigerator without it operating for a period of time should be discarded without use.

**MasterCraft assumes no responsibility for spoilage resulting from an inoperable refrigerator or failure to follow directions in use of the refrigerator.**

## WET BAR



## Model

X26, as an option

## Purpose

The wet bar offers an area in which fresh water can be accessed, as well as allowing water to be conveniently drained.

## Location

The wet bar is located immediately aft of the driver's seat.

## Operation

Ensure that there is water in the freshwater tank (see Shower and Wash Down information elsewhere in this section of the Owner's Manual). Flip open the lid to allow access to the sink area. The knobs turn as they do on land-based faucets. Note that the water is pressurized so it will come out of the faucet similar to a land-based sink, with slightly less force. The sink drains through the boat's bilge system.

Water available is limited to the amount in the freshwater tank, water from the body in which you are boating is not brought aboard through this system.

Ensure that the faucet is OFF and the lid secured prior to operation of the boat. Leaving the lid up while underway can result in damage that is not covered under warranty.

## Special Attention

As noted in the Storage and Winterization section of this Owner's Manual, it is extremely important to ensure that there is no water in the freshwater system, which includes the wet bar, during extended storage (at least two weeks without use). Failure to drain the water can result in foul odors, mildew and mold, or other damage that is not covered under warranty.

## Additional Special Attention

If other liquid beverages beyond water are poured down the sink, flush with water to avoid the potential development of unpleasant odors which can develop after the system has not be used for an indeterminate amount of time.

## Troubleshooting

If no water is forthcoming when the faucet is turned ON at the wet bar, verify that there is still water in the freshwater tank. Also, verify that the circuit has not tripped on the main circuit breaker board. If there is water available and the electrical circuit is functional but the system still does not work, have an authorized MasterCraft dealer check the system (the pump is inaccessible to consumers). If the sink does not drain, verify that there is no visible obstruction. If none is evident, take the boat to an authorized MasterCraft dealer for service. **NEVER** pour drain opener or any caustic substance down the drain or otherwise try to open a clog. This can cause significant damage to the system, which is not covered under warranty.

## CAUTION

**DO NOT** pour any drain opener or caustic substance down the wet bar drain. Do not use a plumber's snake or other device to try to open a malfunctioning drain. Any obstruction that is not clearly visible must be removed by an authorized MasterCraft dealer only. Any other attempt to open the drain will likely result in damage to the system that is not covered under warranty.

## STORAGE SPACE



## Models

All



## Purpose

Storage space is integrated into all models to allow onboard gear to be stored safely while the boat is underway.

## Location

Storage areas vary by model. See the Guide to Individual Models section of this Owner's Manual and also check with your authorized MasterCraft dealer to verify the exact locations on your model. Use only designated storage compartments for storage. Using any other space could result in damage to boat equipment and could cause a malfunction of boat systems. Items should always be stowed when the boat is underway to avoid the potential for injury from items dislodged or moving around as a result. Use only designated storage areas to stow items. Use of any other space could result in damage to boat systems that is not covered under warranty. Malfunctions of boat systems could also affect control of the boat, which could result in injury or death. Do not overfill storage areas. Do not try to force doors, cushions or other methods of closure because it can result in damage that is not covered by warranty. Pay attention to the total weight allowance for your boat model and do not include items in storage that will exceed that limit, even if such items will fit in the storage compartment(s). Also note that balance is extremely important and the combination of on-board gear and materials plus the combined weight of persons on-board affects balance. Items and people should be spread out in the boat to ensure safe maneuvering.

## CAUTION

Food items or anything that can create an odor should not be left in storage compartments. Do not leave items that can leak inside the storage compartments, these items could damage the compartment. This type of damage is not covered under warranty. Storage compartments require periodic cleaning. See Care and Maintenance in this Owner's Manual for additional information.

# LADDERS

## Models

Standard on select models; optional on select X, XT, and NXT models.

## Purpose

Ladders allow for easier boarding of the boat from the water. A ladder mounted to a swim platform should only be used for onboarding when the boat engine is OFF. See the Safety section of this Owner's Manual for additional details regarding carbon monoxide poisoning.

## Location

Ladders are mounted under the swim platform.

## Operation

Ladders have a stowable position and an operational position. The swim platform ladder stows under the swim platform. Slide it out and extend the sections. Stow it by sliding back under the swim platform and engaging the slide lock.

Be sure to stow ladders securely prior to operation of the boat. Pressure from the water while underway could damage the ladder.

## Special Attention

When opening or closing the ladder, be careful not to pinch fingers or other skin between the ladder joints or the ladder and the platform. All ladders feature a catch system to hold the ladder in position and provide protection for people as they board.

## Troubleshooting

If the ladder will not extend or fold back into stowed position, take the boat to an authorized MasterCraft dealer for repair.

# SEATING/BOW LID

## Models

ProStar, as an option

## Purpose

Bow seating is standard. The ProStar boat may come with an optional bow lid. This lid provides aesthetic appeal to the boat and pays homage to the great tournament towing boats of yesteryear. Boats equipped with the bow lid have storage space beneath it, accessible from the walkway between the helm and observer dashes. No more than 300 total pounds of gear should ever be placed in this storage compartment. Failure to maintain proper weight balance in the boat can lead to a loss of control that can result in serious injury or death.

## Location

Bow of the ProStar



**All occupants must be seated in designated safe seating as illustrated on the seating chart decal.**

No other areas should be used during operation, including, but not limited to, the gunwales, towers, sun pads, engine boxes, or any area



that is not clearly intended for seating while the boat is underway. People can become dislodged from locations that are not actual seating, which could result in falls in the boat or overboard, resulting in serious injury or death.

## Operation

Carefully read the Seating information which follows immediately in this Owner's Manual. Important safety information is included in that section. Care must always be taken to avoid blocking the view of the boat operator when the boat is underway. All individuals in the boat must be seated and weight properly distributed to avoid complications that can result in serious injury or death. The lid is not intended to be used as additional seating. Allowing individuals to move about or sit on the lid could result in damage to the lid that is not covered under warranty.



## **WARNING**

**All boats have weight limits. Failure to adhere to the posted limits can cause operation instability and/or the boat to sink. This may result in serious injury or death, as well as significant damage to the boat, which will not be covered by warranty.**

## Special Attention

In the center of the bow is an anti-skid walkway to the bow tip. The bow lid is designed to add storage to the bow of the boat and to allow swimmers access to the body of water. Individuals should use this walkway only when the boat is stopped and the engine is OFF. Walking on the walkway or exiting the boat from the bow nose at any time when the boat is running could result in an individual falling from the boat, or being run over by the boat. This could result in

serious injury or death!



**Never allow individuals to walk on the bow walkway or anyone to exit the boat from the bow tip unless the boat is stopped and the engine is OFF. Failure to adhere to this instruction could result in serious injury or death!**

# SEATING

## Models

All

## Purpose

Comfortable seating is a hallmark of all MasterCraft models. Not only does the seating enhance the overall boating experience, but it also is the designated area for operators and passengers to occupy while the boat is underway.



**All occupants must be seated in designated safe seating as illustrated on the seating chart decal.**

No other areas should be used during operation, including, but not limited to, the gunwales, towers, sun pads, engine boxes, or any area that is not clearly intended for seating while the boat is underway. People can become dislodged from locations that are not actual seating, which could result in falls in the boat or overboard, resulting in serious injury or death.

## Location

All models have seating inside the deck area and bow area. Some boats also have seating on the sun deck, convertible seating, and optional walk-thru area jump seats. Verify with your authorized MasterCraft dealer the extent to which the seating is considered acceptable for use while the boat is underway.

## Operation

Some specialized, optional seating adds more comfort. Convertible seats allow the seat back to be moved forward or back, changing the orientation. (Be sure that the seat back locking mechanism is securely engaged before using the seat back in these types of seating. Failure to engage the locking mechanism may allow unintended movement that could result in a person losing balance or even falling.)

The convertible seat backs at the transom and the molded transom lounge seats are intended to be used only when the boat is stationary and the engine is OFF. The seat backs must be in the stowed position when the engine is running or the boat is underway. Positioned aft facing, the seat back offers no security to persons seated at the back of the boat and they could slide off and into the water, with the possibility of making contact with the transom or swim platform, which could result in injury. The engine should be off when individuals occupy rear facing transom seating, individuals may be exposed to carbon monoxide if the engine is running.

## DANGER

Carbon monoxide is a colorless, tasteless, odorless and poisonous gas that accumulates rapidly and can cause serious injury or death. Exposure to carbon monoxide can be fatal in a matter of minutes. Exposure to even low concentrations of carbon monoxide must not be ignored because the effects of exposure to carbon monoxide can build up and be just as lethal as high concentrations. Carbon Monoxide from exhaust pipes of inboard or outboard engines may build up inside and outside the boat in areas near exhaust vents, particularly during slow-speed operations. **STAY AWAY** from these exhaust vent areas, which are located at the stern of the boat when the boat engine is running.

## CAUTION

**Aft-facing seat backs at the transom or sun pad should always be in the stowed position when the boat is underway. Anyone seated facing aft could become dislodged when the boat is underway, which could result in sliding off the seating and making contact with the transom or swim platform. Jump seats should be secured against the deck with a lock pin accessible under the observer seat to avoid dislodging passengers while the boat is underway. Removable seat backing should always be secured prior to use. Care should be taken to avoid pinching fingers or other skin when sliding the backing or securing/removing the removable seats.**

## Special Attention

In models equipped with a judge's seat, the observer seat must always be closed prior to any adjustments to the judge's seat back rest, including installing or removing the seat. Failure to close the observer seat can result in damage to the observer seat upholstery. Such damage may not be covered by the warranty.

## Special Attention

In some models, removable cushions are available as an option. In those instances, regardless of where the cushions are custom-built to be placed, they will be constructed of the same materials as the rest of the upholstery material. That means that they will require the

same cleaning and care. (See Care and Maintenance upholstery information in this Owner's Manual.) Removable cushions should also be stowed in storage when the boat is underway unless they are snapped into position. Failure to stow or snap removable cushions could result in the cushion being lost overboard.

Another attractive feature on some boat models is the folding arm rest, normally found in the bow section. These arm rests are padded with durable upholstery, which requires the same type of care as all of the boat's upholstery. (See Care and Maintenance upholstery information in this Owner's Manual.)

## GAS ASSISTED SEAT LIFT



### Models

XT20, XT21, XT22 XT23, X20, X26 and XStar, as an option

### Purpose

Allow the helm seat to raise and lower ~3" to accommodate different operator seat height preferences.

### Location

Helm Seat

### Operation

Lift the handle on the seat pedestal located on the outboard side of the pedestal (circled in red). To raise, lift handle and remove body weight and the seat will extend up. To lower, lift handle while applying weight to the seat to compress the gas assisted mechanism inside. Release handle between the topmost and lowest position to set and hold the seat height.

### Troubleshooting

If the gas assisted seat lift will not operate properly, take the boat to an authorized MasterCraft dealer for repair.

# CONVERTIBLE CENTER REAR SEAT



## Models

Optional on all NXT, X, XT, and XStar models.

## Purpose

The convertible center rear seat gives occupants the option to sit forward-facing, sit rear-facing, or create a center cockpit sunpad.

## Location

Aft section of the cockpit.

## Operation

The seat has a sliding/locking pivot connecting the seat back to the seat cushion.

*Forward to rear-facing and vice versa:* Lift sharply up on the handle at the top of the seat back to lift off the “Lock” position. Hold the

handle while lifting the seat back up and away from its current position. The seat cushion will then lift and rotate. Continue pulling forward until the seat cushion rotates past vertical. Then lower the handle and press the seat back down toward the cockpit floor as the seat cushion comes to rest 180 degrees from its previous position. This will reengage the lock.

*Rear-facing to sunpad:* When the seat is in the rear facing position, lift sharply up on the handle at the top of the seat back to lift off the “Lock” position. Hold the handle while rotating the seat back toward the bow of the boat. The seat back will rotate and lay down on braces in the cockpit to create a full sunpad.

*Sunpad to rear-facing:* Lift and rotate the handle on the seat back. When the seat back is vertical, press the seat back down toward the cockpit floor as the seat cushion comes to rest 180 degrees from its previous position. This will reengage the lock.

# REMOVABLE REAR SEATS



## Models

ProStar, as an option

## Purpose

Two removable rear seats allow additional passengers to be transported in the boat. The seats can be removed when not needed.

## Location

Aft section of the cockpit, port and starboard.

## Operation

*Removal:* Lift the forward edge of the seat bottom. Rotate up and pull forward at the same time. Two hooks on the seat back will release from eyelets connected to the rear deck wall. When released, lift seats out of the boat and store.

*Installation:* Set the seat on the cockpit floor near the aft cockpit wall. Lift the forward edge of the seat bottom. Slide the seat rearward until the seat back hooks touch the aft cockpit wall just below the eyelets. Set the seat bottom down slowly, ensuring that both seat back hooks pass through an eyelet.



**Never operate the boat without the rear seats installed properly. Seat back hooks firmly captured by the eyelets and all four foot pads sitting on the cockpit floor.**

# BIMINI SURF SLEEVES



## Models

Optional on all boats equipped with a bimini.

## Purpose

Surf sleeves allow the operator to stow surf boards during boat operation without taking up additional space on deck. This is useful for surf boards which may not fit in storage compartments.

## Location

Surf sleeves are mounted on top of Bimini canvas.

## Operation

Slide surf boards inside one of the four pockets and snap the protective strap to secure each board. Always secure the surf boards



with the straps and be sure that the boards are fully inserted into the sleeves, as boards can become dislodged and fall onto the deck, potentially harming passengers. Never trailer a boat with surf boards in the surf sleeves, even if the straps are snapped. The force on the system could cause the straps to break and allow the boards to come out of the sleeves.



**Never tow over the road with anything in the surf sleeve, even with the straps connected. Wind and air currents can be sufficient to break straps and/or force the surf boards or other items to dislodge. This could result in damage to vehicles following and/or serious injury or death to individuals in those vehicles.**

## BIMINI SURF STRAPS

### Models

Bimini surf straps are an optional feature for the NXT, XT, X, and X Star models. They can be combined with the surf sleeves to provide up to 4 additional board storage locations.

### Purpose

Surf straps allow passengers to easily stow their surfboards in a shaded location. By buckling their surfboards to the underside of

the bimini canvas top, passengers keep the deck free of excessive clutter. Additionally, the shade cast by the canvas helps protect the boards from delamination caused by sun damage.

### Location

The surf straps are located on the underside of the bimini canvas top. There are 4 surf straps in total, holding a maximum of 2 boards at a time. Each pair of straps has a fore and aft lock.

### Operation

The surf straps buckle and tighten using a set of slip lock straps. To stow a surfboard, identify which pair of straps you wish to use, then buckle the 2 slip locks and leave loose. Insert the board and tighten as needed until it fits snugly against the canvas underside.

As an alternative method of operation, you may stow the board by buckling just one of the slip locks, inserting the board, and then buckling the second slip lock and tightening as needed.



**When stowing a board, make sure the board is properly secured. An unsecured board may lead to property damage or personal injury. *Always* ensure the slip locks are adequately tightened.**

**PREPARATION**



**PREPARATION**

# USING CARE WHEN FUELING

MasterCraft boats are equipped with a highly innovative fuel system. This system is designed to provide years of trouble-free service. The MasterCraft fuel delivery system is based on the latest innovations in fuel handling and safety.

The fuel pump system in MasterCraft boats is specifically designed for the marine environment and contains a number of added safety components. Because of the special nature of the design, there are no user-serviceable parts. Any parts in need of service or maintenance will need to be addressed by an authorized MasterCraft dealer. An authorized MasterCraft dealer is equipped with the special tools necessary to disassemble and service the fuel capsule and associated parts. Replacement parts must meet OEM requirements as specified by MasterCraft.

The fuel line in the bilge area that goes from the tank to the engine is a special multi-layer armored line covered with a special material known as a fire sleeve. The fire sleeve protects the fuel line in the unlikely event of a boat fire. The sleeve is orange colored so that the fuel line can be easily identified.

Filling the fuel tank for the first time will take much longer than subsequent fillings as air is being displaced in the system. For all subsequent fuel-fillings, the process will take about the same amount of time as it does to fill a land-based vehicle.

During refueling you should reasonably expect to avoid having

any fuel spit-back or well-back when using an automatic shut-off fuel pump nozzle. All land-based gas stations in North America are required to use these; some marinas may not. Therefore, we recommend that you never leave the fuel fill unattended when fueling.

MasterCraft recommends daily inspection of the bilge for foreign materials including possible gas or oil leakage. As part of your daily inspection, include a visual check of the orange fire-sleeved fuel line. If you see damage to the sleeve or line or in any way suspect damage or fuel leakage, DO NOT START THE BOAT! Immediately call an authorized MasterCraft servicing dealer and let him or her assess the situation. Leaking fuel can cause serious damage to the environment and may be a potentially hazardous situation for people and property in the area. Therefore, it is critical to attend to any indication that there is fuel line damage or fuel leakage as soon as possible.



**Gasoline is extremely flammable and highly explosive under certain conditions. Always stop the engine and never smoke or allow open flames or sparks within fifty (50) feet of the fueling area when fueling.**



## DANGER

Take care not to spill gasoline. If gasoline is spilled accidentally, wipe up all traces of it with dry rags immediately and dispose properly on shore.



## DANGER

Gasoline is explosive. If a gasoline odor is present or gasoline is visually observed in the bilge area during inspection, **DO NOT START YOUR ENGINE!** If the engine is already running, press the **START-STOP** button to stop the engine. Remove the ignition key from the ignition switch and call an authorized MasterCraft dealer for service.

# FUEL LEVELS

Starting the engine with fuel levels below the acceptable standard will likely cause damage to the fuel pump. MasterCraft, working in conjunction with the fuel pump's manufacturer, has determined that on initial (first-time) use, the boat should have a minimum of fifteen (15) gallons of gas. This will prevent fuel starvation in instances of extreme running angles or when fuel sloshes away from the fuel pick-up.

Note that continuous wake surfing port or starboard with low fuel in the tank will starve the pump of fuel and cause it to either seize or overheat and blow fuses. The boat should never be used for wake surfing at less than one-quarter (1/4) tank full of fuel.

## CAUTION

Allowing the fuel level in the fuel tank to fall below one-quarter of a tank full may affect the reliability of the fuel pump or result in damage to the fuel pump, which is not covered under warranty.



# **ILMOR MARINE ENGINES**



# ILMOR OWNER'S MANUAL

MasterCraft boats are equipped with ILMOR Marine Engines, the finest quality power plant in the industry. ILMOR supplies an Owner's Manual with the purchase of your MasterCraft boat. For inquiries regarding ILMOR specific components contact :

## ILMOR MARINE, LLC (U.S.A.)

www.ilmor.com

186 Penske Way

Mooresville, NC 28115

844-GO-ILMOR (844-464-5667)

(704) 360-1901 FAX

service@ilmormarine.com

## GASOLINE

Additional, critical information regarding the proper use of gasoline in relation to the ILMOR Marine Engine is contained in the engine owner's manual, including but not limited to:

- What type of gasoline to use
- Avoiding oxygenated fuels or fuels with alcohol
- What to do when the boat is not used for long periods of time
- Fueling outside the United States and Canada.

## CAUTION

Damage to the engine by use of low-quality gasoline or gasoline with an octane rating below the minimum level listed for ILMOR MVB engines will void the warranty on the engine. Extended storage with fuel in the system can affect fuel stability and may require system inspection and fuel filter replacement when the boat returns to service.

## Troubleshooting the Fuel System

### Fuel Pump Does Not Run When The Engine Start-Stop Button Is Pressed

#### Cause 1

Pump may not be receiving sufficient voltage to the pump, or there may be corrosion interfering with the electrical impulse.

#### Remedy 1

Take the boat to an authorized MasterCraft dealer. Only the dealer has the specialized, required tools to correct the problem.

#### Cause 2

The fuel pump relay may have tripped.

#### Remedy 2

Reset the relay on the EPDM screen on the dash.

## **The Sound Of The Fuel Pump Running Is Audible But The Engine Does Not Start**

### **Cause**

The system may have inadequate fuel pressure or clogged fuel filter and/or lines.

### **Remedy**

Take the boat to an authorized MasterCraft dealer. There are a variety of potential causes that can negatively impact fuel pressure. All repairs require specialized tools available only to dealers.



# SAFETY CHECKS AND SERVICES

The following checks and services are essential to safe boating and must be performed. Get in the habit of performing these checks in the same order each outing so that it becomes routine.



## WARNING

**DO NOT launch or operate the boat if any problem is found during the Safety Check. A problem could lead to an accident during the outing, resulting in death or serious injury. Any and all problems should receive attention immediately. See your authorized MasterCraft dealer's service department for assistance.**

## Before Each Operation

**These tasks are best accomplished before the boat is launched.**

- Follow all engine and drive train pre-operation maintenance and safety checks as outlined in the provided engine owner's manual.
- Check the weather report, wind and water conditions.
- Check for recommended on-board tools and parts.
- Check that all drain plugs are installed properly, including bilge and rear drain.
- Check the propeller and shaft for damage.
- Check that there is an adequate supply of fuel.
- Check that the steering system operates properly.
- Check that required safety equipment is on board.

- Check that the windshield and extrusions do not show any damage.
- When boating, avoid using the windshield as an aid for balance or getting out of a seat. This causes undue stress to the window frame and could damage it, which may not be covered under warranty.
- Check that the fire extinguisher is fully charged.
- Check that no fuel, oil or water is leaking or has leaked into the bilge compartment.
- Check all hoses and connections for leakage or damage. Under normal operations, there will be some vibration, and this may loosen hardware over time.
- Check that everything is secure, tower and mirror knobs are tightened, all latches and brackets are secure, and anything that might move around in the cockpit during operation has been stowed. Even soft objects can cause injury when underway.
- Check that all required Scheduled Maintenance Checks and Services (see following sections) were performed.

## During Operation

- Check gauges frequently for operating conditions.
- Pay attention that controls operate smoothly.
- Note any excessive vibration.
- Check that everything is secure, tower and mirror knobs are tight-

ened, all latches and brackets are secure, and anything that might move around in the cockpit during operation has been stowed. Even soft objects can cause injury when underway. Check that all required Scheduled Maintenance Checks and Services (see following sections) were performed.

## **After Operation**

- Check for fluid leaks.
- In boats equipped with a ballast system, drain water from the ballast system before placing the boat on the trailer. Note that the engine must be running at least 1500 RPM during the pumping process (for both fill and empty operations). Drain water prior to ceasing operation of the boat and loading on the trailer. More information regarding ballast systems appears in various sections of this Owner's Manual, but pay particular attention to the information in the Boat Operation section of this Owner's Manual
- Check the fins (where equipped), propeller, rudder and shaft for damage after removing the boat from the water.



# NEW BOAT BREAK-IN

The first fifty (50) hours of operation are the most important for establishing acceptable wear parameters for the boat. Proper break-in will ensure maximum performance and the longest possible power-train life. The break-in period allows moving parts within the engine and transmission to wear-in properly. All MasterCraft boats are lake-tested on the water before leaving the factory, but the break-in must continue for the first fifty (50) hours of your ownership.



# NEW BOAT BREAK-IN

## CAUTION

To ensure proper break-in and lubrication, boat owners should not remove the factory break-in oil until after the initial ten (10) hours of operation and before twenty-five (25) hours. At that time, an oil change should be performed by an authorized Ilmor/MasterCraft dealer. Failure to follow the break-in procedure exactly as stated will void the engine warranty!

**NOTE:** Before operating the boat for the first time, you must read the engine manufacturer's manual completely in addition to this Owner's Manual!

Please follow the break-in procedure carefully. Close attention to the following is very important:

### Maintain the proper oil level

Until the piston rings, cylinder and other working internal parts are thoroughly seated, oil consumption can be high and must be carefully watched. (This continues to be important after break-in, as well).

### Pay close attention to the gauges and video screen(s)

It is important to stop the engine immediately if the gauges and/

or video screen(s) indicate a problem. Low oil pressure and overheating are serious issues and require immediate attention.

### Abnormal vibration or noises

These symptoms can be the first signs of trouble and should not be ignored. Occasionally, hardware may work loose, mountings may need to be tightened or the drive line may require attention.

### Fuel, oil or water leaks

Leaks can pose a serious safety threat. While all new MasterCraft boats are lake tested at the factory to check for leaks, it is still possible that one may occur. If a leak does occur, it is quite likely that it will happen during the first few hours of operation.

### Vary the engine speed

Never run the engine for more than three (3) minutes at any constant RPM during the break-in period. Following this specific instruction will assist in the proper break-in of rings and bearings.

### Plane the boat quickly

Operating the boat at low speeds places an excessive load on the engine. Plane quickly, then back down to a slower speed.

### First Hours of Operation

The first hours of operation affect the engine and drive train more

than any other component on the boat. Therefore, it is very important to follow the break-in procedure EXACTLY as outlined in the engine owner's manual.

Engine manufacturers have detailed and specific requirements for proper engine break-in. That information is found in the engine manual supplied, and must be followed exactly as indicated. Failure to do so could cause engine damage and/or failure that is not covered under warranty.

## After Break-In

Once the break-in period is over, the boat may be operated continuously at any speed, but not beyond the maximum indicated in the engine owner's manual.

The engines are equipped with rev-limiters which will cause a fluttering when reached. If the boat has the correct propeller setup, operators should never reach the limiter, but if that happens, it is a signal that you should reduce the throttle and check with an authorized MasterCraft dealer to determine the cause. Always remember that during normal operation you should allow the engine to warm up gradually. Be sure the engine is warm before accelerating. Pay careful attention to the gauges and video screen(s). Also, check the oil level frequently during the first fifty (50) hours of operation since the piston rings and cylinders require that much time to seat properly.

See the Scheduled Maintenance Checks and Services section for more details.

## CAUTION

**Failure to follow the engine oil recommendations listed in the engine owner's manual can cause additional engine wear and increase the possibility of engine component failure. Damage to the engine due to incorrect oil usage can be costly to repair, and it is not covered by the warranty!**



MasterCraft

# STARTING AND BASIC OPERATIONS

NOTE: If you are operating this boat for the first time, you must follow the engine and drive train break-in procedures as described in the engine owner's manual. Failure to follow these procedures may result in serious damage and may void any warranties!

# STARTING

## Before Starting

Familiarize yourself with the controls and indicators used on this MasterCraft boat. Perform all Safety Checks and Services as described in that part of this section of the Owner's Manual. Also perform all Scheduled Maintenance Checks and Services as described in this Owner's Manual.

### Step 1

Lift the engine cover and inspect the bilge and engine compartment for any fluid/vapor leakage. MasterCraft recommends lifting the engine compartment cover for inspection before each use.

### Step 2

Check the hull drain plugs. Make sure they are installed and secure.

### Step 3

Operate the bilge blower for at least four (4) minutes. Leave the bilge blower ON through the starting process and until the boat is on plane.



**DANGER**

**To prevent a possible explosion, operate the blower for at least four (4) minutes before starting the engine and always when at idle**

or slow-running speed. Explosive gasoline and/or battery fumes may be present in the engine compartment. Failure to do so may result in serious injury or death!



**DANGER**

**Before starting the engine, open the engine compartment and check for gasoline fumes, fuel and oil leaks or the presence of fuel or oil in the bilge.**

**NOTE: Always start the engine with the control lever in the neutral position or with the shift disengaged. Your boat is equipped with a neutral- start safety switch that will not allow the engine to be started when in gear.**

## Starting the Engine

Attach the emergency engine safety switch tether (lanyard) to an article of your clothing and to the switch.

All models will have a removable ignition key. Its purpose is for safety and security. The key should be inserted prior to starting an outing, and removed at the conclusion. This is intended to prevent theft or unapproved use of the boat.

The process for starting the boat is:

- Insert the key and turn. This turns ON the electrical system and prompts the battery(ies) to provide power.
- Momentarily press the ENGINE START-STOP button.

**NOTE:** While the engine is warming up, check to see that all lights, video screens and gauges operate properly. Check that the steering system operates freely. There should be no apparent leaks under pressure.

# BASIC OPERATION

## Shifting Gears

When shifting gears, always move the control lever smoothly into gear. Do not hesitate. Slow gear engagement could damage the shifting mechanism in the transmission.

**NOTE:** When shifting from forward to reverse or reverse to forward, be sure to stop the control lever in the neutral position and allow the engine to fall between 600-800 RPM before completing the shift.

A one-hand, single-lever control operates as both a gear shifter and a throttle. The lever automatically locks in the neutral position (straight up and down) for safety. The lever can be moved from neutral only by raising the umbrella lifter under the ball knob. Shifting is accomplished by moving the lever forward or backward. Center (straight up) is neutral. Moving the lever forward engages the running gear; moving it back from center puts the drive train into reverse. **Never attempt to shift without the engine running!**

This causes excessive wear to the shifting mechanism and may negatively affect control of the boat.

During regular warm-up of the engine, it is possible to temporarily increase the engine RPMs without moving the boat. To accomplish this, push in the button located at the bottom of the shift/throttle lever with one hand and pull up the “umbrella” (umbrella lifter under the ball knob). Move the lever to desired position and then simultaneously release the button and umbrella. The engine will run with increased RPMs and can be increased or decreased by moving the lever. Returning the handle to the neutral position will bring the system back to neutral and reduce the engine RPMs to preset levels. This function should be done sparingly. Over-revving the engine for any extended period can cause undue wear and tear on the engine. Avoid advancing to wide-open-throttle and holding the RPMs at that level.

## Under Way

If the oil pressure gauge indicates low or no oil pressure, immediately stop the boat as outlined below and check the oil level. If the temperature gauge indicates overheating, stop the boat when it is safe to do so as outlined below and check the raw water system for blockage. (See the Boat Operations and Care and Maintenance sections of this Owner’s Manual for directions on how to properly check for the blockage.) **DO NOT** operate the boat until the cause for the warning has been found and corrected.

## CAUTION

Continued operation after the warning light has illuminated may cause severe engine damage. This will void your warranty.

### Stopping

- Step 1: Slowly bring the control lever to the neutral position. If the boat has been driven for a long period of time or at high speed, allow the engine a two-to-three (2-3) minute cool-down period at low idle (600-800 RPM).
- Step 2: Press the ENGINE START-STOP button.
- Step 3: At the conclusion of the outing, turn the key off and remove from the key slot. Turn the battery switch to “Off”. Doing so will ensure that you have turned OFF the electrical system, and prevent others from starting or running the boat.
- Step 4: If any problems were encountered during operation, have the boat inspected by an authorized MasterCraft dealer. Request any necessary repairs before resuming operation of the boat.

# OPERATIONAL HINTS

MasterCraft urges all who will be operating the boat to seek certified instruction from the local boating authorities. This section is designed to present the most basic operational principles. It is NOT intended to cover all conditions encountered during operation. Therefore, the principles presented in this Owner's Manual are limited to the facts related directly to the operation of the boat, while the responsibility for the proper application of these principles belongs with the boat owner and/or operator.



## Loading the Boat

Never overload the boat. The maximum weight capacity as listed on the certification plate includes all items added to the boat (including persons and gear). Proper distribution of weight is critical to boat performance. Allocate the load as evenly as possible. The maximum weight capacity includes filled, factory installed ballast tanks and/or ballast bags, as well as any added by the customer.

The maximum weight capacity is calculated with full factory-installed fuel and ballast tanks. The weight of occupants, gear and water in any ballast bags added by the customer reduces the Maximum Capacity of the boat. Failure to adhere to the total Maximum Capacity may result in too much strain on the drive train or may sink the boat. This is not covered under warranty. See the Common Sense Approach information in the Safety section of this Owner's Manual regarding weight.

### **WARNING**

Adding supplementary aftermarket ballast to a MasterCraft boat is not recommended, and can result in impaired visibility, diminished handling characteristics and instability when operating your boat. Such condition may result in potential structural and/or engine damage to the boat. Such damage is not covered under warranty.

### **DANGER**

Information regarding the Maximum Capacity for each boat is included in the Guide to Individual Models section of this Owner's Manual and on a placard located near the operator's position. It is the boat operator's responsibility to ensure that the boat is never overloaded. Too much additional weight may cause the boat to overturn or sink, which can result in serious bodily injury or death.

## Emergencies

Know how to use and spot distress signals, and to offer assistance if possible. Remember, you may need assistance someday. Review the Safety section of this Owner's Manual.

## Courtesy

Always respect the rights of others on the water. Keep wide when passing, slow down in crowded areas, be alert and be aware of your wake and wash. See the Rules of the Open Water information in the Safety section of this Owner's Manual.

## First Time Operation

When taking to the water for the first time, you must keep in mind a few general guidelines:

Practice makes perfect! Start in calm water with no wind or current and plenty of room until you get the feel for the boat and its controls.

Proceed slowly! Give yourself time to think, react and maneuver.

Recognize outside forces! Check the wind direction and velocity, as well as water currents and waves.

Have a crew on hand! Have friends or family ready with fenders, lines and a boat hook to assist you when docking, as well as launching and loading.

Remember that a boat is not an automobile! Boats cannot be maneuvered and stopped like a car. Boats steer from the stern (rear) and have no brakes.

## **Basic Maneuvering**

Steering response is dependent upon three (3) factors: rudder position, motion and throttle. While cruising speed maneuvering is relatively easy and takes little practice, slow-speed maneuvering is far more difficult and requires time and practice to master.

With both steering and propulsion at the rear of the boat, the initiation of a turn pushes the stern of the boat away from the direction of the turn. The stern follows a larger turning circle than the bow. This is especially important to remember when making maneuvers within close quarters.

While the effects of unequal propeller thrust (torque steering), wind, and current may not always be present, a practiced driver will use them to his/her advantage.

Unequal thrust is a phenomenon shared by all single-engine, propeller-driven boats. With the rudder in the straight-ahead position, a counterclockwise rotation propeller tends to cause the boat to drive to port when going forward, and to starboard when going backward.

At high speed, there is compensation for this effect, so that unequal thrust is virtually non-existent. But, at slow speed—and especially during backing—the effect can be very pronounced. This is the main reason that most experienced drivers approach with the dock to the starboard side of the boat.

Stopping—or checking headway—is a technique that must be mastered. With no brakes, reverse must be used to stop the boat. The momentum of the boat will vary according to the load. Make it a practice to slow to no-wake speed before shifting into reverse.

When practicing maneuvering techniques, always do so in open water that is free of traffic. Adequate practice may make the difference between a pleasurable boating experience or a potentially damaging (at the very least, embarrassing) one.

## **High Speed Operation**

MasterCraft boats are designed to accommodate professional drivers with advanced operating skills who can perform high-speed maneuvers and turns on-a-dime. DO NOT attempt to duplicate or simulate these feats. Paid, professional drivers log thousands of hours on the water and carefully choreograph every move. Plans are made in advance in the event the routine must be aborted.

Maneuvers of this nature could cause serious injury or death, as well as damage to your MasterCraft boat that will not be covered under warranty.

**DANGER**

**Boat operators should never attempt to duplicate operational skills of professional drivers. When such maneuvers fail, it can result in serious injury or death.**

For the best engine performance and longevity, the wide-open-throttle (WOT) engine operation must be near the top of, but within, the specified WOT operating range. To adjust the WOT operating range, select a propeller with the proper diameter and pitch. The propeller supplied on the boat was chosen for best all-around performance under average operating conditions.

Load, weather, altitude and boat condition all affect WOT engine operation. If the boat is used for several different applications such as wakeboarding, barefooting and cruising, it may be necessary to have two (2) or more propellers of differing size and pitch to allow the engine to operate in the WOT range for each application.

Propping the boat should be done after the boat is loaded in the manner in which it would normally be loaded for each application. For example, in propping the boat for wakeboarding, fill the ballast tanks and add the people and gear that normally would be expected

in the boat. Take the boat out and after warm-up, run it at wide-open-throttle and note the maximum RPM. EFI engines are equipped with RPM limiters to prevent over-revving. Take note if the RPM limiter is activated.

If the WOT RPM is higher than the maximum RPM in your engine's WOT operating range, the boat is under-propped. Installing a higher-pitched propeller will reduce the WOT RPMs. An engine that is over-revving may quickly experience catastrophic damage, which will not be covered under warranty.

If the WOT RPM is lower than the minimum RPM in your engine's WOT operating range, the boat is over-propped. Installing a lower-pitched propeller will increase WOT RPMs.

An engine that is under-revving is "lugging." This places a tremendous load on the pistons, crankshaft and bearings and can cause detonation, piston seizure and other engine damage, which will not be covered under warranty.

**CAUTION**

**Engines should always be operated within engine manufacturer guide lines. Failure to do so may cause significant damage to the engine and drive train and is not covered under warranty!**

Elevation and weather also have a very noticeable effect on the wide open throttle power of an engine. Since oxygen gets thinner as elevation increases, the engine begins to starve for air.

Humidity, barometric pressure and temperature have a noticeable effect on the density of air since heat and humidity thin the air.

This phenomenon can become particularly apparent when an engine is propped for use on a cool, dry day in spring and then is operated on a hot, humid day in summer, and does not have the same performance. Although some performance can be regained by dropping to a lower-pitch propeller, the basic condition still exists. The propeller is too large in diameter for the reduced power output. An experienced marine dealer can determine how much diameter to remove from a lower-pitch propeller for specific high-elevation locations.

MasterCraft's engine manufacturer suggests that consumers consult with the dealer from whom the boat was purchased regarding the best propeller for the application in which the boat will primarily be run. However, be aware that changing the propeller may void the warranty. Again, working with an authorized MasterCraft dealer is your best bet to ensure excellent performance.

## Unusual Operating Conditions

If the body of water is unknown, talk to local boaters about the type of obstacles that may be encountered beneath the water's surface. Rocks, tree stumps and sandbars are all dangerous and damaging. Be especially wary of rivers and man-made lakes. Rapidly changing conditions can cause daily changes in underwater hazards.

Stay well clear of floating debris. What looks to be a small branch in the water may well turn out to be an entire tree.

When traveling through weedy areas, keep an eye on the engine temperature gauge. Weeds caught up and blocking the water flow through the raw water intake or transmission cooler will cause trouble. Also, after leaving the weedy area, shift to neutral for a few seconds and then to reverse for a few seconds to unwind any weeds that may have wrapped around the propeller.

## Docking and Tie-Up

Approach the dock slowly, with the starboard side of the boat if possible. The natural tendency of traditional inboards is to torque steer with the rotation of the propeller at slow speeds to make docking easier on the starboard side. On MasterCraft models equipped with the DockStar rudder system the boat will dock well to either the port or starboard side.

Before tying up the boat, be sure to use enough dock bumpers to protect the boat from damage. If possible, tie-up with the bow toward the waves. Use good quality double-braided nylon line. Tie-up only to the cleats or tie-down eyes. Never use the handrails or ski pylon.

### CAUTION

**Boats left at docks or at anchor must be monitored on a regular basis to avoid sinking. Maintain adequate battery charge to keep the bilge pumps operational to avoid excess water intrusion. If leaking is detected, immediately remove the boat from the water and determine the cause.**

If the boat is to be moored for a long period of time, use chafing protectors to protect the gel coat finish. Leave a little slack in the lines, allowing for some wave movement or tidal action where applicable. If the boat is to be kept in or near water for the season, consider the purchase of a boat lift and bottom paint for the hull. These lifts prevent the build-up of marine growth on the hull as well as protecting the boat from damage typical of on-water storage, such as blistering. Make sure the boat lift supports the hull correctly. See the next section, Lifting the Boat information in the Care and Maintenance section of the Owner's Manual.

# CARE AND MAINTENANCE



# LIFTING THE BOAT

When the boat is hoisted from the water, proper use of the stern eyes or a sling system is required for all MasterCraft models. Though stern eyes are designed to lift a boat from the water, care must be taken to ensure you do not damage your boat. A spreader bar used at the stern, will help ensure that the load at the stern eyes is vertical. A strap placed between stern eyes, and then lifted from the mid-point, is not the recommended method, and will put substantial additional stress on the stern eye mounting location.



## CAUTION

**DO NOT** use the ski pylon or any portion of any tower for lifting. They are **NOT** designed to be used as a central lifting point. Also, **DO NOT** use the stern ski tow as a lifting ring. The deck may be damaged. Never use the cleats as lifting points. See the Storage Cradle sub-section of this section. Also never lift a boat with water in the bilge or containing a water-filled device such as a ballast system or sack. The extra stress will put an excessive load on the hull and lifting equipment that may seriously damage the boat. Such damage may not be covered by the warranty.

## USING LIFTING EYES

An overhead hoist with an appropriate rating capacity should be used to lift your boat. Cables should be properly rated for each model. Each cable should be rated above the full weight of the model to be lifted. When lifting, keep the bow slightly higher than the stern to prevent any possibility of water running into the engine exhaust manifold.

## USING LIFTING SLINGS

An overhead hoist with an appropriate rating capacity should be used. Slings must be six (6) inches wide by twenty (20) feet

long and each sling should have a minimum capacity rating more than the weight of the model that is to be lifted. Use an eight-foot spreader bar on each sling to prevent damaging side pressure to the deck or gunwale molding.

## CAUTION

Lifting slings must never contact shafts, struts or hardware protruding from the hull. Damage may result that will void the warranty.

## CAUTION

When the boat is out of the water, it is important to support the hull correctly to avoid any hull damage. Such damage may void the warranty.

# STORAGE CRADLE

If a storage cradle is used, the hull must be properly supported to prevent load damage. This can occur with as little as fifteen (15) pounds per square inch of pressure. **DO NOT** support the boat by resting the hull on the keel (the central fore-and-aft structural member in the bottom of the boat's hull, extending from the bow to the stern). Vertical supports must extend from the chine (the angular intersection of the bottom and sides of the boat) to the keel with no gaps between the hull and cradle supports. A total support area of at least 500 square inches is required for proper support of boats under 25' and 600 square inches for boats over 25'. Protect all items extending from the hull (i.e., the rudder, propeller, fins, etc.) to prevent them from resting on the cradle or the ground. **DO NOT** apply any load stress to the propeller, shaft, rudder, swim platform, water intake grate or other protruding items.



MasterCraft X-Lite 8

# **CORROSION PREVENTION**

# GALVANIC CORROSION



**NOTE: DAMAGE DUE TO CORROSION IS NOT COVERED UNDER WARRANTY!**

Galvanic corrosion (electrolysis) is the decomposition of metal due to the effects of electrolytic action. When two (2) dissimilar metals are immersed in a conductive fluid (e.g., salt water), an electric current is produced, much like the action of a battery. As the current flows, it takes with it tiny bits of the softer metal. If left unchecked, severe damage may occur over time. If the boat is operated in salt, polluted or brackish waters, even temporarily, the boat should be equipped with a transom-mounted aluminum anodes to prevent damage to those metal parts coming in contact with salt water.

The aluminum is, by design, self-sacrificing. It is slowly eroded away by electrolytic action and requires periodic inspection for deterioration.

When the aluminum has eroded to approximately one-half (1/2) of its original size, it must be replaced to continue protection, or damage to other metal parts may result.

MasterCraft boats optioned with a saltwater package come equipped with aluminum anodes. For fresh water boats that may be temporarily operated in polluted or brackish water, an authorized MasterCraft dealer can assist in installing proper corrosion protection systems including sacrificial anodes and fresh water flush kits.

**DAMAGE DUE TO CORROSION IS NOT COVERED UNDER WARRANTY!**

# SALT WATER CORROSION

MasterCraft boats have been designed for operation in fresh water unless equipped with the Salt Water Package. If operating a fresh-water model temporarily in salt, polluted or brackish water, thoroughly flush the boat with fresh water as soon as possible afterward. The entire engine cooling system should be flushed with fresh water for at least ten (10) minutes after each use in such waters. Do not operate boats continuously in saltwater unless equipped with a closed cooling system to preserve engine life.

# SALTWATER CARE & MAINTENANCE

Saltwater or brackish water can deteriorate the condition of a boat much faster than freshwater. To maintain the condition, appearance and functionality of boats used in salt water:

1. Flush the engine with fresh water in accordance with the Ilmor Engine Owner's Manual (10 minutes minimum).
2. Rinse the boat with fresh water after each use in salt water:
  - Bilge
  - Hull and deck including all underwater gear
  - Upholstery
  - Carpet
    - If a boat has removable floor covering it should be removed for drying
3. Rinse metal components with fresh water and wipe down with WD-40:
  - Aluminum dash plates
  - Steering wheel
  - Tower components
  - Engine

- Hand rails
  - Cleats
  - Glovebox
  - Walk-thru door
  - Exposed Seat frames
  - Windshield frame and stanchions
4. Spray motor mounts with a corrosion inhibitor at least once a month.
  5. Inspect anodes and replace when they reduce to 50 percent of their original size.

## STAINLESS STEEL AND CHROME/ ANODIZED ALUMINUM

Stainless steel, chrome-plated and anodized aluminum parts are not totally resistant to corrosion. Occasional cleaning and polishing with a marine chrome-and-stainless polish will maintain and extend the life of these parts. In salt water areas, it is imperative that you thoroughly rinse all hardware with fresh water and apply a light coating of protective oil to enhance the appearance after each use. Exposure to salt water will cause corrosion leading to significant damage to stainless steel, chrome and anodized aluminum parts. Failure to thoroughly rinse salt water from all hardware, and to apply

protective oil after each exposure to salt water, will accelerate the corrosion of hardware and will void your warranty.

## MARINE GROWTH

If accelerated marine growth is a problem in the area in which the boat will generally be operated, an anti-fouling bottom paint may be necessary to slow growth while protecting the gel coat. Before selecting a bottom paint, talk with other boaters and an authorized MasterCraft dealer's service department to determine the product that works best in the area. Many local variables may also affect the selection of paint. Be sure to follow the paint manufacturer's directions exactly.



### CAUTION

Be sure all fasteners used are approved and rated for marine use. Most fasteners used on MasterCraft boats are stainless steel or specially coated to resist corrosion.

### WARNING

Use of improper parts may cause component or engine failure. Such failure may result in death or serious injury!

### CAUTION

Exposure to salt water will cause corrosion leading to significant damage to stainless steel, chrome and anodized aluminum parts. Failure to thoroughly rinse salt water from all hardware, and to apply protective oil after each exposure to salt water, will accelerate the corrosion of hardware and will void your warranty.

# CLEANING THE BOAT



Periodic cleaning is the best way to keep your boat looking like new. Regular washing and waxing keep dirt and build-up from deteriorating the finish. If you keep your boat in showroom-new condition, then your personal satisfaction will be higher and the resale value of your boat will be greater.

The boat is made of fiberglass-reinforced plastic resin material that is easy to clean and care for. Several layers of resin material are chemically bonded together to form the hull. The smooth outside surface of the hull is a layer of gel coat resin. The gel coat is a solid color that is only a few millimeters thick.

Beneath the gel coat surface is a series of layers of chemical resin, fiberglass mat and woven roving. It is these layers that give the boat its strength and maintain the hull shape. The boat bottom also uses special coremat material for its strength-to-weight and superior marine performance.

Even though MasterCraft has carefully crafted boats from resilient materials, it is still the responsibility of the boat owner to perform regular and routine cleaning maintenance to ensure that the boat exterior, interior and components retain both their appearance and strength.

## HULL



When washing the boat, use a mild detergent, such as Dawn or Ivory dish soap, or similar commercially-produced detergent, and warm water solution. DO NOT use abrasive cleaners, solvents, ammonia or chlorine, as these will damage the gel coat surface.

Under extreme conditions, special cleaners may be used to remove marine growth from the hull. (See an authorized MasterCraft service department for further instructions.)

# CARPET



Occasionally washing with mild detergent and warm water or household carpet cleaners will help keep the carpet clean. Thoroughly hose the detergent out of the carpet and into the bilge. (This is a good time to clean the bilge also.) Allow the boat to remain uncovered to air dry for several days to prevent any mildew or odor caused by moisture.

# PLATFORMS

## All Wood Platforms

If shoes are worn when walking on the wood, they should be proper boating shoes. Black-soled shoes are likely to scuff the surface, resulting in marks that may be difficult to remove or even leave

permanent marks that are not covered under warranty. Regular cleaning and oiling of wood will maintain its original appearance. Unprotected wood will turn gray and could split or separate. If this happens it may void the warranty.

New wood platforms have been sealed and finished with an oil-based, wood preservative by the manufacturer.



Platforms will keep the new look and last for many, many years if properly maintained. For best results re-oil the platform and allow it to dry before the first use. If the boat spends a lot of long weekends on the lake with the swim platform in the water or if the platform sits uncovered in the sun, it should be oiled one or two times a month during the first season; then as needed after that. The platform should be covered when not in use or when stored for the winter.

Many products such as boiled linseed oil, tongue oil, wood oil and other outdoor wood preservatives can be found at marinas, paint stores or home improvement stores. Some oils such as linseed oil

should be thinned with a thinner like mineral spirits before use. (70 percent oil-30 percent thinner.)

When oiling a platform, apply a coat of oil with a wet cloth, work into the seams, end grain and edges. Allow the oil to set approximately 15 minutes and then wipe off the excess oil with a dry cloth. Do not let the oil dry on the platform in the sun. Excess oil should be removed with a dry cloth.

## SeaDek Platforms



SeaDek should be handled only with clean hands. Oil, grease or dirt may leave permanent imprints on the surface. Whenever possible, keep the platform covered when the boat is not in use. It should be stored dry. Refer to the SeaDek Pads section later in this chapter for instructions on how to clean your SeaDek Platforms.

## Fiberglass Swim Platform

The fiberglass swim platform requires the same kind of regular—and gentle—cleaning that the rest of the boat needs. After cleaning off any environmental debris, wash with mild soap and warm water. Avoid the use of ArmorAll or similar types of rubber-shine products as these will speed the decay of the rubber rather than protect it.

## WINDSHIELD



In cleaning tempered glass windshields, the normal glass cleaners (from spray bottles or aerosol cans) work best. While the glass is very strong, it can be scratched if anything abrasive is used. Harsh chemicals or solvents should be avoided because they may affect the vinyl gaskets, anodized or powder-coated finish on the extrusions.

# CANVAS COVERS



The material used in constructing bimini tops and boat covers is made from 100 percent solution-dyed polyester fiber with a urethane coating to provide excellent water repellency and mildew resistance. This design allows the material to be easily maintained. By following a few simple care and cleaning steps, the fabric will continue to look good and maintain its fine qualities for seasons to come.

## Important Background Information

Because the fabrics are woven, they are breathable. It's also important to know that these fabrics are treated with a fluorocarbon finish, which enhances water repellency. This finish requires replenishment after vigorous cleaning. Polyester fabric will not support the growth of mildew. Mold and mildew need something on which

to grow and polyester fabric is not a desirable substance for such growth. Dirt or dust on the fabric, however, is a perfect source for mildew growth, which makes regular cleaning of the fabric important.

The material has an applied finish that deters mold and mildew growth, but it does not make it mold-proof. Keeping the fabric free of dirt and foreign substances is important in deterring mold growth.

There is no set time for when the fabric should be cleaned, and the local environment has a great deal to do with determining cleaning frequency. Cleaning is required less frequently in a dry environment than in a humid one where heavy foliage exists.

## Cleaning

One of the best ways to keep the material looking fresh and new, and to delay the need for deep or vigorous cleaning, is to hose off fabrics with clear water on at least a monthly basis. This practice will help prevent dirt from becoming deeply embedded in the fabric, and it will eliminate the need for more frequent and more vigorous cleanings.

In most environments, a thorough cleaning will be needed approximately every two (2) years.

The fabric can be cleaned while still in the boat. When cleaning, it is important to observe the following:

- Always use a natural soap—never detergent.

- Water should be cold to lukewarm, but never more than 100 degrees.
- Air dry only. Never apply heat to the fabric.
- Begin by brushing off loose dirt, and then hose down the material.

Prepare a cleaning mixture of water and a mild, natural soap that is free of detergents. Use a soft-bristle brush to clean, allowing the soap to soak in. Rinse thoroughly and allow the fabric to thoroughly air dry.

If stubborn stains persist, you can use a diluted chlorine bleach/ soap mixture for spot cleaning of mildew, roof run-off and other similar stains. Please keep in mind that chlorine bleach will not change the color of the fabric, but chlorine bleach will eventually break down the fiber of any fabric. Therefore, this cleaning method should be used as infrequently as possible.

### **The cleaning mixture should be mixed as follows:**

- Four ounces (one- half cup) of chlorine bleach.
- One gallon of water.

Clean with a soft- bristle brush and allow the mixture to soak no longer than twenty (20) minutes. Rinse thoroughly and allow to completely air dry. Repeat if necessary.

## **Machine Washing Canvas Covers**

Machine washing is not recommended, however if the canvas fits in the washing machine MasterCraft recommends:

- Use only natural soaps—no detergent.
- Wash and rinse in cold water. Air dry. (Never put the fabric in a dryer.)

As part of the finishing process, the material has been treated with a fluorocarbon finish, which enhances water repellency.

This finish is designed to last for several years, but it must be replenished after a thorough cleaning. Based on test results, the manufacturer recommends 303 High Tech Fabric Guard™ as the preferred re-treatment product.

After cleaning and air drying, apply 303 in a thin, even coat. When it has dried, apply a second thin, even coat. These two (2) light coatings are more effective in restoring fabric water resistance than a single heavy coating. Keep in mind that 303 High Tech Fabric Guard™ will work only as well as it is applied. This means that the fabric must be free of dirt and detergents or the Fabric Guard will wash away with the dirt particles.

Fabrics should be retreated after thorough cleaning or after five (5) years of use.

## ENCLOSED HEAD

An enclosed head is found on the X26 model. The head should be emptied on-shore within an acceptable holding tank, septic system or sewer. It should never be emptied within the boating body of water or on-shore, except in an approved receptacle.

The head should be cleaned after each outing. After thoroughly cleaning with a mild detergent, add a neutralizing chemical made especially for portable heads, such as that found in RV centers. The neutralizing chemical will help deal with potential odors that might otherwise be foul. (See also Head under the Boat Operations section of this Owner's Manual.)



## UPHOLSTERY

While the vinyl is made to withstand the elements, it is important to care for vinyl by keeping it clean at all times. Many substances may stain the vinyl if left untreated over a period of time. Remember to remove any contaminant and clean vinyl immediately.

Regular washing with mild detergent and warm water or vinyl cleaners is sufficient to keep the cushion and vinyl coverings in good condition.



Do not soak the cushion, and dry thoroughly after washing to prevent mildew accumulations when the boat is covered. Spray the cushions with a mildew repellent and prop them up in the boat when it is covered to take advantage of air circulation. MasterCraft vinyl is made to withstand the effects of sun, heat, acid rain and soiling, under normal conditions, but this does not preclude the cleaning requirements. Please consult the following cleaning recommendations before cleaning your upholstery.

In some instances, consumers have reported the appearance of a pink stain on vinyl that is resistant to various cleaning methods. Although there can be other causes for pink staining in vinyls, most pink stains are caused by dyes produced by micro-organisms. These dyes are metabolic products of the micro-organisms, otherwise known as a form of fungi.



It is virtually impossible for consumers to avoid these micro-organisms as they exist in the atmosphere, and are more prevalent in high-humidity areas. Rain cleanses the air, with the result being that the micro-organisms are deposited on items such as marine vinyl.

While the vinyl is treated to resist the growth of micro-organisms (meaning the vinyl is not a food source), the stain results from failure to properly clean and maintain the vinyl. This means that after use, the upholstery must be cleaned with a soft brush and warm soapy water, followed by a thorough rinse with clean water.

This situation is worsened if the boat is stored without proper ventilation or if the boat cover is put on while the vinyl is still wet, creating a situation in which all forms of fungi (mold and mildew) thrive. Failure to follow these instructions in the proper care of upholstery may cause your warranty to be voided!

The cleaning table presented in this section is offered only as a suggestion and as an aid in attempting to deal with stains. We do not guarantee that the cleaning methods will work. Stains from any external source are unlikely to be covered by warranty.

## Additional Upholstery Cleaning Information

The following information refers to the performance of the upholstery product in specific tests conducted under laboratory conditions. Results may vary under actual conditions. This information is not a guarantee and does not relieve the user from the responsibility of the proper and safe use of the product and all cleaning agents. The use of certain agents can be harmful to the surface appearance and lifespan of the vinyl. The vinyl manufacturer and MasterCraft assume no responsibility resulting from the use of such cleaning agents to the vinyl. Please check compatibility when using this product in combination with painted or varnished surfaces.

**\* Always remove stains immediately. Upholstery must be kept CLEAN AND DRY!**

Common Stains	Step 1	Step 2	Step 3
General Care		A	B
Dirt build-up	A	B	
Ballpoint ink*	B	A	
Chewing gum	B	A	
Coffee, tea, chocolate	B	A	
Grease	C	B	A
Household soil	A	B	
Ketchup	A	B	
Latex paint	A	B	
Lipstick	C	A	B
Mildew or wet leaves*	B	A	
Motor oil	C	B	A
Oil-based paint	C	B	A
Permanent marker*	B	A	
Spray paint	B	A	
Suntan lotion*	A	B	
Tar/asphalt	C	B	A
Yellow mustard	A	B	

A = Medium soft brush, with warm soapy water. Rinse and dry.

B = 303 Fabric and Vinyl Cleaner. Rinse and dry.

C = Wipe or scrape off excess (chill gum with ice before starting).

All cleaning methods must be followed by a thorough rinse with clean, warm water. Failure to care for your vinyl properly, or the use of improper cleaners, may void your warranty, as well as damage your vinyl.

Certain household cleaners, powdered abrasives, steel wool, and solvent cleaners can cause damage and discoloration and are not recommended. Dry cleaning fluids and lacquer solvents should not be used because they will remove printed pattern and gloss. Waxes should be used with caution because many contain dyes or solvents that can permanently damage the protective coating.

Do not clean with power washers as they can generate 3,500 P.S.I. and could damage the surface of your interior. Do not use kerosene, gasoline or acetone, because they will remove the protective marine top coat. Do not use any silicone based protectants. They will extract the plasticizer, leaving vinyl hard and brittle, and eventually cracking will occur.

Vinyl upholstery should be covered when not in use to protect from further sun exposure, tree debris, air pollutants and acid rain.

For storage, vinyl should be cleaned, protected, covered and stored in a dry, well ventilated area.

## Recommended Products

- MasterCraft Vinyl Dressing
- Vinyl Finish
- Vinyl Cleaner



- Mild Dish Soap
- 303 High Tech Fabric Guard™
- 303 Fabric and Vinyl Cleaner™
- Babe's Seat Soap

## Non-Recommended Products

- ArmorAll
- Bleach
- Baking Soda
- Fantastik
- Formula 409
- Murphy's Oil Soap
- Son-of-a-Gun
- Simple Green
- Anything not listed on the Recommended Products list

# SeaDek Pads

## Models

All X, XT, NXT, and Star Series models.

## Purpose

SeaDek provides an EVA foam-based alternative to carpet. SeaDek is installed using a stick-on adhesive and is not intended to be removable.

## Location

SeaDek pads adhere directly to the flooring, gunnels and other locations around the boat.

## Care

SeaDek Marine Products recommends using Dek Magic™ cleaner, which has been specifically developed for easy cleaning of PE/EVA nonskid materials and is effective on a variety of stains. Dek Magic is available for purchase on [seadek.com](http://seadek.com). For best results, wet with water then spray Dek Magic liberally over the entire area. With a medium bristled brush, lightly work the product in. Let the cleaner sit for 3-5 minutes then use water to dampen the area and lightly scrub again. Rinse the cleaner off thoroughly and dry with a clean towel. If you encounter a stubborn stain, repeat these steps as needed.

If Dek Magic is not available, see the below steps for other cleaning options.

## Dirt and Footprints

Use an all-purpose cleaner, degreaser, or dish soap along with warm water and a medium bristled brush. Thoroughly work the soapy mixture into the SeaDek until stain comes up. Rinse with clean water and repeat if necessary.

### **Suntan Lotion, Grease, and Oils**

Use an all-purpose cleaner or degreaser alone with a medium bristled brush. Put small amount of the cleaner on the oil stain and use a medium bristled brush and warm water to scrub until the oil is out. Rinse with clean water and repeat if needed.

### **Rust Stains**

Wet the affected area and apply a dry, powdered Oxalic acid (such as Barkeeper's Friend) to the rust stain. Use a medium bristled brush to work the powder into the stain and allow to soak for 3-5 minutes. Rinse with water and repeat if necessary. When applying oxalic acid, use care to avoid getting acid on the edges of the pad, as it could damage the lamination or PSA.

Please follow your state and/or country regulations for proper chemical handling.

Wear vinyl or nitrile gloves and eye protection when necessary.

### **USE WITH CARE**

- Although highly effective, using a pressure washer to clean SeaDek pads can cause damage if not done properly. DO NOT exceed 1200 PSI. Spray from the middle to the outside of the pads. Do not point the pressurized spray under the edge of the pad.
- Acetone (if it must be used, avoid the edges of the pad to protect the adhesive)
- Oxalic Acid (if it must be used, avoid the edges of the pad to protect the adhesive)
- Bleach (if used, dilute 1 cup with 1 gallon of water)

### **DO NOT USE**

- Citrus Cleaners
- Mineral Spirits

**For best cleaning results, tend to all stains, spills, and leaks as soon as possible.**

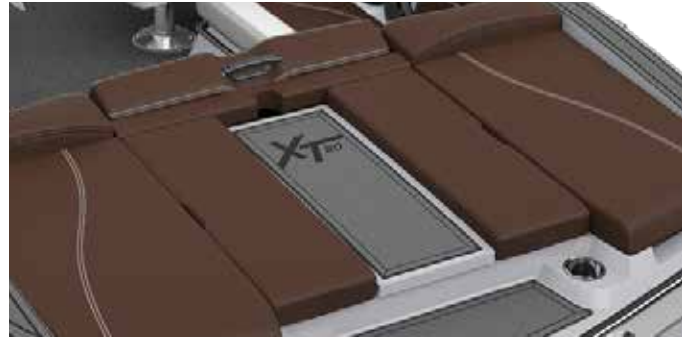



# **MAINTENANCE SERVICE**

# FREQUENCY AND SCHEDULED MAINTENANCE

Proper care, maintenance and adjustment will contribute to the peak performance of the MasterCraft boat, while also extending the overall service life and the resale value.

The pages that follow provide instructions on how to accomplish the required checks, inspections and services listed. An authorized MasterCraft service department is the best source for proper maintenance.

**NOTE: The engine and drive train require scheduled maintenance checks and services in addition to the boat's other maintenance requirements. Read and understand the engine owner's manual that has been provided, and follow the maintenance schedule to ensure proper operation and quality service over the life of the boat and drive train. Failure to follow the maintenance requirements and instructions listed in this and all other manuals may result in damage to the components, systems and equipment of the boat. Resulting damage will not be covered by warranty. Safety issues are also directly impacted by proper maintenance!**

## Maintenance Definitions

### Check

Verify the operational readiness by physical measurement, i.e.,

measuring the oil level with the dipstick or aligning with a feeler gauge.

### Inspect

Determine the operational readiness by examination, i.e., by sight, sound or feel.

### Change

Tasks required periodically to keep the boat in proper operating condition, i.e., drain, replenish or service.

## NEW BOAT BREAK-IN

**NOTE: MasterCraft recommends the following functions be performed by authorized MasterCraft technicians at an authorized MasterCraft dealer.**

- Check the alignment of the propeller shaft. (See Annual Maintenance also.)
- Have an authorized MasterCraft service department change the fuel filter after the first fifty (50) hours of operation, and then again at one hundred (100) hours. The fuel filter should be changed annually, even if less than one hundred (100) hours are run during the previous season.

# BEFORE EACH USE

## Before Starting the Engine

Review the engine manual before each outing to determine the drive train requirements that need to be followed prior to each use.

Review the Safety Checks and Services section of this Owner's Manual. There are important functions that must be followed before, during and after every outing:

- Inspect the raw water intake strainer for blockage. If there is blockage, also check the transmission cooler (where equipped).
- Check and clean the seacock strainer as necessary.
- Check the cooling system level. See the engine owner's manual for details.
- Inspect the battery connections and hold-downs.
- Inspect the drive train for loose or missing hardware.
- Inspect the throttle and shift cables for kinks, wear and interference with other components.
- Inspect the propeller shaft log for excessive water entry.
- Inspect the fuel system lines and connections for leaks.
- Check for water leaks or excessive exhaust odor.
- As you start the engine, check that the voltage reading registers a fully charged battery.

# AFTER EACH USE

Refer to the Cleaning the Boat and Corrosion Prevention sections of this Owner's Manual for guidance on a thorough approach to maintenance. Also pay attention to the information provided regarding the maintenance of teak platforms and accessories, because the wood requires periodic maintenance as well.

Boats equipped with an optional flushing system for use in salt water or brackish water should operate the flushing system.

## Quarterly (Every Fifty [50] Hours)

### Before Starting the Engine Or After It Has Cooled

- Check the safety equipment.
- Change the oil.

## Annually (Every One Hundred [100] Hours)

**NOTE: MasterCraft recommends that the following be performed by authorized MasterCraft technicians at an authorized MasterCraft dealer.**

### Before Starting the Engine Or After It Has Cooled

- Replace the fuel filter (to be performed by an authorized MasterCraft technician only).
- Check the propeller shaft coupler alignment.
- Lubricate the steering system.

- Lubricate the throttle and shift cables.
- Check the engine mounts.
- Inspect the complete fuel system for leakage.
- Check the fire extinguisher and suppression units on-board.
- Change impellers.

MasterCraft recommends using an authorized MasterCraft technicians at an authorized MasterCraft dealer for many of these tasks!

# SCHEDULED MAINTENANCE

## Before Each Use

### Prior to Starting the Engine

Review the Safety Checks and Services section of this Owner's Manual. There are important functions that must be followed before, during and after every outing. The Safety Checks and Services section notes that all drain plugs must be reinstalled prior to operating the boat. This is critical to prevent taking on water

## Inspect Seacock Strainer

Because a clogged seacock strainer puts undue strain on the engine(s), the strainer should be checked prior to starting the boat. The seacock strainer is standard on all boats.



### Step 1

Open the strainer housing mounted to the engine (see photo).

### Step 2

Remove the filter and inspect for debris. Manually clean the strainer.

### Step 3

Remove anything found inside the sea strainer.

### Step 4

Return the strainer to the housing and replace the lid. Tighten the lid in place.

## Inspect the Battery Connections and Hold-Downs

Because poor connections or hold-downs may result in erroneous voltmeter readings, MasterCraft recommends doing this before starting the boat.



### Step 1

Ensure the engine is OFF and the engine safety starting switch disconnected. Be certain that the throttle/shift control lever is in neutral. Locate the battery. Batteries are placed in a variety of locations, depending on the model. Check under the observer seat or behind the rear seat.

### Step 2

Check that the battery post connections are clean and tight. If not, loosen and remove the negative terminal connection first. Be careful not to touch the positive terminal with the wrench.

Loosen and remove the positive terminal connection. Remove battery hold-downs and remove the battery from the boat. Clean corrosion from the battery posts with a battery terminal cleaner. Clean the battery with a water-and-baking-soda solution. Use care to avoid allowing the solution to enter the battery vents. Rinse the battery with fresh water.

## **WARNING**

**Battery electrolyte fluid is dangerous. It contains sulfuric acid, which is poisonous, corrosive and caustic. If electrolyte fluid is spilled or placed on any part of the human body, immediately flush the area with large amounts of clean water and immediately seek medical attention.**

Use a battery terminal cleaning brush to remove corrosion from the inside of the battery terminals. Clean the terminals with a water-and-baking-soda solution and rinse with fresh water.

Check the battery box that normally holds the battery in place to determine whether there is evidence of battery fluid inside it. Battery fluids are corrosive and can cause permanent damage to the battery box. If fluid is evident, wash out the box with the water-and-baking-soda solution that is used to clean the terminals. Rinse with fresh water and dry with a cloth.

Reconnect the positive terminal first, then the negative. Tighten the terminals. Coat both terminals completely with a thin covering of marine dielectric grease. Be sure that the rubber boot covers the positive terminal completely.



**NOTE:** The boat's engine is designed to work with the standard electronics installed in the boat. Adding other electrical components or accessories can change the way the fuel injection controls the engine or the overall electrical system functions. Before adding electrical equipment, consult an authorized MasterCraft dealer's service department. Otherwise, the engine may not perform properly.

## CAUTION

Add-on equipment may adversely affect the alternator output or overload the electrical system. Such damage may not be covered by the warranty.

If a replacement battery is required, be certain to select a marine battery with at least eight-hundred (800) cold-cranking-amps at zero degrees (0°) Fahrenheit. Before disconnecting the battery, make sure the ignition key and all accessories are in the OFF position. Also remember to re-attach the cables in the proper order, with the positive cable connected to the positive [+] post and the negative cable connected to the negative [-] post.

## WARNING

When charging, batteries generate small amounts of dangerous hydrogen gas. This gas is highly explosive. Keep all sparks, flames and smoking well away from the area. Failure to follow instructions

when charging a battery may cause an electrical charge or even an explosion of the battery, which could result in death or serious injury.

MasterCraft recommends the use of an AMP spiral-cell battery, such as the Optima brand. These batteries exceed other batteries in holding and extending a charge.

# INSPECT THE THROTTLE AND SHIFT CABLES FOR KINKS, WEAR AND INTERFERENCE

## CAUTION

Some engine parts become very hot during operation. This inspection must be completed while the engine is cool to prevent burns to your skin. Perform this task before starting the boat.

### Step 1

Ensure the engine is OFF, the engine safety starting switch is disconnected and the throttle/shift control lever is in neutral.

### Step 2

Open the engine compartment and locate the throttle and shift cables. Follow each cable back under the floorboards and feel for

any kinks and wear on the outer jacket. Any sign of cable damage is cause for replacement. See your authorized MasterCraft dealer's service department if you notice any cable damage.

## INSPECT THE FUEL SYSTEM FOR LEAKS

This function should be performed prior to starting the engine; and then again after about three (3)-to-five (5) minutes to determine whether any leaks are apparent.

### Step 1

Ensure the engine is OFF, the engine safety starting switch is disconnected and the throttle/shift control lever is in neutral.



**DANGER**

Gasoline is highly flammable and its vapors may ignite, resulting in fire or explosion. Be sure to keep all sparks and flames away from the area while inspecting the boat's fuel system.

### Step 2

Open the engine compartment and visually check as much of the fuel system from the tank to the engine as you can see. On some models this will be a limited area. If the odor of gasoline is strong or if you see visual evidence of fuel outside the system, cease all operations and take the boat immediately to an authorized MasterCraft dealer's service department to determine the source of the leak. The leak must be repaired before the engine is restarted. Because the lines on late model MasterCraft boats are pressurized, they can be disconnected and/or removed ONLY by using specialized tools.



**WARNING**

The engine box serves as a machinery guard. The engine must be OFF whenever the box is open. Clothing or body parts can get caught in moving parts, causing death or serious injury. Keep away from moving parts!

Fuel leakage can lead to a build-up of potentially explosive fumes within the engine compartment. **DO NOT IGNORE OR OVERLOOK THIS INSPECTION AND REPAIR AS NECESSARY!**

# NOTE ANY EXHAUST ODORS

This function should be performed prior to starting the engine; and then again after about three (3)-to-five (5) minutes to determine whether any leaks are apparent.

## Step 1

First ensure that the engine is OFF and that the engine safety starting switch is disconnected. Be certain that the throttle/shift control lever is in neutral. The engine must be cool.

## Step 2

Open the engine compartment and note whether there is any unusual odor. In many instances, exhaust will have little or no odor, but in the event of a potentially significant exhaust leakage, it may be possible to smell a “rotten-egg” odor that signifies a probable issue that must be addressed.

## Step 3

If leakage is apparent, tighten the hose clamps, being careful to avoid crimping the hose. If the leakage is significant, or is occurring at a location other than the joints (such as a split in a hose), see your authorized MasterCraft dealer’s service department for parts and service.

**Exhaust fumes can cause illness or impairment, including carbon monoxide poisoning. Equally important to consider, leakage can lead to a build-up of potentially explosive fumes within the engine compartment.**

**DO NOT IGNORE OR OVERLOOK THIS INSPECTION! REPAIR AS NECESSARY!**

# BEFORE EACH USE

## After Starting the Engine

### Check That The Battery Is Fully Charged

As the boat is started, check all gauges (base X and XT series analog gauges, X, XT, Star and NXT Series video display), but pay particular attention to the voltage.

While starting the engine, check that the voltmeter reads between 12.4 and 14.5 volts. An erratic reading may be a sign of low voltage. The voltage reading is the best indication of the status of your battery, however it is not fool-proof. While the reading may indicate that the battery is producing current, if during a previous operation you had reason to suspect a problem with your battery, check with an authorized MasterCraft dealer’s service department.

Current models are equipped with a low-voltage battery alarm. In the event that the stereo has been functioning when the boat engine is OFF, the voltage drain on the battery may result in difficulties restarting the boat. To avoid this situation, when the voltage level falls to 10.5 volts, the system will shut off the stereo system and sound an alarm for a period of two (2) minutes to allow the operator time to turn the ignition key ON and start the engine. Doing so will allow the engine’s alternator to recharge the battery.

Charge dead batteries with a battery charger before attempting to start the engine. (Some MasterCraft models offer an optional battery charger; **but never jump-start the battery.**) **Jump-starting from another boat or battery is dangerous!** Charging a dead battery from a third party engine will put undue stress on the alternator, which may cause it to fail.

## **WARNING**

When charging, batteries generate small amounts of dangerous hydrogen gas. This gas is highly explosive. Keep all sparks, flames and smoking well away from the area. Failure to follow instructions when charging a battery may cause an electrical charge or even an explosion of the battery, which could cause death or serious injury.

## **CAUTION**

Crossing cables or jumper cables may result in damage to the electrical components due to incorrect battery connections. Such damages may not be covered by your warranty.

## **Repeat Check For Fuel and/or Exhaust Leaks**

This function should be performed after about three (3)-to-five (5) minutes of running the engine to determine whether any leaks are apparent.



After three (3)-to-five (5) minutes of operation, shut down the engine and ensure that the engine safety starting switch is disconnected. Be certain that the throttle/shift control lever is in neutral. Again, inspect the fuel system as well as possible. Inspect the fuel pump gasket, fastener gaskets, regulator seal and sender gasket for leaks. If the odor of gasoline is strong or if you see visual

evidence of fuel outside the system, cease all operations and take the boat immediately to an authorized MasterCraft dealer's service department to determine the source of the leak. The leak must be repaired before the engine is restarted. Because the lines on late model MasterCraft boats are pressurized, they can be disconnected and/or removed ONLY by using specialized tools that are not available to the public.

Reinspect after the fuel tank has been filled full for the first time of the season.

Note that fuel systems vary by model. The pump-in-tank location on top of the fuel tank will resemble one of the two photos.

**This is important! Fuel leakage can lead to a build-up of potentially explosive fumes within the engine compartment. DO NOT IGNORE OR OVERLOOK THIS INSPECTION AND REPAIR AS NECESSARY!**

Also, recheck that there is no unusual exhaust odors as described prior to starting the engine.

## AFTER EACH USE

### General Cleaning And Storage

Refer to the Corrosion Prevention and Cleaning the Boat sections of this Owner's Manual. After each outing, the boat should receive a general cleaning and drying prior to being stored. Even if the

boat is kept in a slip, owners/operators should wipe down the interior and should periodically remove the boat from the water for a general cleaning.

In instances of boats being left moored in water, it may be necessary to periodically run the bilge pump to clear out water that has intruded into the bilge compartment. Keep the battery fully charged in order to be able to provide this function.

### Inspections

As noted in the Before Each Use section, some functions need to be performed following use of the boat, such as checking the intake strainer or seacock strainer if evidence has shown that debris collects during the outing. Wet debris is often easier to remove.

# SCHEDULED MAINTENANCE

# QUARTERLY EVERY FIFTY [50] HOURS

## Check Safety Equipment And Change Oil

Throughout this Owner's Manual, boat owners, operators and users have been reminded to pay particular attention to any and all safety requirements.

At the fifty (50) hour mark, it is appropriate to check that all required and recommended safety equipment be reviewed for condition and repaired or replaced as necessary. This includes all personal flotation devices. It is also advisable to check that all equipment and personal items onboard have been properly stowed and the routine maintenance performed.

# ANNUALLY - EVERY ONE HUNDRED [100] HOURS

MasterCraft recommends that your annual—or one hundred (100) hour—maintenance requirements be performed by an authorized MasterCraft dealer. An authorized MasterCraft dealership has the proper equipment and technical training to best meet your service needs.

## Annual Maintenance

Some boat owners choose to personally execute some maintenance procedures on their boats. MasterCraft has provided information on several procedures. For safety reasons, a few must be performed by authorized MasterCraft service technicians only, such as anything involving checks and repairs on the fuel line, which is under pressure, and replacement of impellers.

These matters must be addressed on a regular basis, at one hundred (100) hours or annually, whichever comes first. These procedures are in addition to seasonal preparation and winterization (see Storage and Winterization section for additional details). All of these issues are extremely important to continued boating pleasure, as well as long life for the boat, and the critical matter of safety.

Even if the annual maintenance work is completed by an authorized MasterCraft service technician, boat owners and operators should still review this section and ensure that they have some understanding of what is necessary to keep the boat in top condition.

## Check the Engine Mounts

### CAUTION

Some engine parts become very hot during operation. This inspection must be completed while the engine is cool to prevent burns to your skin. Perform this task before starting the boat.

#### Step 1

Ensure the engine is OFF and disconnect the engine safety starting switch. **Be sure that the throttle/ shift control lever is in neutral.** The engine must be cool.

#### Step 2

Open the engine box and locate the four (4) motor mounts.



#### Step 3

Check the tightness of the mounting hardware and adjustment lock-nuts. Securely tighten any loose hardware.

## Check the Propeller Shaft Coupling Alignment

This function is critical to avoiding unnecessary wear and potential damage to the engine as well as the propeller and propeller shaft. Because it is a complex and exacting part of maintenance, this should be performed only by your authorized MasterCraft dealer as part of your annual maintenance.

## Inspect the Exhaust Flaps for Damage

#### Step 1

Ensure the engine is OFF and disconnect the engine safety starting switch. Be sure that the throttle/shift control lever is in neutral.

#### Step 2

Inspect the rubber exhaust flap for signs of deterioration. Take the boat to an authorized MasterCraft dealer to replace the flap if necessary.

## Lubricate Steering System

**For cable systems only (both standard steering and DockStar Handling System); hydraulic steering maintenance must be completed by an authorized MasterCraft dealer only.** Because this process should be completed while all movable components of the drive train are NOT in motion, MasterCraft recommends lubrication be done while the boat is out of the water. The process below is for all MasterCraft boat models. Additional steps listed after are required for ProStar rudders.



### Step 1

Ensure the engine is OFF and disconnect the engine safety stop switch. **Be sure that the throttle/shift control lever is in neutral.** The engine must be cool.

### Step 2

Remove the access panel in the rear trunk compartment.

### Step 3

Turn the steering wheel so that the maximum amount of steering cable is seen (see photo to the right, notice that the engine has been removed, this is not necessary for lubrication).

### Step 4

Use solvent to clean old lubricant from the cable end, pivot and rudder shaft.

### Step 5

Spread a generous amount of white lithium grease over the cable end. Work the steering wheel back and forth and reapply grease.

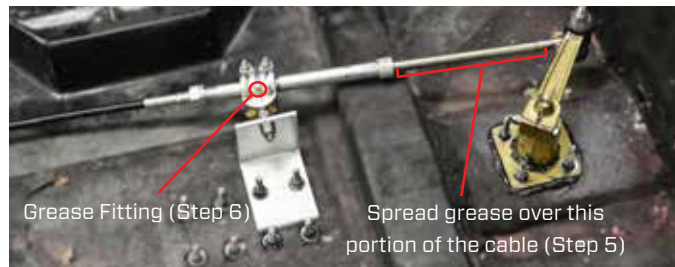

### Step 6

Using the flexible end of a grease gun, give two (2) full shots of white lithium grease to the zerk fitting on the steering tube pivot (circled above). Clean up any old grease purged from the areas.

**NOTE: The ProStar has one additional rudder port zerk fitting. Do NOT use white lithium grease on this rudder port. Use two (2) full shots of Alpha FG2-100, available only from an authorized Master-Craft dealer,**

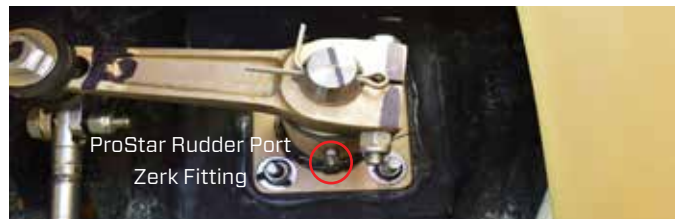

### **Step 7**

Rotate the steering wheel back and forth several times to work the lubricant in.

### **Step 8**

Reinstall the access panel.

## **Lubricate The Throttle System**

Because this process should be completed while all movable components of the drive train are NOT in motion, MasterCraft recommends this be done while the boat is out of the water.

### **Step 1**

Ensure the engine is OFF and disconnect the engine safety starting switch. Be sure that the throttle/shift control lever is in neutral. The engine must be cool.

### **Step 2**

Open the engine box and locate the shift cable end.

### **Step 3**

Shift to full-throttle-forward.

### **Step 4**

Lubricate the cable ends and connections with a coating of waterproof marine multi-purpose grease.

### **Step 5**

Lubricate the pivots and linkages with a light grease.

### **Step 6**

Shift the control lever from full-throttle-forward to full-throttle-reverse several times to work the lubricant in.

## **Check the Ballast Pump Impeller**

This applies only to X Series + XStar boats equipped with some type of ballast system. The number of ballast pumps varies from system to system. Authorized MasterCraft dealers can provide guidance to locate any and all pumps.

### **Step 1**

Remove two (2) of the cover screws and loosen the third screw. Retain the screws for the re-installation process. Swing the cover out of the way to allow access to the impeller location.

### **Step 2**

Using needle-nose pliers, pull the old impeller out of the casing.

### Step 3

Install a new impeller. (It is intentionally larger than the case. While gently squeezing it in, ensure that the paddle wheels angle in the same direction—counterclockwise—all the way around.)



### Step 4

Carefully slide the plate back into place. No silicone is necessary. Due to the built-in gasket, tightening the screws should prevent leakage.

## INSPECT THE COMPLETE FUEL SYSTEM FOR LEAKAGE AND CHANGE FUEL FILTER

Although the boat engine is similar to an automobile engine, the engine compartment differs substantially. The underside of an automobile engine compartment is totally open to the atmosphere. This allows complete air circulation and ventilation. A boat engine is housed in a closed compartment, the underside of which is the bottom (hull) of the boat.

The enclosed engine compartment limits the ventilation of gasoline and oil fumes. Because confined gasoline vapors mixed with a little air can form an explosive atmosphere, it is important to be especially vigilant in performing the following two (2) operations:

### Step 1

Inspect the boat bilge area under the engine for the evidence of oil and gasoline—or any gasoline odor. This inspection should take place the first time the boat is started each day. Raise the engine cover and visually look at the bilge area under the engine.

## Step 2

Run the bilge blower for at least four (4) minutes to ventilate the bilge area each time before starting the engine.



**Gasoline is explosive. If a gasoline odor is present or gasoline is visually observed in the bilge area during inspection, DO NOT START YOUR ENGINE! Remove the ignition key from the ignition switch and call an authorized MasterCraft dealer for service.**

**NOTE:** If there is evidence of loose fuel fittings, deteriorated lines or other problems associated with the fuel system, call an authorized MasterCraft dealer. Fuel system service on later-model MasterCraft boats requires special service tools and special training. Due to the potential for serious consequences when errors occur in servicing the fuel system, MasterCraft strongly encourages all boat owners and operators to seek professional assistance from an authorized MasterCraft dealer's service department whenever any service or perceived problems occur within the fuel system.



All replaced fuel components must meet United States Coast Guard ("USCG") and American Boat & Yacht Council, Inc. ("ABYC") standards, and must be Underwriter's Laboratory ("UL")-approved. Inferior quality components pose a serious safety threat to

**you and others, and the use of inferior components may result in serious injury or death. Resulting damage may void the warranty.**

All MasterCraft models are equipped with a fuel fill cap. These caps are hinged, and they snap open or closed to seal with an audible click. This is important for the system on these boats to operate correctly. Be sure to fully snap the cap shut after each fill.

As part of the Annual Maintenance, the fuel filter must be changed.

Due to the pressurized fuel lines, this maintenance can be done only by authorized MasterCraft dealers.

## Fire Extinguisher And Suppression Units

MasterCraft recommends that boat owners include a check of the fire suppression and extinguisher units during the annual maintenance to be sure that they are always ready for use. Some units may not require annual checks; refer to the signage and labeling on the individual units for further guidance.

## Other Maintenance

Boat owners are required to perform routine regular maintenance as well as annual requirements, as outlined in the engine owner's manual. Some standard or optional equipment on boats may come with their own printed information that includes maintenance required to keep such components in excellent long-term operating condition. Always follow these instructions.



# STORAGE & WINTERIZATION

Storage or winter lay-up requires special preparation to prevent damage to the boat. Since winter storage is an annual event, it presents an excellent opportunity to perform annual maintenance. Check with an authorized MasterCraft dealer's service department regarding your boat's needs to determine if this is an appropriate time for annual service.

Without proper preparation, storage for long periods of time (at any time of the year) may cause harm to various components of the boat and drive train. If the boat has been stored in below-freezing temperatures with water inside the bilge or engine cooling system it may result in major freezing damage to any of the following: the heater, shower, ballast tanks, wash down tanks, coolers, bilge and ballast pumps; or any container or area in which water has been located. This type of damage is not covered under warranty.

Refer to the I/mor Engine Owner's Manual, included in the New Owner Information Package for guidance regarding the storage and winterization of the engine, transmission and components of the drive train. The following procedures will help avoid most potential types of damage during storage for a period not to exceed five (5) months.

## CAUTION

**Winterization is a complex process that may result in damage to the engine, drive train and other components if improperly performed. MasterCraft recommends winterization by an authorized MasterCraft dealer.**

# GENERAL PREPARATION

Before starting you will need the following supplies:

- Sta-Bil® Gasoline Stabilizer
- Fuel filter
- Low tack tape

# FUEL SYSTEM TREATMENT

This preparation needs to be done prior to removing water from the engine, if that will be part of the process.

Boats that are going to be stored for extended periods (more than two [2] weeks) or winterized should have the fuel system treated with stabilizer. Even TOP TIER gasolines will experience some separation and settling during these periods. Of considerable concern is that water condensation will occur within the fuel system. Water is particularly harmful to fuel tanks and engines, therefore, follow this procedure:

## Step 1

The fuel tank should be ninety-to-ninety-five percent (90-95%) full of TOP TIER gasoline. This allows for minimal room in which air can oxygenate the fuel during diurnal cycles (daily periods of expansion/contraction of gasoline vapors and air as a result of temperature changes).

## Step 2

Add a biocide additive in the fuel tank to limit microbial growth in the gasoline. Follow the directions provided by the additive's manufacturer.

## Step 3

Add a fuel stabilizer, such as Sta-Bil® (preferably the Marine grade or Ethanol grade stabilizer) to the fuel tank. Follow the directions provided by the stabilizer's manufacturer.

## Step 4

Run the engine for at least fifteen (15) minutes while in a body of water. This allows for the circulation of the additives throughout the fuel system.

During storage, the tank vents can be sealed. If the vent is sealed, the tank must NOT be completely filled. A ninety-to-ninety-five percent (90-95%) filled tank allows room for expansion, which will be required at certain times when temperatures increase. In addition to preventing water intrusion, sealing can prevent the gumming that occurs when the hydrocarbons in gasoline react with naturally occurring oxygen. This gummy substance plugs up fuel filters and injectors. Sealing the tank helps reduce gumming by significantly limiting the amount of oxygen that is allowed into the fuel tank. If the tank vent is sealed for storage/winterization, it must be unsealed prior to the boat being placed back into service. Failure to do so will result in issues when trying to fill the gas tank in future fill-ups.

**Note:** Fuel stabilizers work ONLY in fresh gasoline. Stabilizers will not cure oxygenated gasoline. Adding a stabilizer when the boat is being prepared for outings after storage will NOT clean the gumming that has occurred or remove water from the fuel tank or otherwise eliminate any problems that have occurred due to failure to properly prepare the fueling system for storage.

Engine manufacturers suggest using Federal or State of California reformulated gasoline whenever possible as it stores as well or better than conventional gasoline.

Even quality gasoline that has been properly prepared for storage should never be stored for a period to exceed one (1) year.

## CAUTION

Fuel systems on all boats MUST be properly prepared for storage periods exceeding two (2) weeks, as outlined in this Owner's Manual. Failure to do so may void the warranty.



# WINTERIZATION PREPARATIONS

## Step 1

Lubricate the throttle and shift linkages and cables with multi-purpose grease.

## Step 2

MasterCraft recommends that batteries be removed from the boat for winter storage. Batteries should be fully charged before being stored in a cool, dry location, protected from the elements. Fully recharge the batteries before re-installation in the boat. Never store batteries close to heat, spark or flame-producing devices.

## Step 1

Remove the bilge drain plug immediately after taking the boat out of the water. After a general bow-to-stern washing, raise the bow of the boat higher than the stern to allow as much water as possible to drain from the bilge.

## Step 2

Thoroughly clean the hull, deck and interior of the boat as soon as it is removed from the water. Cleaning while the boat is still wet is recommended rather than waiting until the boat is taken out of storage. Any marine growth in or on the hull will be wet and easier to remove. Be sure to leave the boat's storage and engine

compartments opened up so they can properly air dry and prevent mildew from trapped moisture. (See the Cleaning section of this Owner's Manual.)

## Step 3

Apply a coat of wax to the entire surface of the boat. MasterCraft Premium Marine Wax provides excellent coverage and is recommended.



## Step 4

If the boat is equipped with a heater or ballast bags, be sure to disconnect the hoses (ballast hoses and heater circulation pump hoses) and drain any remaining water in the lines to avoid freezing. Even small amounts of water in any of these areas can cause significant damage upon freezing. Such damage is not covered under warranty.

## CAUTION

**Be sure that disconnected hoses will not become entangled in the engine belt when the engine turns over. Failure to do so may result in damage to the engine and/or critical boat systems.**

### Step 5

For boats equipped with an engine flush kit you must winterize the engine flush fitting mounted to the transom of the boat:

- Remove the boat from the water.
- Drain the engine according to the Ilmor Engine Owner's Manual included with the Owner's Manual Information Packet.
- Add one (1) gallon of marine grade antifreeze to a five (5) gallon bucket.
- Attach a garden hose to the flush valve adapter mounted on the transom. Place the other end of the hose in the bucket with the antifreeze.
- Start the engine and allow the engine to draw the antifreeze into the motor. DO NOT EXCEED 1100 engine RPM. Once all the antifreeze has been drawn out of the bucket and into the engine, turn the engine off to prevent loss of antifreeze or overheating.

### Step 6

Use duct tape to seal exhaust flaps to prevent dirt and nesting rodents from entering the engine or exhaust system.

### Step 7

On X26 boats equipped with a head, clean the tanks with a mild cleaner or warm soapy water that will not harm the tank. Avoid all petroleum-based household cleaners. Always clean and dry the head before storage. Failure to do so may cause unnecessary odors and damage to the tanks, which are not covered under warranty. If using antifreeze in the head, drain the potable water tank and add freshwater antifreeze to the potable water tank. Flush the antifreeze and water mixture through the head and into the waste holding tank. Then empty the holding tank. Never use automotive-type antifreeze in the freshwater system.

### Step 8

If the tower will be lowered during storage, be certain that the tower does not rest on the boat upholstery or on any support that rests on the upholstery. The tower or support(s) may leave a permanent imprint on the upholstery. This is not covered under warranty. For ProStar models use the black tower support legs included with the boat from the dealership to keep the tower from resting on the motorbox.

### Step 9

Cover the boat with a boat cover or tarp.

**Note: If the boat is to be stored outside and subject to accumulations of snow, water and ice, a MasterCraft mooring cover with anti-pooling poles should be used. If you do not have a MasterCraft mooring cover, a tarp or other water resistant cover**

should be used with a support so that the covering will not sag, rip or tear, thereby allowing water to enter the boat. Two-inch diameter PVC plumbing pipe is ideal for this purpose. It is readily available at local hardware stores, and it is easy to work with. Also, its rounded shape will prevent damage to the canvas.

## BALLAST SYSTEM WINTERIZATION

Ballast tanks, pumps, hoses and fittings must be properly winterized to prevent freezing damage during winter storage. Because of the complexity of preparing a ballast system for winter storage, as well as the possibility of extreme damage to the ballast system if a preparation error is made, MasterCraft recommends scheduling an appointment with an authorized dealer's service department to have a certified technician to perform all winterization procedures, including ballast winterization.

MasterCraft uses a -50 F RV type, nontoxic, propylene glycol based antifreeze to winterize every boat built at the factory. Any antifreeze meeting these requirements is acceptable for MasterCraft engine, ballast, and freshwater system winterization. Be aware that colder climates may require this same type of antifreeze with a -100 F temperature rating.

### **To winterize X, XT, and ProStar models:**

1. Completely empty all ballast tanks and bags of any water that may be in the ballast system.
2. Remove all ballast bags (if applicable) and re-attach the bridge connector (pictured right) to the ballast thru hull vent hose and the hose to the ballast hard tanks. Completely drain and store the bags

in a dry place.

3. With the rear ballast bags removed and the bridge connector in place, identify the three ballast thru-hull vents (see guide to each model in this Owner's Manual. Most models have two vents on each hull side toward the stern, and one vent forward of the helm on the starboard side). The ProStar only has one optional hard tank ballast, see guide to each model in this Owner's Manual for the ProStar's vent location.



4. Add one gallon of -50 F RV type nontoxic propylene glycol based antifreeze to each of the three thru-hull vents (the ProStar only has one vent). Colder climates may require this same type of antifreeze with a -100 F temperature rating.
5. Once the antifreeze is in all three ballast zones, use the manual

ballast override switches mounted on the dash to empty the tanks. This will push antifreeze through the ballast system, across all pumps, hoses, fittings and intake valves. Be cautious while using the override switches as antifreeze will be pumped out of the intakes mounted to the bottom of the boat.

Some models have check valves equipped on the ballast lines. On such models pour a small amount of antifreeze into those vents (see guide to each boat in this Owner's Manual). The antifreeze will sit in the line during storage.

## To winterize NXT Series boats:

1. Completely empty all ballast tanks and bags of any water that may be in the ballast system.
2. Remove all ballast bags (if applicable) and re-attach the bridge connector (pictured to the left) to the ballast thru hull vent hose and the hose leading to the ballast hard tanks. Completely drain and store the bags in a dry place.
3. With the rear ballast bags removed and the bridge connector in place, identify the three ballast thru-hull vents on the hull sides of NXT series boats.
4. Add one gallon of -50 F RV type nontoxic propylene glycol based antifreeze to each of the three thru-hull vents. Colder climates may require this same type of antifreeze with a -100 F temperature rating.
5. Because the NXT Series uses a different style ballast system than

X and XT series models, the antifreeze will stay in the ballast system during storage rather than being immediately pumped out.

Upon reactivating the boat the first time after storage, run the ballast system to pump out the antifreeze (the engine must be on and the boat must be in the water).

## **WARNING**

**The original bridge connector in the ballast system must be reinstalled if the optional plug-in bags are removed from the system. Failure to do so will result in any water in the ballast system evacuating into the storage compartment, potentially flooding the storage compartments. This could sink the boat, resulting in serious injury or death.**

# REACTIVATING THE BOAT AFTER STORAGE

## Step 1

Remove duct tape from exhaust flaps.

## Step 2

Fully charge the battery(ies) and install them in the boat, following all safety precautions associated with changing batteries.

## **CAUTION**

Often, batteries that have been stored over winter will require recharging. Only an authorized battery charger should be used to charge the battery(ies) in MasterCraft boats. Use only a three-stage or more battery charger. It is important that the operator never turn a battery charger immediately to “start,” as the sudden jolt of voltage may cause damage to the electrical system, particularly the control modules for the ballast system. Regardless of the time of year, care should always be used when charging a battery(ies).

## Step 3

Follow all instructions for reactivating the engine and drive train as detailed in the Ilmor Marine Engine Owner’s Manual.

**NOTE: Due to the complex nature of the engine and drive train re-activation process, MasterCraft recommends having an authorized MasterCraft or Ilmor dealer perform this function.**

#### **Step 4**

Ensure that all drain plugs throughout the boat and drive train have been reinstalled to avoid unwanted water intrusion.

#### **Step 5**

If applicable, reconnect and verify that all hoses to the heater, the head, the fresh water wash down, and the wet bar are in proper working condition with no leaks.

#### **Step 6**

Check the engine compartment and bilge for signs of nesting animals. Clean as necessary.

#### **Step 7**

Check the entire engine system for fluid, oil and coolant levels. Add as necessary.

#### **Step 8**

Check the entire engine for cracks or leaks caused by freeze damage.

#### **Step 9**

Check all hose clamps for tightness. Install the bilge drain plug and the rear drain plug (if applicable).

#### **Step 10**

Grease the propeller spline and install the propeller.

#### **Step 11**

Perform daily maintenance as noted previously in this Owner's Manual. If it was not done prior to storage, perform annual maintenance as well.

#### **Step 12**

If the boat is equipped with the optional fresh water cooling system and was drained for storage, fill the system with fresh coolant solution per instructions in the Ilmor Engine Owner's Manual.

#### **Step 13**

For all models, with the boat in the water, cycle the key ON and then OFF two (2) or three (3) times, allowing ten (10) seconds between key cycles, before cranking the engine. This allows the fuel pump to prime the fuel lines. Start the engine. In the event the engine does not respond, allow a two-minute cool-down period for every thirty (30) seconds of cranking. When the engine fires, keep a close watch over the gauge readings and check for leakage and abnormal noises. Keep speeds low for the first fifteen (15) minutes to allow the engine to reach normal operating temperatures.

## **PROPELLER MAINTENANCE**

Propeller damage is caused by striking solid objects. If the propeller is not rotating at the time it strikes a solid object, the damage is

usually confined to just one blade and may be difficult to see. If the propeller is rotating when it strikes an object, usually the resulting damage can easily be seen on all blades.

## CHECKING/REPAIRING PROPELLERS

### Step 1

Ensure the engine is OFF and the emergency safety stop switch is disconnected.

### Step 2

Clamp a small rule scale to the shaft strut, parallel to the shaft so that the end of the scale is  $3/32$ -inches from the leading edge of a propeller blade.

### Step 3

Rotate the propeller slowly. There should be no more than  $3/32$ -inch variance between the blades. If the propeller is damaged, see an authorized MasterCraft dealer for repair or replacement as necessary.

## CHANGING PROPELLERS



### Step 1

Ensure the engine is OFF and the engine safety starting switch is disconnected.

### Step 2

Remove and discard the cotter pin.

### Step 3

Remove the propeller nut with a  $1\ 1/8$ " wrench.

### Step 4

Tap the center hub of the propeller with a rubber mallet to release the propeller. Inspect the shaft and propeller splines for damage.

### **Step 5**

Thoroughly clean and apply a light coat of waterproof marine multi-purpose grease to the splined area of the shaft and propeller.

### **Step 6**

Align the splines and carefully install the propeller onto the shaft.

**DO NOT FORCE THE PROPELLER INTO PLACE. If necessary, gently tap the propeller into place with a rubber mallet.**

### **Step 7**

Install the propeller nut and tighten it into place to 50 lb.-ft. with a torque wrench.

### **Step 8**

Install a new cotter pin and bend the ends around the shaft to lock the propeller on the shaft.





MasterCraft X

# THE MASTERCRAFT TRAILER



# TRAILERS

Congratulations on the purchase of your new custom-built MasterCraft trailer. You and your new MasterCraft boat now have access to thousands of lakes, rivers and other waterways.

MasterCraft custom designs and builds trailers to perfectly match every boat that comes off our assembly floor. MasterCraft trailers have been engineered and constructed for years of trouble-free use. To maintain proper function and to keep your trailer in top condition, some routine care and maintenance is necessary.

The purpose of this section of the Owner's Manual is to provide the information that owners and operators need to keep their trailers in exceptional running condition for years to come. Please read and follow the warnings and instructions carefully. Also, because not all trailers are exactly alike, be sure to read and comply with any warnings and additional information supplied by MasterCraft and its parts suppliers within the owner packet.

## National Highway Traffic Safety Administration (NHTSA)

If you believe that your trailer has a defect that could cause a crash or could cause injury or death, DO NOT USE THE TRAILER. You should immediately inform the National Highway Traffic Safety Administration (NHTSA) in addition to notifying MasterCraft Boat Company. If NHTSA receives similar complaints it may open an investigation, and if it finds that a safety defect does exist in a group of trailers, it may order a recall and remedy campaign. However NHTSA cannot become involved in individual problems between you, your dealer, or MasterCraft Boat Company.

To contact NHTSA, you may call the Vehicle Safety Hotline toll-free at 1-888-327-4236, (TTY: 1-800-424-9153); go to <http://nhtsa.safercar.gov>, or write to: Administrator, NHTSA, 1200 New Jersey Avenue SE, Washington DC 20590. You can also obtain other information about motor vehicle safety from <http://www.safercar.gov>.

## INTRODUCTION

Please take a few minutes to read this section of the Owner's Manual completely before using your MasterCraft trailer for the first time. It provides substantial information about the trailer. If you still have questions after reviewing this information, be sure to contact an authorized MasterCraft dealer. It is important that any and all trailer operators possess as much knowledge as possible.

**NOTE:** The information given in this Owner's Manual may not be applicable to international laws or rules of the road. If you have any questions, please contact your local authorities.



**Before towing a trailer, be sure to read and understand this Owner's Manual.**

## A Proper Match

The key to carefree boat trailering is properly matching a trailer to a boat. At MasterCraft we design our trailers to be a perfect match for our boats. We build all of our trailers in house to ensure quality and the best trailering experience possible. Each trailer that comes off our manufacturing line was designed specifically to support the hull and full weight of its matching boat.

## TRAILER MAINTENANCE AND QUICK TIPS

### Chips In The Paint

Especially on the axles and frame of the trailer, paint chipping generally results when these surfaces are subjected to repeated or significant impacts by various objects while in transit. Usually, these

are gravel, stones, asphalt chips or other debris on roadways, which are thrown up by the rear tires of the tow vehicle. Over time, rust may develop where paint has been chipped away. Such damage is not covered by the Limited Warranty for the trailer. To avoid chipping the paint on the trailer and to preserve its condition, consider attaching mud flaps behind the tow vehicle's rear tires. Exceptional care should be taken to travel as slowly as practical when traveling on gravel or other loose surfaces.

## Lubrication

To ensure proper operation of the trailer jack, wipe it down and lubricate it on a regular basis.

## Salt Water Effects

If the trailer is backed into salt water, you must completely and thoroughly wash the trailer in fresh water to prevent rusting. Salt water is very corrosive, even on galvanized trailers, and can corrode the braking system. Exposure to salt water can also cause brake pads to stick and malfunction.

## Regular Cleaning

The trailer will look better and last longer if it is rinsed off with fresh water several times a year. If the boat is run in brackish or salt water, the trailer should be rinsed thoroughly after every trip because of residual effects of the brackish or salt water. An annual washing with a mild detergent and waxing with an auto wax will also help to keep the trailer bright and clean.

## Braking System

Check the braking system at the beginning of boating season and again at the conclusion, along with the wheel bearings. If there is anything that appears to be worn or leaking, take the trailer to an authorized MasterCraft dealer for a check and possible repair.

## Tow Vehicle Approach

Tow vehicles must always approach the trailer slowly prior to being hitched to the trailer. This allows the operator to retain greater control. Hard impact with the trailer or improper alignment on the trailer can result in damage to the tow vehicle, boat and/or the trailer, and any such damage is not covered under warranty.

## Seven-Wire Connector

The tow vehicle must have a seven-wire connector in order for disc brakes and the trailer lights to function properly. It is important to connect the seven-wire connector on the trailer to the seven-wire connector on the tow vehicle. MasterCraft recommends applying dielectric grease to the terminals inside the 7-pin trailer connector at least once per year. This helps protect the terminals from corrosion, which is inherent to a non-sealed connection.



## Load Limit

The correct method for determining the load limit is to:

- Locate the Gross Vehicle Weight Rating (GVWR) statement on the trailer tongue. (The number shown equals the total weight capacity for the boat and all contents that can be safely loaded and towed on the trailer.)
- Determine the combined weight of the boat and all contents of the boat being loaded onto the trailer. The boat's weight is listed in the guide to individual models section of this owner's manual. (The total weight of the boat and contents may not safely exceed the available cargo load capacity listed on the trailer tongue).



## WALK AROUND INSPECTION

The majority of potential roadside issues can be eliminated by a walk-around visual inspection of the trailer. This should be done after hitching the trailer to the tow vehicle, and again at each fuel or rest stop.

## Make A Quick Visual Check Of:

- Coupler
- Safety cables
- Emergency brake cable
- Wiring connector
- Tie-downs
- Tires

## Look For:

- Any obvious fluid leaks
- Unusually hot brakes or hubs
- Damage caused by road hazards
- Low tire pressure

Make a point to pay particular attention to the right (starboard) side of the trailer, as this is typically where most road hazard damage occurs.

## TRAILER MANEUVERING TIPS

### Backing Up

When backing up, place your hand at the bottom of the steering wheel. To turn left, move your hand left (rotate the wheel clockwise). To turn right, move your hand right (rotate the wheel

counterclockwise). Back up slowly. Because mirrors cannot provide all of the visibility you may need when backing up, whenever possible have someone outside at the rear of the trailer to guide you while backing up. Use slight movements of the steering wheel to adjust direction. Exaggerated movements will cause greater movement of the trailer. If you have difficulty, pull forward and realign the tow vehicle and trailer and start over.

## **Parking**

When parking, try to avoid parking on steep grades. If possible, have someone outside to guide you as you park. Once stopped, but before shifting into park, have someone place blocks on the downhill side of the trailer wheels. Apply the parking brake, shift into park, and then remove your foot from the brake pedal. Following this parking sequence is important to be sure your vehicle does not become locked in park because of extra load on the transmission. For manual transmissions, apply the parking brake and then turn the vehicle off in either first gear when parked uphill, or reverse gear, when parked downhill.

## **Uncoupling**

When uncoupling the trailer, place blocks at the front and rear of the trailer tires to ensure that the trailer does not roll away when the coupling is released.

## **Unbalanced Load**

An unbalanced load may cause the tongue to suddenly rotate upward; therefore, before uncoupling, place jack stands under the rear of the trailer.

## **Difficult Towing**

If a trailer seems hard to tow or sways to one side, a brake rotor may not be rotating freely. If this appears to be the problem, immediately contact your authorized MasterCraft dealer for assistance. Ignoring this symptom could result in brake failure.

## **Check Trailer Jack and Lug Wrench**

The trailer jack and lug wrench that came with the tow vehicle may also work on the trailer, but don't count on it, check it to be sure before you need it.

## **Road Trip Kit**

Make up a special road trip kit and carry it with you on all trips. The kit should include a spare wheel and tire, lug wrench, wheel chocks, bearing grease, spare strap for tie-downs and winch, extra lights, wheel bearings and road flares.

## **Insurance**

Some insurance policies do not provide coverage when towing a trailer. Check the policy or call the insurance agent to be certain that you have appropriate insurance coverage in place.



## **WARNING**

The total weight of the boat, engine, fuel, water and gear must not exceed the trailer's maximum load-carrying capacity. Overloading can cause instability and loss of control while towing, which may result in death, serious injury or property damage.

## LOAD-CARRYING CAPACITY



Check the certification label attached to the front left side of the trailer. This is very important as it shows the maximum load-carrying capacity of the trailer. It will also show the Gross Vehicle Weight Rating (GVWR). Be sure that the total weight of the boat, engine, gear and trailer does not exceed the GVWR.

**NOTE:** The gross Vehicle Weight Rating (“GVWR”) is the estimated total weight of a road vehicle that is loaded to capacity, including the weight of the vehicle itself. Therefore, the maximum load-

carrying capacity of the trailer is the GVWR less the weight of the empty trailer.

Be especially careful to avoid overloading the trailer by putting heavy baggage, camping gear, etc. inside the boat.

Do not tow the boat with a water-filled bladder or with water in the ballast tanks. Failure to empty the contents of bladders or ballast tanks will cause the tongue weight percentage to be incorrect. Towing with water-filled bladder(s)/ballast tank(s) may not only exceed the total weight limits for the trailer, but may also result in the improper distribution of the weight on the trailer, thereby making towing difficult and/or causing instability when towing. This can be very dangerous to the driver, any passengers and to other motorists.

## **WARNING**

**NEVER** tow with water in ballast tanks or bags. Failure to empty ballast tanks, bladders or bags on the boat prior to towing can result in improper weight distribution, which can cause towing instability. This could cause the driver to lose control of the tow rig, resulting in death or serious injury to the driver, any passengers and/or to other motorists, or property damage.

Do not tow the boat with wakeboards, skis or other gear left on the board tower racks. Doing so may void the warranty and cause damage to the boat or to vehicles following behind as boards and/or racks may become disengaged.

## **WARNING**

Do not tow with any gear in the tower racks, even if the gear appears to be secure. The racks are not designed to withstand air pressure from highway speeds. Gear may become dislodged, potentially causing damage to the boat or following vehicles.

## **CAUTION**

Loose objects may damage the boat and/or trailer. Such damage is not covered by the warranty.

## **Weight Distribution**

### **WARNING**

**Improper weight distribution within the boat can cause instability and loss of control while towing, which may result in death, serious injury or property damage.**

Improper weight distribution can cause a boat trailer to fishtail (sway from side to side) as it moves down the highway, putting excessive strains on both the trailer and the tow vehicle, which increases gas consumption and may cause an accident. The most effective way to guard against fishtailing is to make sure the weight load on the trailer is properly distributed.

It is extremely important that a minimum of five percent (5%) and a maximum of ten percent (10%) of the total weight on the trailer is on the trailer coupling ball when the tongue is parallel to the ground. A quick way to measure parallelism is to measure the distance from the ground to the bottom of the frame at or between the tires, and measure from the ground to the bottom of the frame at the swing tongue. Ensure that the measurements are even.

Check the tow vehicle owner's manual prior to first time use.

The importance of sufficient weight load on the trailer tongue (creating downward force on the hitch ball) cannot be over-stated.

## **THE TRAILER HITCH**

There are two basic types of trailer hitches: a weight-carrying hitch and a weight-distribution hitch. A weight-carrying hitch is recommended for use with a MasterCraft boat and trailer. However, weight-distributing (equalizing) hitches may be used.

If using a weight-distributing hitch, the chain must be vertical (straight up and down) under the pulling load where the actuator is extended. Excessive tongue weight beyond the actuator rating must be avoided as it will reduce the brake performance and could damage the actuator. Always follow the hitch manufacturer's instructions. Before deciding which type of hitch to use, consult the tow vehicle manufacturer for recommendations.

Be sure that the total weight of the trailer-boat rig does not exceed the hitch's load capacity. The maximum permissible weight for the hitch should be stamped on the hitch. The hitch should also provide a place for attaching the trailer's safety cables—two rings or holes on either side of the hitch ball. Be sure the hitch ball is the correct size to match the coupler on the trailer. The correct ball diameter is marked on the trailer coupler.



## **WARNING**

Failure to use a two-inch (2") hitch ball and mount rated to 8500-lbs. or higher, where required, may result in failure of the hitch on the tow vehicle and a loss of control of the trailer while towing, which may cause serious injury or death.

A truck or van using a step bumper as the hitch platform will need to have safety cable attachments such as eye-bolts, as well as a hitch

ball, which has been installed according to the Society of Automotive Engineers (SAE) J684 Standard. Installing a light or heavy-duty hitch can be a major undertaking. The hitch and its installation must meet the SAE J684 Standard. It is recommended that the job be done by a professional. An authorized MasterCraft dealer can offer advice.

To ensure that the boat is riding properly on the trailer supports, the trailer should be in a level position when hitched to the tow vehicle. With the trailer hooked up to the tow vehicle and the jack stowed, a quick way to measure parallelism is to measure the distance from the ground to the bottom of the frame at or between the tires, and measure from the ground to the bottom of the frame at the swing tongue. Ensure that the measurements are even. Failure to run the trailer parallel to the ground may prematurely activate the surge brakes. This can be corrected in a number of different ways. For example, air pressure adjustable shock absorbers may be installed on the tow vehicle, or you can switch from a weight-carrying to a weight-distributing hitch. Consult with the tow vehicle's dealer or manufacturer.

## **WARNING**

If the total weight on the loaded trailer exceeds the load capacity of the hitch on the tow vehicle, the trailer may break free, which may result in serious injury or death and/or property damage. **Never Attach The Trailer To Any Device Between The Trailer And The Tow Vehicle.**



The photo shows an example of an improper device attached between a trailer and tow vehicle that may create a dangerous condition for towing a boat. Devices like the one shown in the photo may be built or marketed with the idea of improving stability in towing, but instead, devices of this nature may create a very unstable condition in which control of the trailer may be lost during towing. The MasterCraft trailer was designed and built to be attached directly to the tow vehicle, and the trailer should only be attached in that manner. This is especially critical in maintaining the proper weight balance, which is described in more detail in this section of the Owner's Manual.

## **WARNING**

**Trailer sway control devices that restrict the operation of the actuator MUST NOT be used. These devices can limit the effectiveness of the trailer brakes.**

## **Safety Cables**

The safety cables on a MasterCraft trailer provide added security so that the trailer will not become detached from the tow vehicle when underway. These cables conform to the Society of Automotive Engineers (SAE) J684 standard for trailer coupling and hitches automotive type. If it ever becomes necessary to replace these cables, ensure that the replacement cables meet the SAE J684 standard.

## **WARNING**

**Failure to properly attach the safety cables and brake actuator break-away cable between the trailer and the tow vehicle may result in a runaway trailer if the trailer coupler becomes detached from the hitch. This may cause serious injury, death and/or property damage.**

## **WARNING**

**The strength rating of EACH safety cable must be equal to or exceed the trailer's GVWR (Gross Vehicle Weight Rating).**

Before each trip, ensure that the safety cables are correctly attached between the tow vehicle and the trailer. Secure the breakaway cable to the bumper or frame of the tow vehicle as close to center as possible but do not attach to the safety cables.

As noted above, the trailer hitch should provide a place for attaching safety cables, through holes or rings on both sides of the hitch ball. It is strongly recommended, and most states require, that the cables be crossed under the trailer tongue (e.g., the cables on the left side of the trailer tongue should be attached to the hole or ring on the right side of the



hitch ball, and the right side cable should be attached to the hole or ring on the left side of the hitch ball). If the trailer separates from the hitch ball doing so will slow the process of the dropping of the trailer tongue. The cables should be rigged as tightly as possible, with just enough slack to permit tight turns. If for any reason it becomes necessary to replace a safety cable, do not substitute with any part other than a genuine MasterCraft cable.

## Breakaway Cable

Secure the breakaway cable to the bumper or frame of the tow vehicle as close to the center as possible, but do not attach it to the safety chains. The cable **MUST** hang clear of the trailer tongue and be long enough to permit sharp turns without pulling the cable to prevent the brakes from being engaged. The intent of the breakaway cable is to apply the brakes if the safety chains fail. Do not loop an S-hook over the breakaway cable to attach it.

### **WARNING**

**Never tow a trailer without the breakaway cable secured to the tow vehicle.**

If the breakaway cable is accidentally pulled and the brakes applied, determine why it happened and fix the problem. Inadvertent setting of the brakes by pulling the breakaway cable is a common mistake. To prevent light pulls from accidentally setting trailer brakes, a small metal clip has been installed on breakaway cables in front of the indicator bead. The clip will not inhibit the action of the

breakaway mechanism during actual breakaway conditions. However, if breakaway should occur, the clip will be destroyed and should be replaced. Spare clips are available through authorized MasterCraft dealers. To retract the breakaway cable, slide the coupler fully forward and push up on the push rod release bracket located on the underside and behind the hitch ball socket. This allows the bead to retract into the actuator. This releases the trailer brakes. Install a new clip on the breakaway cable in front of the bead.

### **CAUTION**

**The breakaway system must be reset anytime the cable has been pulled.**

## Checking and resetting the breakaway cable:

If pushing up on the bracket does not release the brakes or it is hard to push, insert a pry bar into the 5/16" hole behind the bracket. Use the pry bar to (gently) stroke the push rod backwards and relieve the load on the bracket. Push up on the bracket and hold it up while releasing the pry bar. The push rod release bracket should now move freely and brakes should be released. Check to be certain the actuator is reset. Extend the actuator fully. Remove the cap from the top of the actuator and pull the plug from the top of the reservoir cover. While looking at the fluid in the reservoir, manually compress the actuator. In the first 1/8" of coupler movement the fluid in the reservoir should splash or ripple slightly. If it does, the actuator is working properly.

### **Stroking the push rod to release the brakes:**

If the brakes cannot be released using the method described above, or if the push rod release bracket will not move, it is damaged beyond serviceability. Contact an authorized MasterCraft dealer for assistance and replacement parts.

### **How to install the breakaway cable clip:**

The breakaway cable clip is installed on the breakaway cable to prevent inadvertent pressurization of the trailer brakes if the cable is lightly pulled by accident. If the breakaway cable is pulled during an emergency situation, the clip will be destroyed. The breakaway system must be reset by pushing up on the tab located under the coupler and the clip must be replaced. Contact your Authorized MasterCraft dealer for a replacement clip.

## **Trailer Winch Assembly**



**Maintain a firm grip on the winch handle at all times. Never release the handle when the lever is in the unlocked position with a load on the winch because the handle will spin forcefully under these conditions. This may cause serious injury. If the winch is released and begins to spin forcefully, do NOT attempt to halt the spin.**

Prior to each use of the winch, check for the proper ratchet operation. Do not use the winch if it is damaged. Seek immediate repairs. Never use the winch handle as a handle for pulling or maneuvering the entire trailer or other equipment.



Never pull on the winch handle against a locked ratchet. Never exceed the rated capacity of the winch. Excessive loads may cause premature failure. Never apply a load on the winch with the strap fully extended. Keep at least two full turns of the strap that is on the reel. Inspect the condition of the winch strap.

Using a damaged or worn winch strap may result in serious injury or damage. Check the winch straps frequently. The strength in these can deteriorate from exposure to weather, ozone and ultraviolet light (direct sunlight). If a strap becomes frayed or worn, replace it immediately with a new one.

A heavy grease should be applied to the winch's gears to provide a free-running drive and to minimize the effort you have to expend to crank the boat onto the trailer.

The winch is intended solely as an aid to loading the boat on the trailer. It is not recommended to use the winch as the sole method for loading the boat onto the trailer. However, it is a satisfactory assistant in the event of engine power loss. It is not intended or adequate to be the sole means of holding the boat in place while loading the boat onto the trailer. Proper tie-downs fore and aft must be used.

## Swing Tongue



Ensure the swing tongue is folded fully forward, the pivot pin is installed, and the keeper pin is installed in the bottom of the pivot pin before towing. When folding the swing tongue open or forward to the fully closed position, be sure that the brake hose is not kinked or pinched in any way. A pinched or kinked brake hose will cause the brakes to drag and overheat.

**NOTE:** Because all pins, fasteners and other components are specially designed, high-strength components, any component

replacement or adjustment of the swing tongue should be performed by your authorized MasterCraft dealer.

## How to Attach the Trailer

To connect the trailer to the tow vehicle, open the coupler mechanism (instructions below). When necessary, raise the trailer jack. Slowly back up the tow vehicle until the hitch ball is under the coupler. This is easier to perform with another person standing beside the trailer and guiding the driver.

### **WARNING**

**Do not move the trailer to the tow vehicle. When the trailer is moved without a tow vehicle, the brakes do not work.**

If the latch accidentally opens, the coupler could detach from the hitch ball. The hitch pin should fit easily into the hole. If it does not, the coupler latch is not completely closed. Every time the coupler is attached to the hitch ball, be sure the coupler completely covers the hitch ball and the lift handle will not open. If the hitch pin is damaged or lost, contact an authorized MasterCraft dealer to purchase a replacement pin.

### **WARNING**

**You must install either the hitch pin that is supplied or a padlock (1/4" or 5/16" shank) into the hitch pin hole before towing to prevent the coupler latch from accidentally opening.**

## To Open the Coupler



Remove the hitch pin from the hole in the side of the coupler. Slide the lock/latch to the right which should allow the latch to spring upward. The coupler should unlatch easily. If not, the ball may be over-sized or egg-shaped, foreign matter could be lodged in the coupler ball socket, or the coupler is pushing on the hitch ball. Check to make sure the wheel on the tongue jack is raised or that the rig is not parked downhill. Correct these conditions, and then try to open the handle. If the tongue jack is forcing the front of the trailer up or the trailer is pushing against the tow vehicle, it can result in failure of the coupler to open properly.

## To Close The Coupler

Place the coupler over the ball, lower the coupler and close the latch and slide the lock forward.

An audible “click” will be heard. The latch should close with finger pressure. If the latch will not close freely, the ball is not fully inserted into the socket, it is over-sized or egg-shaped, or the latching mechanism is damaged. **DO NOT FORCE THE HANDLE.** If necessary, replace the ball with a quality unit that meets SAE specifications.

Insert the hitch pin into the hole on the side of the coupler. The hitch pin will not go in the coupler if the hitch ball is not seated properly.

## **WARNING**

**DO NOT tow the trailer with the handle open or if the latch handle will not remain closed. Check to see that the coupler is locked. If the latch is damaged, contact an authorized MasterCraft dealer for assistance.**

## Lights

## **WARNING**

**Before each use make certain that all trailer lights are in proper working order to reduce the risk of serious injury, death and/or property damage.**

The MasterCraft trailer harness was specifically designed to mate with the tow vehicle’s equipment. This harness is designed to disengage the trailer brakes with the use of the tow vehicle’s harness.



**NOTE: See an authorized MasterCraft dealer if the tow vehicle does not have the correct trailer harness.**

The trailer lights are brighter when the trailer is submerged. A sensor notifies the system when the trailer ramp is under water, and the lights will be at their maximum luminance. When the trailer is removed from the water, the lights will automatically dim. There is no consumer control for the system.



### **To keep trailer lighting system in good working order:**

Be sure the white ground wire is properly connected to the master cylinder. Replace any parts that are damaged or worn.

A small amount of waterproof grease on the plug contacts and light bulb bases will help prevent rust and corrosion.

Before every trip, check for burned out or broken bulbs, cracked or broken light lenses, etc.

## **Trailer Runway Lights by XKGlow**

XKGlow trailer runway lights are available on all MasterCraft Trailer Models. The lights are used for a number of different purposes, but generally they are designed to beautifully light a boat resting on its trailer. For instructions on operating and troubleshooting the XKGlow runway lights, see the XKGlow Operating Manual included in your boat's Information Packet.

# HUBS, WHEEL BEARINGS, AXLES AND LUBRICATION



Trailers equipped with Dexter Marine Products or Georgia actuators are also equipped with Vortex hubs and spindles. The hubs are pre-greased and assembled at the factory. As a result, they should not require any additional adjustments. The Vortex hub uses tapered roller bearings adjusted to a maximum .006 end play. The twelve-sided castle nut easily maintains this maximum .006 end play. The configuration requires a minimal amount of end play that is factored in at the time of assembly.

The rear seal rides on a stainless steel wear sleeve. This provides longer life for the seal as the surface does not corrode. Corroded or rusted seal surfaces act like sandpaper on the seal, causing premature seal failure. Every reasonable attempt has been made to prevent this.

Vortex lubrication makes changing or adding grease easy because the hub does not need to be removed. Most axles have a threaded grease cap, and it is easy to remove and replace.

Vortex requires Lucas Oil Marine grease, a premium lithium-based complex grease that is fortified with rust and oxidation inhibitors, and high-pressure additives that provide a high degree of moisture resistance and wash-out properties.

## CAUTION

**Use only Lucas Oil Marine Grease when adding or replacing grease in the Vortex hub. Using any other grease will void the warranty.**

### Adding Grease or Removing Hubs

The Vortex hub/spindle is designed to be a no-maintenance hub for six (6) years. Remove the Vortex grease cap, unscrewing threaded caps in a counterclockwise rotation. On the press-in style caps, simply remove the rubber plug in the center to grease the bearings, or knock gently with a hammer, preferably a rubber mallet, if removing the entire hub.

Use a standard grease gun loaded with Lucas Oil Marine Grease to pump the grease into the zerk fitting located on the end of the spindle.

- Pump the grease into the zerk fitting while slowly rotating the wheel. Grease will flow out of the hub around the front bearing.
- When the grease appears to be the new clean grease, remove the grease gun.

- Replace the Vortex grease cap. With the threaded cap, turn in a clockwise rotation until the o-ring on the cap is in contact with the hub surface. Turn an additional one-quarter (1/4) turn to seal the Vortex cap to the hub. (Similar to installing an oil filter in an automobile.) On the press-in style cap, tap it on until fully seated. Be careful to avoid damaging the cap while re-installing.

If the bearings need to be adjusted or replaced, the work should be done only by an authorized MasterCraft dealer. Failure to contact MasterCraft for preapproval during the warranty period will void the warranty.

The wheel bearings have been precisely torque-set at the factory. To assure the bearings are in good working order, check the bearing adjustment at least once a year by following this procedure:

- Jack up one side of the trailer. (Be certain to use jack stands and use chocks on each of the trailer wheels to keep the trailer from moving during the inspection.)
- Grip the edge of the tire and see if it can be rocked or moved. If the outer edge of the tire moves more than a small amount, the bearings may need to be readjusted.

A slight amount of oil seepage at the rear seal is normal and necessary to lubricate the wiper lip of the seal for long life and sealing contaminants out. If excessive leakage is occurring however, contact an authorized MasterCraft Dealer for assistance.

Trailers equipped with the UFP actuator will also be equipped with a Trailer Buddy Axle utilizing the VAULT bearing protector with

specially formulated Hybrid Oil™ lubricant. The VAULT combines the benefits of oil and grease, lubricating and protecting the wheel bearings in a sealed pressurized chamber impenetrable by outside elements.

The system has a number of unique features not found on conventional trailer axles. Every possible leak point on the front and rear of the hub is sealed. The slight (3-6 psi) pressure within the VAULT system generated inside the hub chamber will not damage the inner oil seals. The pressure inside the hub is needed to keep water out of the hub chamber when the hub is submerged underwater during launch and retrieval.

Inspection or replenishment of the lubricant is not required as part of the routine maintenance. At ambient temperatures the oil is thick, with a viscosity approaching grease. As the bearing temperature rises during towing, the oil thins out, replenishing the bearings with lubricant and dissipating heat. For optimal performance, only UFP's Hybrid Oil Lubricant should be used in this system.

Adding or changing the lubricant in the VAULT system is neither necessary nor recommended during the first five years of service. After that time, the maintenance requirements should be undertaken only by an authorized MasterCraft dealer and only the lubricant specified above should be used.

## Wheels

Trailer wheels and tires require more attention than the wheels on a family vehicle because they are regularly exposed to water. The three major items to check are: lug nuts, lubrication and tire pressure.

### **WARNING**

**Maintain the proper torque on the lug nuts attached to the wheel bolts. Failure to do so may result in serious injury or death and/or property damage. An authorized MasterCraft dealer can provide the proper torque specifications (measured in foot-pounds).**

### **WARNING**

**Keep the wheel bearings lubricated. Inspect the wheel bearings for proper lubrication before each use. Failure to do so may cause wheel failure and possible wheel loss, which may result in serious injury or death and/or property damage.**

Aluminum wheels also require attention to routine maintenance, particularly in keeping them clean. Failure to do so may result in damage that is not covered by warranty.

The trailer and wheels should be washed weekly during boating season, and after every use if the trailer has been submerged in salt or brackish water. Use a soft brush, mild detergent and/or mild degreaser. A quality spray-on wheel cleaner may also be used.



Ensure that any product used is specifically indicated for use on aluminum. (Many cleaners are too harsh and will result in pitting or other damage to the wheel surface.) Many car washes use strong chemicals and should be avoided when that is the case.

Removing road film, contaminants and brake dust (all of which retain moisture) is critical to ensuring that the wheels will retain their luster and quality finish for a long period of time. Any exposure to a harsh winter climate, particularly road salt and/or chemicals, or submersion in salt water at any time, requires immediate cleaning.

### **NEVER CLEAN WHEELS THAT ARE HOT.**

Allow wheels to cool or cool them with running water. If the wheels are too hot, significant damage can occur to the wheels.

## CAUTION

Wheels must always be cool or cold to the touch prior to cleaning. Failure to allow wheels to cool sufficiently can result in damage that is not covered under warranty.

It is also important to seal the wheels with a sealant that reduces static and resists brake dust. Check at an automotive supply store for an appropriate sealant.

## Lug Nuts or Wheel Bolts

Loose wheel mounting nuts (lug nuts) can cause more than just an annoying wheel wobble—it's possible to lose a wheel. Before each trip check for loose or missing lug nuts/wheel bolts.

## WARNING

Ensure that all lug nuts are secure prior towing a MasterCraft trailer. Failure to do so can cause a wheel to disengage from the hub. This can cause damage to the trailer that may not be covered under warranty. Serious injury or death to the driver, any passengers and/or other motorists can occur.

When tightening the lug nuts, use a correctly sized wrench. The wrong size can round off the lug nuts and render them useless. If you lose a lug nut, replace it promptly. The correct size varies with different models, so verify the proper size with an authorized MasterCraft dealer.



Take special care to ensure that the replacement lug nut is the correct type and size. While the threads of the v may match, the lug nut may be a size that does not hold the wheel securely against the hub, even when fully tightened. Be certain a replacement lug nut is an exact match for the original.

Ensuring that lug nuts on trailer wheels are tight and properly torqued is an important responsibility for maintaining your trailer in a safe operating condition. Inadequate and/or inappropriate lug nut torque (tightness) is a major reason that lug nuts can loosen during use. Loose lug nuts can rapidly lead to a wheel separation from the hub, with potentially serious safety consequences.

Check the lug nut tightness often, especially during the first few hundred miles of the trailer's use. You should always check the torque prior to beginning any long trip and every time a wheel is removed and reset.

You must use a torque wrench to accurately indicate the amount of torque that you are applying to the lug nut. Four-way wrenches,

ratchets, and similar tools can be useful for short-term emergency repairs but are not appropriate tools for accurately checking lug nut torque.

Keep a record of the date and approximate mileage when the lug nut torque is checked. Note any lug nut(s) that lost torque. Investigate the reason(s) if the lug nut torque is not maintained over more than one retightening because this can be indicative of a possible problem with the lug nuts, nut studs, wheels and/or hubs and that should be corrected.

Contact an authorized MasterCraft dealer immediately if any persistent lug nut loosening (or any other lug, wheel or axle problem) occurs.

In the event of a wheel separating from the trailer during use, notify an authorized MasterCraft dealer. Seek prompt professional assistance in assessing the trailer and its gear, and retain but do not reuse involved lug nuts, wheels and studs. Do not repair or service the trailer yourself. Instead, call a trained, authorized MasterCraft service technician.

Use the following pattern to tighten lug nuts. On first torquing pass tighten to 45 lb.-ft. On second pass tighten to 70 lb.-ft. On third pass tighten to 90 lb.-ft. On fourth pass tighten to a reading between 110 lb.-ft. and 120 lb.-ft. Follow the pattern shown in the photos on the next page.

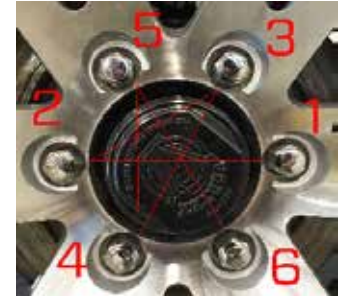

## TIRES

The most common cause of trailer tire trouble is under-inflation. It is important, to always maintain correct air pressure as indicated by the tire manufacturer on the tire's sidewalls. (Tire pressure information may be listed on stickers elsewhere as a convenience, but because tires may be replaced, the air pressure should always be verified on the tire's sidewall. If there is a difference between air pressure listings on labels, warning stickers and tire sidewalls, **always defer to the tire sidewall air pressure listing.**)

Always check the air pressure when the tires are cold. Tires heat up and the air pressure increases after traveling short distances. For safety and convenience, inflate tires to the air pressure indicated on the sidewall of the tire, but always carry a spare wheel and tire in case of unexpected or sudden issues with a tire.

When trailer tires become worn or damaged, replace them with new tires. An authorized MasterCraft dealer can help you.

During times of storage, maintain the proper tire inflation, shield tires from UV rays (direct sunlight), and relieve the load on the tires by supporting the trailer frame with concrete blocks or jack stands.



## **WARNING**

**Keep tires properly inflated. Inspect each tire's pressure before each use. Refer to the tire sidewall for proper inflation. Failure to maintain the correct tire pressure may result in tire failure and loss of control. This may result in serious injury or death and/or property damage.**

The tires that come equipped on the MasterCraft trailer were selected for durability as well as comfort and are matched to the trailer's specifications. Over time, as with all tires, there will be wear and eventually replacement will be necessary. At that time, do not mix radial and bias tires because it may affect the trailer/tow vehicle

handling and safety. MasterCraft dealers offer replacement tires; if the owner chooses to purchase tires elsewhere, be certain that the replacement tires meet the manufacturer's requirements and that they properly integrate with any tires remaining on the trailer.

## **Reading Tire Wear**

The way your tires wear is a good indicator of how your trailer's various systems are integrating. Abnormal wear patterns are often caused by the need for simple tire maintenance or alignment. Tires should be inspected at every opportunity. Learning to read the early warning signs of trouble can prevent wear that shortens tire life or indicates the need for having other parts of the trailer serviced.

### Tire Inspection Elements

- Visually inspect the tires
- Feel the tread by hand to detect tire wear such as feathering
- Check all tires with a tire pressure gauge

## **Samples of Abnormal Wear**

### **Overinflation**

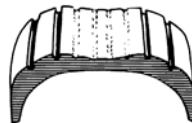

Excessive wear at the center of the tread indicates that the air pressure in the tire is consistently too high. The tire is riding on the center of the tread and wearing it prematurely. Many times, the "eyeball" method of inflation (pumping the tires up until there is no bulge at

the bottom) is at fault. Tire inflation pressure should always be checked with a reliable tire gauge. Occasionally, this wear pattern can result from extremely wide tires on narrow rims. In such situations, tires or wheels will have to be replaced.

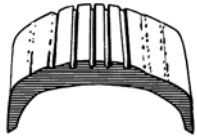

### **Underinflation**

This is the most common problem in trailer tires. This type of wear usually results from consistent underinflation. When a tire is under inflated, there is too much contact with the road by the outer treads, which wear prematurely. Tire pressure should be checked with a reliable pressure gauge.

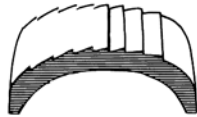

### **Feathering**

Feathering is a condition when the edge of each tread rib develops a slightly rounded edge on one side and a sharp edge on the other. By running your hand over the tire, you can usually feel the sharper edges before you'll be able to see them. The most common cause of feathering is incorrect toe-in setting. If this is occurring, have the toe-in adjusted to a proper setting.

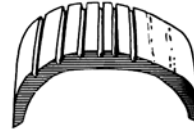

### **One side wear**

In instances where an inner or outer rib wears faster than the rest of the tire, there may be a need for a realignment of the tires. This occurs when there is excessive camber in the axle, causing the wheel to lean too much to the inside or outside and putting too much load on one side of the tire. The trailer may simply need the wheels aligned, but misalignment could be due to sagging springs, overloaded trailer or an unbalanced load on multi-axle trailers. Because load has a great effect on alignment, be sure the trailer is loaded to balance the weight on the axle or axles. Trailers should be towed with the trailer level, this is particularly important with independent suspension trailers using torsion axles.

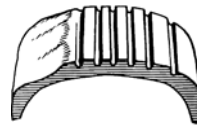

### **Cupping**

Cups or scalloped dips appearing around the edge of the tread on one side or the other almost always indicate worn (sometimes bent) suspension parts. Adjustment of wheel alignment alone will seldom cure the problem. Any worn component that connects the wheel to the trailer (wheel bearings, springs, bushings, etc.) can cause this condition. Worn components should be adjusted or replaced with new ones. The worn tire should be balanced



and possibly moved to a different location on the trailer. Occasionally, wheels that are out of balance will wear like this, but wheel imbalance usually shows up as bald spots between the outside edges and center of the tread.



### Second-Rib Wear

Second-rib wear is normally found only in radial tires, and appears where the steel belts end in relation to the tread. Normally, it can be kept to a minimum by paying careful attention to tire pressure and frequently rotating the tires. Some tire manufacturers consider a slight amount of wear at the second rib of a radial tire to be normal, but excessive amounts of wear indicate that the tires are too wide for the wheels. Be careful when having oversized tires installed on narrow wheels.

## BRAKING SYSTEM

Disc brakes offer several advantages over drum brakes. Disc brakes have improved resistance to fade on downhill grades. They are self-adjusting, so as the pads wear, braking efficiency

is not reduced. This type of brake recovers quickly after being submerged. They also require less maintenance, are easier to flush out, and are less susceptible to water-induced corrosion. MasterCraft uses two kinds of brakes. Surge brakes are standard and are designed to energize automatically when the tow vehicle's brakes are applied. Electric over hydraulic trailer breaks operate by electronically alerting the trailer breaks when the tow vehicle breaks have been activated.

**NOTE: Some jurisdictions do not allow surge brakes. Always check within the locality in which you will be towing.**

**NOTE: For information regarding optional electric over hydraulic brakes, consult the HydraStar Trailer Braking Systems manual included in your owner's packet.**

**Surge Brakes:** When the vehicle slows down or stops, the forward momentum (surge) of the trailer against the hitch ball develops hydraulic pressure in a master cylinder inside the trailer brake actuator. Hydraulic lines are used to transfer pressure to the brakes and engage them.

In most states, trailers with a Gross Vehicle Weight Rating (GVWR) of 1,500 lbs. or more are required to have brakes on all wheels. (Auto manufacturers recommend brakes even with lighter trailers.)



**Trailer brakes must be maintained in good working condition at all times. Have the brake system inspected by an authorized**

**MasterCraft dealer or service facility on a regular basis and verify proper fluid level in the actuator. The loss of adequate braking could result in serious injury or death and/or property damage.**

The trailer is equipped with a hydraulic brake actuator. Trailer brakes will automatically apply whenever the tow vehicle's brakes are applied. Stopping (deceleration) force is developed in direct proportion to the stopping force generated by the tow vehicle.

## **WARNING**

**The breakaway system actuators will apply the trailer brakes if the trailer becomes completely detached from the tow vehicle while under power. Failure to properly connect the breakaway system prior to towing may result in serious injury or death and/or property damage.**



The breakaway cable is an additional line of defense in the event the trailer becomes separated from the tow vehicle. Before the breakaway cable is pulled, the coupler must become detached from the hitch ball and the safety chains must fail. At this time the breakaway cable is pulled and applies a braking force to the trailer.

Note that the breakaway system is not intended to lock up the trailer brakes after separating from the tow vehicle but rather to apply just enough braking force to keep the trailer from free-wheeling. The breakaway system must be reset manually after it has been activated.

### **DO NOT USE THE BREAKAWAY SYSTEM AS A PARKING BRAKE!**

Surface rust may build up on the rotor brake surface if the trailer isn't used for a week or more. If this occurs, then generally the brake pads will wipe off the rust in the first few miles of travel. However, if the trailer has been idle for several months, or it has been frequently submerged in salt water and the brakes have not been flushed out (as described earlier in this section of Owner's Manual), severe corrosion can occur.

Try the brakes before each trip. On a regular basis, have the brake lines inspected, necessary adjustments made and any damaged or worn parts replaced by an authorized MasterCraft dealer.

Wet brakes have diminished braking capacity which necessarily means that wet breaks will not slow the trailer as quickly as under normal dry conditions. If the wheels have been in water, several brake applications at slow speeds should dry them out. If the wheel assemblies have been submerged in salt water, it is important to flush the rotors and calipers thoroughly with fresh water to minimize subsequent corrosion.

If the stopping capacity does not meet expectations, have the tow vehicle and the trailer brakes checked for proper operation. The trailer brakes should be inspected by an authorized MasterCraft dealer.

Review the tow vehicle manufacturer's recommendations and instructions for towing.

If the brakes are hot then before launching your boat, it is a good idea to allow the brakes to cool before submerging them. The sudden change in temperature when submerging very hot calipers and rotors stresses all the related parts and could cause damage.

If you are unable to back up, check the electronically operated back-up valve on the actuator, which is connected to the tow vehicle back up lights. When energized, the valve opens and prevents pressure build up in the system. When it is energized by shifting the tow vehicle into reverse, you should hear a noticeable "click" sound. If you don't, check that the electrical connection between the tow vehicle and the trailer is secure.

When parking the trailer, be sure the actuator is fully extended. This position relieves pressure on the brakes. Corrosion sometimes causes actuators to freeze in the compressed position. This causes the brakes to drag and overheat during subsequent outings.

## Recommended Brake Fluid

After only a year of use, used brake fluid in the typical marine trailer may contain as much as two percent (2%) water. Over time, the percentage will continue to grow and may reach as much as eight percent (8%). As the concentration of moisture increases, a sharp drop in the fluid's boiling point temperature results. As little as one percent (1%) moisture can lower the boiling point to 369°F/187°C.

According to DOT and OEM requirements, brand new DOT 3 brake fluid must have a dry (no moisture) boiling point of at least 401°F/205°C, and a wet (moisture saturated) boiling point of no less than 284°F/140°C. (Most far exceed these requirements, fresh out of the bottle.) Older brake fluid (about 18 months) with even three percent (3%) moisture content lowers the boiling point to 293°F/145°C, which is dangerously close to the minimum standard requirements.

Water contamination increases the danger of brake failure because vapor pockets can form if the fluid gets too hot. Vapor displaces fluid and is compressible, so when the brakes are applied, the actuator may completely compress without applying the brakes.

In addition, water laden brake fluid promotes corrosion and pitting in caliper pistons and bores, wheel cylinders, master cylinders, steel brake lines and reverse solenoids.



**Consumers must use only DOT 3—preferred—or DOT 4 brake fluid. DO NOT USE DOT 5 BRAKE FLUID. DOT 5 FLUID WILL DAMAGE THE SEALS IN THE ACTUATOR AND CALIPERS, CAUSING FAILURE OF BRAKES THAT COULD LEAD TO INJURY OR DEATH. Any other type may not provide sufficient chemistry to protect against overheating. Brake fluid should be completely replaced during annual maintenance (at least once every 12 months or more often if the system has shown evidence of brake fluid loss). Brake fluid types should never be mixed. Failure to provide required maintenance can cause brake failure, leading to incidents that result in serious injury or even death.**

DOT 5 brake fluid is a silicone-based fluid and requires specific materials for the boots, seals and wipers in the actuator master cylinder and caliper. Those materials are **NOT** used in MasterCraft trailers. Regardless of marketing claims made regarding a supposed superiority of DOT 5 brake fluid, the fact is, they will cause significant failures in the trailer's brakes because they are not designed to use DOT 5 brake fluid.

"Unexplained" brake failures are often traced to dragging brakes caused by the E-stop cable being tripped or the use of DOT 5 brake fluid. The underlying cause most often is because the brakes got over-heated and caused the fluid to boil. This can occur when the fluid level is appropriate, the linings are within specifications, and the hydraulics appear to work properly.

## **WARNING**

**DO NOT USE DOT 5 brake fluid in any component of MasterCraft trailers. The silicone causes seals to swell and can bind up caliper pistons. Do not use this in individual actuators, disc brakes or solenoids.**

The silicone in DOT 5 brake fluid also causes foaming bubbles when forced through small orifices under high pressure, such as the solenoid valves in a disc brake system. Bubbles in brake fluid result in spongy brakes. Silicone also tends to become slightly compressible at temperatures near its boiling point, which makes it generally inappropriate for trailers used in mountain conditions.

## **Brake Lockout**

When backing up, the coupler will move back and apply the trailer brakes. The brakes will apply at different levels depending on how fast you back up, the type of brakes, the road or surface, and the position/angle of the trailer. All MasterCraft trailers have an electrical solenoid control to allow the trailer to back up. This control is wired to the back-up lights on the tow vehicle, and when the tow vehicle is put into reverse, this control does not allow the trailer brakes to apply.

### **Manual Brake Lockout for the Actuator**



If the trailer needs to be moved while in reverse and without electrical connections to operate the reverse lock-out solenoid, the safety pin can be used to manually keep the coupler from applying pressure to the master cylinder. Place the pin in the hole at the front of the actuator housing. Remove the pin **IMMEDIATELY** after backing up and replace in the coupler position to lock the coupler.

Failure to do so will cause the loss of brake power when the trailer is towed.

## **WARNING**

The reverse lockout option must only be used when moving in reverse. Immediately remove the pin prior to towing and fully insert it into the coupler latch.

## Manual Bleeding of Brakes

### **WARNING**

The following procedure should be performed only by skilled mechanics. MasterCraft recommends that it be completed only by an authorized MasterCraft dealer.

Check that all hydraulic fittings are secure. Read and understand all instructions before starting. Two people are required for manual bleeding.

1. Remove the master cylinder reservoir cap and fill the reservoir with brake fluid. Use either DOT 3 (preferred) or DOT 4 automotive brake fluid. **DO NOT USE DOT 5 BRAKE FLUID. DOT 5 FLUID WILL DAMAGE THE SEALS IN THE ACTUATOR AND CALIPERS CAUSING FAILURE OF BRAKES THAT COULD LEAD TO INJURY OR DEATH.** (See recommended brake fluid information in this section of the Owner's Manual.)

2. Follow the instructions on the brake fluid container. Avoid shaking the brake fluid container, and pour fluid slowly to minimize air entrapment. Let the fluid in the reservoir stand until it is completely free of air bubbles.  
**IMPORTANT: Before bleeding the brake lines, bleed the actuator master cylinder. This is mainly required if a new master cylinder has been installed, or if the master cylinder was run dry or is low on fluid. To do so, remove the plastic access cover on the top of the actuator housing and insert a flat blade screwdriver between the rear bracket/tab and the fixed tab. The fixed tab is between the rear bracket/tab and the front (E-brake release) tab. While holding down the front tab, and using a slow/controlled motion, cycle the screwdriver fore-aft to pump the master cylinder push rod.**
3. Start the bleeding procedure on the brake farthest from the master cylinder.
4. At the brake assembly, connect a transparent bleeder hose to the bleed screw fitting on the caliper and submerge the free end into a container partially filled with brake fluid. Do not reuse this fluid.
5. The first person should stroke the push rod slowly while holding the safety release bracket down. The second person opens the bleed screw fitting. Then close the bleed screw fitting BEFORE the first person SLOWLY releases the push rod. Repeat this procedure until the fluid expelled from the bleeder hose is free of air bubbles. Remember to always tighten the bleeder screw before releasing the push rod. During this procedure, the master cylinder reservoir fluid level must be maintained at no less than half full.

6. Repeat Steps 4 and 5 for the other brake, as well as the brakes on the front axle of tandem axle trailers, or the center then finally the front on triple axle trailers. If installation is on a tandem-axle or triple-axle trailer, repeat the bleeding procedure on the rear axle(s) brakes for a second time to assure purging of all air in the system.
7. Push down on the safety release bracket to ensure that the push rod is in the released position.
8. After the bleeding is completed, recheck the fluid level in the master cylinder. Fill the master cylinder reservoir to 1/8" from the bottom of the threads on the reservoir cap. Do not overfill.
9. As a final check after bleeding is completed, stroke the push rod and check to be sure the brake system is pressurized. This is done by attempting to rotate a tire around. It is highly recommended to check the function of the brakes prior to running down the road. Attempt to back-up the trailer (preferably up and incline) without the wiring harness connected. This should activate the brakes to verify they are working as expected. If an incline is not available, and with the wiring harness disconnected, attempt to back-up the trailer against a wheel chock hard enough to slide the actuator rearward into the frame and engage the brakes. Remove the wheel chock and continue to back up to verify the brakes are engaging.



**Important: Do not use brake fluid drained from the brake system to refill the master cylinder reservoir as such fluids contain contaminants from the system that may result in brake failure or costly repairs.**

## Trailer Jack

MasterCraft recommends using the trailer jack to lift the coupling of a loaded trailer from the hitch ball. Rotate the trailer jack to the vertical position and engage the locking pin before placing a load on the trailer jack.

Like any mechanical assembly, the trailer jack requires maintenance to continue to function properly. The drive gear and the rack-and-pinion should be greased, and the caster and wheel bearings should be oiled frequently.

Failure to swing up the trailer jack and snap into towing position before towing may result in damage to the trailer.

To ensure the jack is locked in the up or down positions, there will be an audible "click" when the locking pin is fully engaged. Check that the jack is locked by trying to move the jack out of place.



## **WARNING**

Failure to engage the locking pin may result in the collapse of the jack stand, which could cause serious injury or death.

Always be certain that the feet of individuals operating the trailer jack or in the vicinity of the trailer jack are clear when the jack is lowered into position. A considerable amount of the trailer's weight, and that of the boat when it is aboard the trailer, can be transferred through the trailer jack. This could cause very painful injuries if feet are not clear of the jack when it is lowered. Be certain that fingers and hands are clear when moving the trailer jack because they can be pinched in the mechanism, again resulting in injury.

## **Tie Downs**

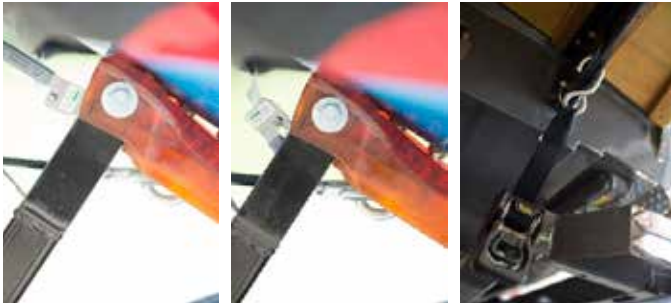

Ensuring that a MasterCraft boat will be held securely in place on the trailer's hull support (bunks), especially when towing, is extremely important. If the boat is not firmly and properly secured, the boat can be damaged as it bounces against the hull supports.

MasterCraft offers the Ramp-N-Clamp system to simplify loading and launching the boat from the trailer. To operate:

- Set the Ramp-N-Clamp handle to the down position so it can catch the boat when loading onto the trailer.
- Lift the Ramp-N-Clamp handle to the up position to release boat from the trailer.
- Do not lift the Ramp-N-Clamp handle until you are ready to release boat from the trailer.

## **Helpful Tips**

For easier release on the ramp, put the boat in forward gear or keep the winch strap tight while lifting the Ramp-N-Clamp handle.

Keeping the Ramp-N-Clamp cover and front of the boat waxed is part of the proper, regular maintenance.

If the boat rocks back and forth on the trailer while towing, raise the winch post uprights or add tie down straps to the trailer to prevent rocking. An ill-fitting trailer will cause wear that is not covered under the warranty.

A winch strap must be used and firmly tight while towing. This prevents wear to the bow eye that is not covered under warranty.

Also, it is very important to be sure that the transom of the MasterCraft boat is resting fully and securely on the supports provided at the rear end of the trailer, and that it remains in place when the trailer is parked or underway.

Tie-down eyes have been added on both the bow and transom of the boat and must be used while trailering. Buckles at the back of the trailer must also be secured to the boat prior to towing.

## Hitching Up

- Hitch only to the ball size marked on the coupler. All single and tandem axle trailers use a 2" ball, excluding the X24 and X26 tandem axle trailers. All triple axle trailers and the X24 and X26 tandem axle trailers use a 2-5/16" ball.
- Be certain that the ball clamp captures the ball.
- Cross the safety cables under the coupling.

Allow only enough slack in the safety cables to permit tight turns while towing. When hitching the trailer up, always observe each item on the Trailer Checklist found in this Owner's Manual. Hitching the trailer to the tow vehicle may be performed by just one person, but it is definitely easier with a second person to help guide.

## Trailer Hitching Steps

1. Slowly back the tow vehicle as close as possible to the trailer. It's easier—and safer—than pulling the trailer to the car or truck.
2. Check to be sure the coupler locking device is released.

3. Raise the front end of the trailer with the trailer jack, position the coupler directly over the hitch ball and lower the trailer with the trailer jack until it is all the way down onto the hitch ball.
4. Check under the coupling to be certain that the ball clamp is below the ball and not riding on top of the ball.
5. Lock the coupler to the hitch ball. To confirm that the coupler is locked onto the hitch ball, lift up on the trailer using the jack. If the trailer coupler comes loose from the hitch ball, unlock and go back to the third step above.
6. After the coupler is properly locked on to the hitch ball, be certain that the trailer jack is in the fully raised and locked position.
7. Attach the surge break-away cable to the tow vehicle, making sure there is enough slack for tight turns.
8. Attach the safety cables.
9. Connect the trailer's seven-wire connector to the seven-wire connector of the tow vehicle and check the operation of the trailer lights (break lights, turn signals, running lights).



# ADDITIONAL TRAILER OPTIONS

The MasterCraft Trailer supports a variety of optional features. The owner may customize their trailer by selecting any of these options during the initial phase of ordering. If you are curious about buying and installing one of these optional features after purchase, contact your authorized MasterCraft dealer in order to find out whether the desired option is retrofittable.

## Tire Pressure Monitoring System (TPMS)

The routine inspection of tire pressure status is essential to maintaining a safe, road-ready trailer. If your trailer has been outfitted with the Tire Pressure Monitoring System (TPMS), you can easily and conveniently monitor tire pressure status from the palm of your hand. The TPMS works by taking data from a sensor on the valve stem and transmitting that information via Bluetooth. This allows the user to read pressure levels from their smartphone, eliminating the hassles involved with manual inspection.

Installing the TPMS is a straightforward, intuitive process. The complete TPMS installation package resides in the boat's glovebox upon arrival. Retrieve the tire pressure sensors, attach them to the valve stems, and use the accompanying wrench to tighten as needed. Once you have installed the sensors, use your smartphone to download the In-Command TPMS app. Link your phone to the Bluetooth module and scan the QR-code on the back of the sensor. Selecting  will provide access to additional instructions from ASA Electronics, LLC, the app's developer.

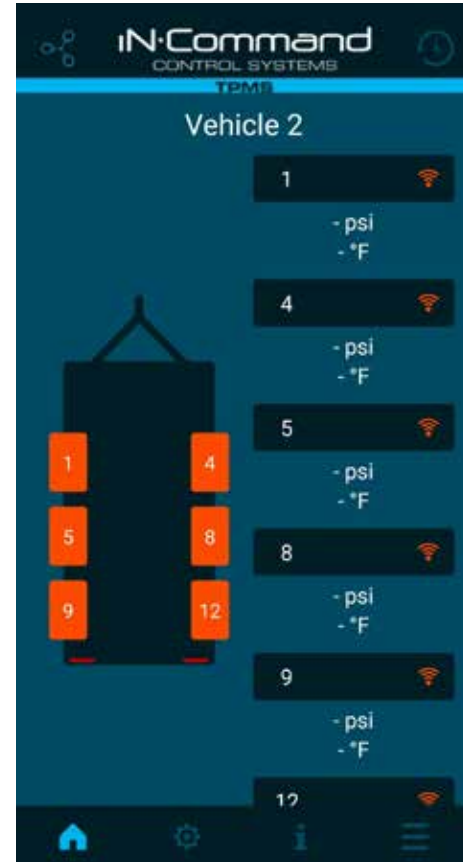

## Backup Camera System

Reversing a loaded trailer can sometimes be a tedious and time-consuming process, especially if no one else is present to direct your movements. The optional backup camera system addresses this problem by allowing you to reverse the trailer with the help of two rear-facing cameras. Equipped to the guide-poles on the back of the trailer, these cameras connect to a wi-fi module in the trailer harness, sending live footage directly to your smartphone. This simplifies trailer reversal and eliminates blindspots.

To activate and use the backup camera feature, simply download the Voyager Vision app and connect to the camera system via your phone's wi-fi settings. This will allow Voyager Vision to link up with the backup cameras and stream footage to your phone.



## Gatorbak Bunk Coating

If left unprotected, trailer bunks may induce wear on the hull of a boat. The Gatorbak option minimizes this threat by layering the bunk pieces with a heavy-duty rubber coat. This coat reacts more gently to the hull, thereby reducing the likelihood of damage.

## Transom Tie-Down Straps

To ensure a safe towing experience, customers are always encouraged to have two strong, taut connections running between the boat's transom and the trailer's rear. This guarantees additional stability and support when towing the boat.

The optional transom tie-down straps simplify the process of tying the transom to the trailer. The straps are already bolted to the trailer on arrival, sparing the hassle of manual tie-down installation. These pre-installed straps hook easily and intuitively to a pair of attachment points on the transom of the boat. A built-in ratchet is used to tighten the connection as needed.



## Electric over Hydraulic Brakes



As discussed earlier in this chapter, the MasterCraft Trailer may be equipped with an optional electric over hydraulic braking system. Unlike the standard surge brake system, this system utilizes an electrically-actuated hydraulic pump. When the operator applies the brakes in the towing vehicle, the trailer receives a signal to actuate the brake pump. In other words, the trailer brakes are controlled by the tow vehicle's braking system. This translates to quicker brake response timing. For additional information, refer to the HydraStar Braking System Manual in your boat's information packet.

## Galvanized Coat

The practice of coating metal with a protective zinc layer is known as galvanization. The zinc acts as a barrier between the metal and various corrosive elements in the atmosphere, continuing to protect the metal even after corrosion has started to wear away the zinc layer. As an optional feature, the MasterCraft Trailer can be strengthened with galvanic zinc to promote longevity and durability. The galvanized coat is available on all trailer models.

## Runway Lights



For purposes of secure operation, it is crucial that you maintain visibility when using the trailer in low-light conditions. Runway lights provide a helpful source of illumination in such conditions, offering an enhanced view of the trailer and surrounding area. This can eliminate risks involved with low-light operation.

Like the backup camera and TPMS features, the runway lights are controlled with an intuitive smartphone app. Using this app, you can easily adjust the intensity and brightness of the runway lights from the palm of your hand. The app also features infinite color selection, allowing you to adjust the hue of the runway lights.

To learn more about use instructions, app installation, infinite color selection, and other features, refer to the XKGlow Runway Lights Manual contained in your boat's information packet.

## Spare Tire



All models support an optional spare tire. Mounted to the front of the trailer, this feature serves as a convenient and reliable back-up tire in the event that one needs to be replaced. Make sure you keep the spare tire inflated and check it periodically. The tire's vin label should provide information on optimal pressure levels. For additional instructions, see the accompanying manual.

## Ramp-n-Clamp

As discussed earlier in this chapter, the MasterCraft Trailer supports an optional clamping tiedown for the bow. This optional feature, known as the Ramp-n-Clamp, simplifies the process of connecting the bow to the trailer.

The Ramp-n-Clamp is preinstalled on the MasterCraft Trailer. To use the Ramp-n-Clamp, set it to the down position before backing the boat onto the trailer. This will allow the boat to easily catch on the device. When you are ready to release the boat from the trailer, move the Ramp-n-Clamp to the up position. At any time, use the crank to fasten or loosen the strap as needed.

For additional information regarding the Ramp-n-Clamp feature, refer to the “Safety Cables” section of this chapter.



# TRAILER TIPS AND TECHNIQUES

When the MasterCraft trailer is loaded and in-tow, the combined dimensions of the trailer and boat are often greater than those of the tow vehicle itself. Bearing this in mind, the operator will need to make a few adjustments to their usual driving practices.

## Use Common Sense

MasterCraft cannot anticipate every type of situation in which drivers may find themselves. The following recommendations apply to general situations, but it is up to the individual driver to properly and safely act or react as a given situation requires.

## Take a Shakedown Cruise

Before making the first major trip or lake cruise with a MasterCraft trailer, make at least one short trial run to become familiar with its handling characteristics. Be sure everything is working properly

## Slow Down

There is less strain on the tow vehicle, trailer and boat at moderate to slow speeds. Also, many states have lower speed limits for vehicles towing trailers. Driving at moderate speeds will place less strain on the tow vehicle and the trailer. Trailer instability (sway) is more likely to occur as speed increases. Particular attention needs to be given to all aspects of towing when traveling over bumpy roads and railroad crossings.

## Allow Extra Time and Space

You'll need more of both when passing and stopping.

## Pass With Extra Care

Signal well in advance and make sure you allow extra distance to clear the vehicle you are passing before you pull back into the

lane. Pass on level terrain with plenty of clearance. Avoid passing on steep up or down grades. Down shift as necessary to improve acceleration or speed maintenance. When passing on narrow roads, be careful to avoid soft shoulders. Running on soft shoulders could cause the trailer to jack-knife or go out of control.

## Avoid Sudden Steering Maneuvers

These may create sway or undue side force on the trailer. To control swaying caused by air pressure changes and wind buffeting when larger vehicles pass from either direction, release the accelerator pedal to slow down. Keep a firm grip on the steering wheel.

## Allow Considerably More Distance for Stopping

There is considerably more weight to be maneuvered, and even though your trailer is equipped with a braking system, it is highly likely that additional room will be needed in order to execute slowing or full stops.

## Check the Rear View Mirrors

If not already equipped with them, install outside rear view mirrors on both sides of the tow vehicle. Make it a habit to check the mirrors at frequent intervals to be sure the trailer and boat are riding properly.

## Swing Wider

Trailer wheels are closer to the inside of turns than the wheels on the tow vehicle. This means swinging wider at curves and corners, will be required to prevent impacts between the trailer and other objects.

## **Do Not Control Trailer Sway by Using Vehicle Brakes**

Especially avoid jamming on the brakes hard. Generally, this type of action makes the sway worsen.

## **Pay Attention to Wind**

Be prepared for sudden changes in air pressure and/or wind buffeting when larger vehicles pass from either direction. Slow down a little and keep a firm hand on the steering wheel.

## **Do Not Tow With Z or ProStar Towers in the DOWN Position**

Towing a boat equipped with either the Z or ProStar tower in the UP position prevents premature wear. If the boat is equipped with a Bimini top, the top should be closed. If the tower has board racks, be sure that the board racks are folded to the inside.

## **Avoid Sudden Stops and Starts**

Even though the trailer has brakes, a sudden stop can cause it to skid, slide or even jack-knife. (Be especially careful to avoid the necessity for quick stops while turning.) Smooth, gradual starts and stops will improve gas mileage and put less strain on the tie-downs, etc.

## **Signal Your Intentions**

Well before stopping, turning, changing lanes or passing, use turn signals to let other vehicles know what you intend to do.

## **Drive in Tow Vehicle Manufacturer Recommended Gear**

If the tow vehicle has a manual transmission, traveling in lower gears when going up steep hills or over sand, gravel or dirt roads will ease the load on the engine and transmission. When driving on long downhill grades, try to avoid down-shifting. Running in a low gear going downhill, which uses the engine as a brake, can actuate the trailer's surge brakes continuously for the duration of the grade, causing them to over-heat. A better procedure is to slow down before the start of the down grade and maintain a controlled downhill speed with repeated application and release of tow vehicle (and thus, the trailer) brakes. This technique permits the brakes to cool down between applications and provides for reserve braking capacity in an emergency. On moderate and steep sections, down-shifting into lower gears may be unavoidable. Slowing down is important to allow the brakes to avoid overheating. Don't hesitate to pull over when possible during or after severe braking situations and allow the system to cool down. Running a stretch of highway where braking is not necessary is the quickest way to cool down the brake system because it allows a significant volume of air to flow through the vented rotors and over the brake pads.

## **Always be Courteous**

Make it as easy as possible for faster-moving vehicles to pass you. Remain in the slower lane and be prepared to reduce speed if they need extra time to return to the lane.

## Do Not Tailgate

Allow at least one combined car and trailer length between you and the car ahead for every 10 mph you are traveling.

## Bumping and Fish-Tailing Signals a Flat

Do not jam on the brakes or mash the accelerator to try to drive out of it. Stop slowly and in as straight a line as possible. If conditions permit, allow the trailer and tow vehicle to coast at a very slow speed and try to avoid braking, except when the wheels are straight ahead and the trailer and tow vehicle are in line.

If the trailer begins to fish-tail under acceleration to highway speed, back off the accelerator a little, and it should cease. If it begins again upon acceleration, stop and check the load. If the load is not evenly distributed, or if it is too far back so that the hitch load becomes too light, the result can be fish-tailing. Redistribute the load before continuing.

# LAUNCHING TIPS AND TECHNIQUES

Every MasterCraft boat owner develops his or her own favorite launching technique.

## Check The Ramp First

Whether launching from an unimproved or surfaced ramp, check it out before starting the launch procedure. How steep is it? Is the surface firm enough to support the weight of the trailer and tow vehicle? Is it wide enough? How deep is the water at the end of the ramp?



**Use great care when walking, standing or loading and unloading boats on or around any launch ramps because some launch ramps may be slippery when wet.**

Install the drain plugs and detach the trailer tie-downs.

# BACKING DOWN THE RAMP

If possible, have someone stand to one side of the ramp to provide directions. Backing up a trailer can be tricky. A good way to simplify the procedure is to grasp the steering wheel with one hand at its lowest point (6 o'clock). To make the trailer go right, move your hand on the wheel to the right (move the wheel counter-clockwise); to make the trailer go left, move your hand to the left (move the wheel clockwise). Slowly back the trailer into the water until the transom floats four (4) plus inches off of the trailer. The depth of the trailer to achieve this will vary depending on

ramp angle. Set the parking brake and shift into park (automatic transmission) or first gear (manual transmission). Shut off the engine. Unlock the Ramp-N-Clamp (where equipped) latch and winch hook; then back the boat off the trailer.

## RELOADING THE TRAILER

To reload the boat on the trailer, simply reverse the above procedures, including setting your Ramp-N-Clamp to the proper position, and drive the boat onto the trailer at an extremely slow pace. Before loading, clean any dirt or sand off the rollers and bunks. Sand on these can be abrasive on the boat's bottom while underway. Be sure to back in and completely wet the trailer bunks, then pull forward to the loading position. Be certain all the boat tie-downs are properly fastened down before departing from the launching ramp area.

## TRAILER DEPTH STICKERS

### Models

All NXT, XT, X and Star Series trailers, excluding the X26 trailer.

### Purpose

These stickers provide a visual indicator when loading and unloading a boat at various boat ramp angles. Some boat ramps have very flat launch angles and some ramps have very steep launch angles. Under different ramp conditions the trailer will need to be backed into the water deeper to minimize the collision between trailer bunks and a boat's hull bottom. Hard collisions can damage trailer bunks, trailer bunk carpet and the boat's hull bottom.

### Location

Trailer depth stickers are mounted to the guide poles on the trailer. Sticker height is model specific.

### Operation

Trailer depth stickers are labeled for three different boat ramp angles, STEEP, FLAT and NORMAL. On a STEEP ramp (12-15 degree ramp angle) the trailer should be backed in until the STEEP sticker is just below the water line. On a FLAT ramp (2-6 degree ramp angle) the trailer should be backed in until the FLAT sticker is just below the water line. On a NORMAL ramp (7-11 degree ramp angle) the trailer should be backed in until the NORMAL sticker is just below the water line.

**NOTE: These are recommended depths as measured under conditions at the factory-based lake. Adjustments may be necessary,**



**depending on load distribution in the boat as well as the angle of the ramp where the boat is being used.**

Power loading is always possible, but winching on the last few inches may be necessary, depending on the steepness of the ramp. As with most boats, if the trailer is backed in too far on a particularly steep ramp, the bow can easily go under the bow roller. Approaching the trailer very slowly (typically in neutral) is recommended.

Unloading depth can (and should be) somewhat deeper than these recommended loading depths, as the bunks are not needed to guide the boat off the trailer. Power unloading can burn the carpet in the same manner as power loading.



**Following loading, wet brakes may not hold and/or may cause brakes to have diminished performance characteristics. A few braking applications at a slow speed will help to dry them out. Extra care must be used when braking after brakes have become wet.**

## **Towing Requirements**

States and municipalities may require special permits and licenses based on the size and weight of your trailer. Some states require additional equipment for the tow vehicle, such as side and rear view mirrors. Inquire at your local motor vehicle administration office to find out what requirements affect you.

If you plan to travel in another state, don't forget to check requirements there also. In addition to licenses and permits, there may be weight, height and width limits for using certain roads, bridges and tunnels. Also, be aware of restrictions regarding the transport of gases or fuels in tunnels.

And don't forget to contact your insurance company to make sure you have proper coverage for all types of towing situations. Some jurisdictions may also require liability insurance. If you have a loan for the trailer purchase, your lender may also require insurance.

## **TRAILER CHECKLIST**

Before towing the vehicle, be sure to read and familiarize yourself with the instructions and warnings supplied with it.

### **Never Tow This Vehicle Before Safety Checking**

- Coupler, hitch and hitch ball are of the same size
- Breakaway cable is properly attached to the tow vehicle
- Coupler and safety chains are safely secured to the hitch of the tow vehicle
- All fasteners are properly tightened
- Boat is securely tied down to trailer (winch line is not a tie down)
- Wheel lug nuts are properly tightened

- Wheel bearings are properly adjusted and maintained
- Load is within the maximum load carrying capacity
- Load inside the boat is properly distributed
- Tires are properly inflated
- All trailer lighting is working properly
- Trailer brakes are properly adjusted and working (if trailer is so equipped).
- Tower on the boat (if so equipped) is secure. It is upright and locked in place, unless the tower can be locked in the down position.
- Sufficient overhead clearance before removing the boat/trailer from cover, or when towing so that the unit will clear any overhead items such as trees, bridges, overhead power lines, overpasses, etc.

This trailer is manufactured to meet the applicable federal safety standards at the time of manufacture. Check the local and state requirements regarding any additional equipment that may be required.

**NOTE:** Trailer laws covering such things as brakes, lights, safety cables, licenses, etc., will vary from state to state. Be sure that the trailer is in full compliance with applicable state laws. An authorized MasterCraft dealer can help in this regard. Otherwise, contact the nearest state motor vehicle department.

# MAINTENANCE

**NOTE:** Failure to follow these routine procedures may result in failures that are not covered under warranty.



**WARNING**

**Failure to follow maintenance procedures as outlined in this Owner's Manual may result in component failure. Such failure is not covered under warranty. Failure may also result in loss of control or other malfunction that could potentially lead to serious injury or death!**

Hose off the brake rotors and calipers, along with all other parts of the trailer that have come in contact with salt water or brackish water, as this will minimize corrosion. A fresh water flush of the system is the most critical aspect of trailer maintenance.

Extremely thick, heavy rust on rotor surfaces will not allow the wheel assembly to rotate freely, resulting in heat build-up and premature wear on components. Clean or replace components as necessary.

Brake pads must be replaced when  $3/32"$  (.094") or less of the pad friction material is left.



**WARNING**

**Brake pad replacement should be performed by an authorized MasterCraft dealer. Improper pad replacement may decrease**

**braking effectiveness, potentially resulting in a collision as a result of failure to stop the tow vehicle within an acceptable distance.**

Rotors should be resurfaced by a qualified brake specialist if extreme galling or wear marks are present.



## **WARNING**

**Worn rotors must be replaced. Failure to do so may result in brake failure, which may cause serious injury or death.**

Be certain that hydraulic fluid is clean and the fluid level is within 1/8" from the bottom of the threads on the reservoir plug. (See the Actuator and Axle information contained in this section of the Owner's Manual.) Do not fill beyond that level. Brake systems use DOT 3 (preferred) or DOT 4 hydraulic fluid.

**DO NOT USE DOT 5 BRAKE FLUID. DOT 5 FLUID WILL DAMAGE THE SEALS IN THE ACTUATOR AND CALIPERS, CAUSING FAILURE OF THE BRAKES THAT COULD LEAD TO INJURY OR DEATH.**

**NOTE: Care must be taken to avoid brake fluid coming in contact with the trailer paint. Brake fluid will damage paint! Such damage is not covered under warranty!**

Check for leaks in the brake lines and fittings. Leaks will lead to loss of trailer braking ability. Present the trailer to an authorized Master-Craft dealer for repair if lines or fittings appear to be leaking.

Aluminum wheels also require attention to routine maintenance,

particularly in keeping them clean. Failure to do so may result in damage that is not covered by warranty.

The trailer and wheels should be washed weekly during boating season, and after every use if the trailer has been submerged in salt or brackish water. Use a soft brush, mild detergent and/or mild degreaser. A quality spray-on wheel cleaner may also be used.

**Ensure that any product used is specifically indicated for use on aluminum** (many cleaners are too harsh and will result in pitting or other damage to the wheel surface). Many car washes use strong chemicals and should be avoided when that is the case. Removing road film, contaminants and brake dust (all of which retain moisture) is critical to ensuring that the wheels will retain their luster and quality finish for a long period of time. Any exposure to a hard winter climate, particularly road salt and/or chemicals, requires immediate cleaning the same as submersion in salt water.

### **NEVER CLEAN HOT WHEELS.**

Allow wheels to cool or cool them with running water. If the wheels are too hot, significant damage can occur to the wheels. **It is also important to seal the wheels with a sealant that reduces static and resists brake dust.** Check at an automotive supply store for an appropriate sealant.

## **Before Initial Use**

Read this entire Owner's Manual completely.

## Before Every Trip

- Ensure that all vehicle and trailer maintenance has been performed as set out in this Owner's Manual and the various other manuals, including the tow vehicle's owner's manual.
- Verify that the tongue weight and load are within proper specification. Further, be sure that the load distribution is correct so that the tow vehicle and trailer are properly balanced front-to-back and side-to-side.
- Check the brake fluid reservoir to ensure it has the proper fluid level.
- Examine the brake rotor surfaces and remove excessive rust, flushing the brakes if the trailer has been idle for an extended period of time or submerged in salt water and not flushed afterwards.
- Examine the actuator for wear, bent parts, corroded/seized parts or other damage.
- Test the actuator to verify the brakes are working prior to use.
- Verify all running lights and brake lights, turn signals and hazard lights, are working properly and that all wiring is properly connected. The wire harness must not be touching the road, but loose enough to make turns without disconnecting or damaging the wires.
- Verify the coupler latch and all equipment that connect the trailer and tow vehicle are properly secured and adjusted.
- Verify that there are no leaks in the hydraulic system.
- Verify the safety cables are properly attached to the tow vehicle.

- Verify the emergency brake cable is attached properly to the tow vehicle.
- Verify the boat is properly loaded on the trailer and properly tied down to the trailer.
- Verify and/or correct tire pressure on both the tow vehicle and trailer.
- Ensure the lug nuts are properly torqued. (This must also be done after the first 25 miles of towing and every 100 miles thereafter, at a minimum. MasterCraft recommends checking this more often. At each fuel or rest stop is not excessive.)
- Verify the wheel jack is retracted and in the locked position prior to towing.
- Verify the tow vehicle has not exceeded the load capacity prior to towing.
- Check the guide pole bars to ensure they are tight.
- Check that all items are securely fastened on and in the trailer.

## Every Three To Six Months Or 250 Miles, Whichever Occurs First (In Addition To Above)

- Grease the trailer jack.
- Oil the trailer jack handle in accordance with the manufacturer's recommendations.
- Examine the entire trailer for any abnormalities or damage.
- Examine the trailer bunks for any signs of abnormal wear.
- Lubricate all the rollers on the trailer with a light coat of oil.

## **Annually Or Every 2,000 Miles, Whichever Occurs First (In Addition To The Above)**

- To assure the bearings are in good working order, check the bearing adjustment at least once a year by following this procedure: Jack up one side of the trailer. (Be certain to use jack stands and chock the trailer wheels to keep the trailer from moving during the inspection.) Grip the edge of the tire and see if it can be rocked or moved. If the outer edge of the tire moves more than 1/8" at all, the bearings may need to be readjusted.
- Inspect the tow hitch for corrosion or damage. Repair or replace components as necessary.
- Check for wear on the hitch ball. If the ball is worn, it is UNSAFE and must be replaced.
- Check the coupler mechanism for smooth operation. If the latch handle does not spring open after being disengaged, lubricate the points on the coupler latch mechanism.
- Check the actuator for excessive wear. If the outer member is rubbing against the inner, wear marks will show on top of the coupler just forward of the outer member. Contact an authorized MasterCraft dealer for replacement parts.
- Check the actuator travel. Excessive actuator travel (over one inch) when the brakes are applied indicates air in the brake lines.
- Check the brake fluid in the master cylinder reservoir. On the actuator, remove the cap to the master cylinder reservoir by unscrewing the cap in a counter-clockwise direction. The brake fluid level should be 1/8" below the threads.
- Check for foam or bubbles in the brake fluid. If either is present, drain the fluid from the master cylinder and replace with ONLY new brake fluid of the same type (DOT 3 is preferred—or DOT 4). DO NOT USE DOT 5 FLUID. (See specific information in Recommended Brake Fluid in this section of this Owner's Manual.)
- In order for brakes to function properly, all air must be expelled from the brake system. If bleeding is necessary, have an authorized MasterCraft dealer perform this function or follow the manual bleeding of the brake system instructions as outlined in this Owner's Manual. It is imperative that the system be filled with only ONE type of brake fluid. Different types do not mix. Follow the instructions on the brake fluid container.
- Check the safety chains and attachment points for damage or wear. Repair or replace as necessary.
- Check the breakaway cable for worn or frayed cable strands. End fittings should be checked for damage. Replace as necessary.
- Check for any hydraulic leaks in the brake system. Be sure all tube fittings are tight. Periodic checks must be made on all hoses, brake line tubing and fittings to guard against cuts, worn hoses and loose fittings that may cause leaks in the trailer brake hydraulic system. Replace deteriorated and damaged parts as necessary.
- Check for chips and nicks in the paint. Touch up as necessary. Ignoring this will lead to accelerated wear and deterioration of the trailer.
- Check the condition of the bunks. If the coverings show wear, discuss with an authorized MasterCraft dealer. If the coverings are not in good condition or if the bunk sub-frame shows any damage,

this will adversely affect the fit of trailer to boat. This can result in damage to the boat hull, which is not covered under warranty.

## **Storage (For Several Months)**

- If at all possible, park the boat trailer in a protected, covered area such as a garage, carport or similar shelter. Keep all canvas covers on the boat while stored, but in higher humidity areas or periods of weather, it may be necessary to open a corner of the covered area to allow air circulation. See the Care and Maintenance section of this Owner's Manual for additional information and suggestions regarding storage procedures.
- Have the wheel bearings checked by an authorized MasterCraft dealer prior to reuse.
- Loosen the tie-downs and winch strap, but be sure the boat is still resting properly on the hull supports (bunks).
- Remove the drain plug and elevate the trailer tongue slightly (just an inch or two) to allow water to drain out so the boat will be dry. Tie the drain plugs from the boat's bilge system to something obvious such as the steering wheel so that they will be easy to remember to re-install before the next outing.
- A good time to touch up rust spots, nicks and chips is when the trailer is in storage.
- Replace damaged tie-downs, winch straps, wiring, etc.
- Maintain proper tire inflation.
- Shield tires from UV rays (direct sunlight).

- Relieve the load on the tires by supporting the trailer frame with concrete blocks or jack stands.
- Lubricate moving parts such as the rollers and winch, as well as the ball coupler.
- Tighten any loose nuts and bolts.

## **Extended Storage (In Excess of One Year)**

Follow the recommendations listed above for storage of several months duration. Additionally:

- Check the brake system for fluid level in the master cylinder. If the fluid level is low, air may be trapped in the brake lines. Bleed all lines if necessary and fill the reservoir to the proper level.
- Lubricate all links and pivots to prevent rusting.
- Fill the frame (to avoid damage from vermin).
- Be certain the breakaway system has not been set and that the actuator is fully extended.
- When possible, store away from excessive moisture.

# TROUBLESHOOTING

## WARNING

If any of the following problems develop, the trailer must be stopped and repaired immediately.

### Coupler Latch Handle Not Opening or Closing Easily

Possible Cause	Remedy
Ball not fully inserted in ball socket	Check for the proper ball size and positive tongue load. Check to see if the tongue jack is fully retracted. Make sure there are no foreign objects or excessive points inside the coupler cavity.
Trailer and tow vehicle not level with each other or facing downhill	Reposition the tow vehicle and trailer or block a trailer tire and extend the actuator.
Oversize hitch ball	Check ball size at several positions. The ball should be within 1.970"-2.000" in diameter. Replace if necessary.
Excessive corrosion	Lubricate or replace parts as necessary.
Ball clamp interference	Replace as needed, or lift the coupler slightly to enable the clamp to slide past the blockage, then let the coupler down.

## WARNING

If the latch handle does not close freely, DO NOT tow the trailer until locating and correcting the cause of the problem. Forcing the latch handle closed will make opening the latch handle extremely difficult.

### Squeaking, Clunking, and Clattering at the Actuator

Possible Cause	Remedy
The hitch ball requires lubrication	Lubricate with conventional multi-purpose lubricant or commercial lubricant made for hitch balls.
Loose hitch ball	Inspect the hitch ball and tighten.
Loose hitch	Inspect the hitch and repair.
A worn or too small hitch ball	Replace the hitch ball with a quality unit that meets SAE specifications.
Air in the brake lines, allowing the actuator to travel too far	Check for leaks and re-bleed the brakes.
Trailer equipped with "free backing" brakes	Clunking noise is typical for these types of brakes as long as braking performance is normal.

## When Braking, Brakes Repeatedly Come on and Release. Braking Is Not Smooth, Called “Chucking”

Possible Cause	Remedy
Loose hitch or ball	Correct as necessary.
Not enough tongue weight or shocks on tow vehicle too soft	Correct as necessary.
Air in the brake lines.	Bleed the brake lines.
Contaminated brake linings.	Fix the cause of the contamination, which will likely be a leaky wheel cylinder or hub grease seal. Replace the linings and clean the braking surface on the rotor.
Corroded master cylinder bore or rust from the brake line	Replace the actuator master cylinder.
Breakaway cable has been pulled	Reset the push rod release bracket.
Brake line kinked	Eliminate the kink. If found on a steel brake line, the line should be replaced.

## Brakes Not Operating or Performing Poorly

Possible Cause	Remedy
Worn out brake shoes or disc brake pads	Replace the brake shoes/pads on both sides of the axles and check the drums/rotors for wear or damage.
Foreign material in the brake unit assembly	Clean thoroughly. Replace the shoes and linings if contaminated.
Insufficient amount of hydraulic fluid.	Fill the reservoir and bleed the brakes. Check for leaks.
Broken lines or pinched line	Replace faulty lines and bleed the brakes.
Seized actuator master cylinder prevents piston from stroking	Replace actuator master cylinder.
Corrosion/rust keeps brake from operating	Replace damaged components or entire brake assembly as required.



## One Brake Is Overheating

Possible Cause	Remedy
Disc brake caliper does not permit the brake pads to release.	Check the caliper. Sections must be free to move apart. If frozen in place, remove and free it up. Caliper piston may freeze up and prevent pads from retracting. Clean contaminants out of the piston cavity. Replace the piston, seal and protective dust cover boot. Bleed the brake system.
Damaged or frozen brake mechanism	Rebuild or replace the brake unit.

## More Than One Brake Is Overheating

Isolate the problem to the actuator or the brakes by:

- Fully extend the actuator.
- Remove the master cylinder reservoir cap.
- Check that the reservoir is properly filled.
- Manually push the actuator inner member in or use a screwdriver to stroke the push rod.
- In the first 1/8" of stroke, the reservoir fluid will either remain completely calm or will swirl around. If the fluid swirls, then this indicates that fluid is being allowed to return to the reservoir when the actuator is extended. This means that the actuator is functioning properly and it is necessary to further troubleshoot the brakes to determine the cause of overheating.

- If the fluid is not disturbed, as described above, it means the brake system is remaining pressurized and there is a problem with the actuator. Troubleshoot the actuator to determine the cause of the problem.

## Potential Issues with the Actuator Include

- The fluid return hole in the master cylinder is clogged or is not correctly positioned
- Corrosion in the master cylinder is freezing the piston or not allowing it to fully retract, which is usually caused by a trailer being stored with the actuator compressed
- Some other malfunction or damage that is keeping the master cylinder from retracting.

Possible Cause	Remedy
Trailer has been stored with the actuator compressed and rust has caused the brakes to freeze up.	Remove the brakes. Clean, repair or replace the components as necessary. This is best done by an authorized MasterCraft dealer.
Pinched or kinked brake lines.	Check the brake lines and replace as necessary.
Pulled breakaway cable and the push rod has not been reset.	Reset the breakaway cable.

# BOAT TRAILER SPECIFICATIONS

LP = LOW PROFILE

ALL WEIGHT VALUES ARE LISTED IN LBS

## Single Axle Trailers

TRAILER	GVWR (GROSS VEHICLE WEIGHT RATING)	CAPACITY	FRAME SIZE	TRAILER WEIGHT	TIRE SIZE	GROSS COMBINED WEIGHT (BOAT ON TRAILER)
PROSTAR	5,660	4,530	4"	1,130	225/75R15 LRE	4,430
NXT20	5,660	4,565	4"	1,095	225/75R15 LRE	5,060

## Triple Axle Trailers

TRAILER	GVWR (GROSS VEHICLE WEIGHT RATING)	CAPACITY	FRAME SIZE	TRAILER WEIGHT	TIRE SIZE	GROSS COMBINED WEIGHT (BOAT ON TRAILER)
X24	10,000	8,165	5"	1,835	215/75R14 D	7,935
X24 LP	10,000	7,924	5"	2,076	255/55R18	8,176
XStar	10,000	8,250	5"	1,750	215/75R14 LRD	7,550
XStar LP	10,000	8,080	5"	1,920	255/55R18 XL	7,720
XT25	10,000	8,080	5"	1,920	215/75R14 LRD	7,120
XT25 LP	10,000	7,910	5"	2,090	255/45R18 XL	7,290
X26	10,000	8,110	5"	1,890	215/75R14 LRD	8,790
X26 LP	10,000	7,895	5"	2,105	255/55R18 XL	9,005

## Tandem Axle Trailers

TRAILER	GVWR (GROSS VEHICLE WEIGHT RATING)	CAPACITY	FRAME SIZE	TRAILER WEIGHT	TIRE SIZE	GROSS COMBINED WEIGHT (BOAT ON TRAILER, NO FUEL OR GEAR)
PROSTAR	7,014	5,699	4'	1,315	215/75R14 LRD	4,615
PROSTAR LP	7,014	5,589	4'	1,425	255/45R18 XL	4,725
XStar 2018+	8,258	6,458	5'	1,800	225/75R15 LRE	7,600
XStar LP 2018+	8,258	6,518	5'	1,740	255/55R18 XL	7,540
NXT20	7,014	5,739	4'	1,275	215/75R14 LRD	5,240
NXT20 LP	7,014	5,629	4'	1,385	255/45R18 XL	5,350
NXT22	7,014	5,614	5'	1,400	215/75R14 LRD	5,700
NXT22 LP	7,014	5,584	5'	1,430	255/45R18 XL	5,730
NXT24	7,498	6,128	5'	1,370	215/75R14 LRD	6,370
NXT24 LP	7,498	5,928	5'	1,570	255/55R18 XL	6,570
XT20	7,014	5,714	4'	1,300	215/75R14 LRD	5,800
XT20 LP	7,014	5,659	4'	1,355	255/45R18 XL	5,855
XT21	7,498	6,098	5'	1,400	215/75R14 LRD	6,200
XT21 LP	7,498	5,958	5'	1,540	255/55R18 XL	6,340
XT23	7,498	6,077	5'	1,421	215/75R14 LRD	6,671
XT23 LP	7,498	5,922	5'	1,576	255/55R18 XL	6,826
XT24	8,258	6,595	5'	1,663	225/75R15 LRE	7,213
XT24 LP	8,258	6,643	5'	1,615	255/55R18 XL	7,165
XT25	8,258	6,375	5'	1,883	225/75R15 LRE	7,083
XT25 LP	8,258	6,430	5'	1,828	255/55R18 XL	7,028
X22	8,258	6,646	5'	1,612	225/75R15 LRE	7,112
X22 LP	8,258	6,692	5'	1,566	255/55R18 XL	7,066
X24	10,000	8,080	5'	1,920	215/75R14 LRE	8,020
X26	10,000	8,115	5'	1,885	225/75R15 LRE	8,785

# LIMITED WARRANTY STATEMENT



# WARRANTY REGISTRATION AND TRANSFER

**1. Disclaimer and Limitation of Implied Warranties.** The express limited warranty set forth herein (this “*Warranty*”, “*Limited Warranty*” or the “*Limited Warranty Statement*”) is in lieu of all other warranties and representations, express or implied, and to the maximum extent permitted by applicable law, MasterCraft disclaims, and the Purchaser (as defined in Section 2) hereby expressly waives, any and all other warranties or representations of any kind or nature, including, but not limited to, implied warranties of merchantability and fitness for a particular purpose, other than those warranties which are implied by, and are incapable of exclusion, restriction or modification under applicable law. The term of any implied warranties that cannot be disclaimed under applicable law, including, but not limited to, implied warranties of merchantability and fitness for a particular purpose, shall be limited to the duration of the express warranty periods applicable to the respective components. Some states do not allow the exclusion of implied warranties and/or do not allow limitations on the amount of time an implied warranty lasts, so the above limitations may not apply to you. This Limited Warranty gives you specific legal rights. You may have other rights which vary from state to state.

**2. Limited Warranty and Term.** MasterCraft Boat Company, LLC. (“MasterCraft”) warrants to the original retail purchaser (the “*Purchaser*” or “*You*”) that the following components of each new and unused boat manufactured by MasterCraft shall be free from material defects in materials and workmanship to the extent set forth in this warranty, under normal use and when operated and maintained in accordance with MasterCraft’s instructions, beginning on

the In-Service Date defined in section 2.6 of this Limited Warranty Statement, for the period(s) indicated in this Section 2:

**2.1 Deck, Hull, Liner and Stringers.** The deck, hull, liner and stringer system (collectively, the “Structural Components”) are warranted for as long as the original purchaser owns the boat.

**2.2 Gel Coat.** Provided that you have provided proper maintenance and care as described in the Corrosion and Cleaning the Boat sections of the MasterCraft Owner’s Manual, the gel coat, which is applied to all MasterCraft boats at the factory, will be warranted for a period of one (1) year from the In-Service Date for stress crazing of the gel coat. However, no warranty is provided and MasterCraft expressly disclaims any warranty for scratching, discoloration or fading of the gel coat. The reason for this limitation and exclusion is because environmental operating conditions and customer maintenance/care are factors that have a significant effect on the condition and durability of the gel coat and are factors that are outside of MasterCraft’s reasonable control.

**2.3 Engine.** The Ibmor engine of your MasterCraft boat has a warranty period of seven (7) years from the In-Service Date or the attainment of 1000 hours of engine operation, whichever occurs first.

**2.4 Screens.** All electrical display screens on the instrument panel of the boat have a warranty period of three (3) years from the In-Service Date or the attainment of 600 hours of engine operation, whichever occurs first.

**2.5 SeaDek Flooring & Pads.** All decking and platform components manufactured by Hyperform, INC. d/b/a SeaDek Marine Products (“SeaDek”) and installed by MasterCraft at its factory are warranted for a period of two (2) years from the In-Service Date or the attainment of 600 hours of engine operation, whichever occurs first. This limited warranty does not apply to decking and platform components manufactured by SeaDek that are not installed by MasterCraft at its factory (i.e., it does not apply to aftermarket components installed by a dealer or by Purchaser after MasterCraft’s production of the boat)(collectively, “Aftermarket SeaDek Products”). Any warranty for Aftermarket SeaDek Products shall be governed by the applicable warranty issued by SeaDek, if any.

**2.6 Other Component Parts.** All other components of the boat not specifically referenced in Sections 2.1 through 2.5 hereof are warranted for a period of five (5) years from the In-Service Date.

**2.7 Trailer and Trailer Component Parts.** All components are warranted for a period of five (5) years, with the exception of the trailer’s paint, which is warranted for a period of one (1) year, from the In-Service Date.

**2.8 Warranty Period.** All express warranties are for the applicable time periods set forth in this Section 2, unless a longer warranty period is required by applicable law, in which case such longer warranty period will apply. MasterCraft’s boats and trailers are manufactured by MasterCraft in model years which run from July 1 of a given year through June 30 of the immediately following year (a “*Model Year*”). The start date for the warranty periods shall be deemed to

be the earlier of the date of the original retail purchase of the new and unused boat or trailer from an authorized MasterCraft dealer, as applicable, or the date that the boat or trailer was first used by Purchaser, whichever first occurs (the “*In-Service Date*”). The manufacturers of certain components of your MasterCraft boat warrant their product for periods exceeding the time limits stated in this Limited Warranty Statement. MasterCraft administers this Warranty within the limits specified in this Limited Warranty Statement only, but will provide contact information to you from component manufacturers in applicable circumstances upon your request.

**3. Warranty Conditions, Limitations and Exclusions.** MasterCraft boats are manufactured by trained crafts-persons from high-quality materials and components. However, conditions outside of MasterCraft’s control require specific limitations on, and exclusions from, coverage under this Warranty. The Warranty on the Structural Components set forth in Section 2 of this Warranty does not cover or include any other components fastened or applied to the hull or deck. This Limited Warranty constitutes the final, complete and exclusive statement of warranty terms, and no other person or entity is authorized to make any other warranties or representations on behalf of MasterCraft. Furthermore, the warranty set forth in Section 2 (including all subsections) of this Limited Warranty Statement does **NOT** cover any of the following, each of which are expressly excluded from warranty coverage:

- Damage caused by misuse, negligence, accident, collision or impact with any object;



- Damage caused by any improper alteration or modification to the boat or trailer or any of its component parts or accessories, including damage resulting from alteration, modification, repair or replacement in such a way as to increase the cubic-inch capacity or horsepower output of the engine and boat as originally manufactured;
- Damage caused by the use of improper or contaminated fuel or fluids;
- Damage caused by the use of customer-applied chemicals or accidental spills;
- Damage caused by failure to maintain the boat in accordance with the maintenance provisions in the Owner's Manual or improper maintenance or repairs to the boat, by a service facility, Purchaser or any other person or entity;
- Damage caused by the failure to comply with any recall or request for repair as directed by MasterCraft;
- Damage resulting from the use of the boat for any racing, speed, commercial competition or performance demonstration;
- Damage resulting from use of the boat for rental, commercial or industrial purposes;
- Damage to hardware and other components fastened or adhered to the hull, deck or liner;
- Damage caused by fire, theft, freezing, vandalism, explosion, lightning, wind, hail storms, flooding or any other type of natural disaster or weather;
- Damage caused by use of any non-MasterCraft trailer to transport, move or store the boat;
- Damage caused by improper support of the boat on davits, a hoist system or boat lift of any kind;
- Damage to paints, varnishes, gel coat surfaces and colors, chrome-plated or anodized finishes, floor and floor covers and any other surface coatings, as well as damage due to in-water storage without proper barrier coat and bottom paints. (Note: although MasterCraft uses the highest grade gel coat materials, a condition may develop where the bottom of the boat may show signs of discoloration and/or blisters if the boat is left in the water for long periods of time, i.e., in excess of thirty (30) days. Therefore, a proper barrier coat and bottom paint should be used whenever it is anticipated that the boat will be left in the water for an extended period of time, i.e., in excess of thirty (30) days);
- Damage to the trailer and its parts or components due to abrasions, rock chips, rust, improper care or maintenance, or use in salt or brackish water;
- Damage caused by dealer-installed options or accessories;
- Standard maintenance items that wear with use and must be periodically replaced or replenished, including but not limited to:
  1. Battery(ies);
  2. Light bulbs;
  3. Fuses;
  4. Spark plugs;
  5. Spark plug wires;
  6. Fuel filter;
  7. Air filter;
  8. Oil filter;
  9. Engine oil;
  10. Transmission fluid;
  11. Engine belts;
  12. Antifreeze;
  13. Raw water impeller;
  14. Ballast impellers;

15. Trailer brake pads and rotors;
16. Trailer tires and wheels;
17. Trailer brake fluid;
18. Trailer bunk carpet;
19. Anodes (on transom, shaft, attitude adjustment plate and WSD's);
20. Gaskets, foam and padding; and
21. Trailer bow rollers

#### **4. Commercial Boats, Special Use and Demo Boat Warranty Conditions, Limitations and Exclusions.**

##### **4.1 Commercial Boats**

**4.1.1 Definition** For purposes of this warranty, a Commercial Boat is defined as “a boat that is used to generate income of any kind, whether direct or indirect.” Examples of commercial use boats include those used in ski schools, ski clubs, ski camps, rental boats, boat clubs, or resort-use.

**4.1.2 Warranty Conditions, Limitations and Exclusions** In addition to the warranty conditions, limitations and exclusions, set forth in Section 3 of this Limited Warranty, all of which apply to Commercial Boats, the following additional warranty limitations apply to Commercial Boats:

- a. For a period of ninety (90) days from the In-Service Date, MasterCraft will provide full warranty coverage in accordance with the terms and conditions of this Limited Warranty Statement.
- b. Between ninety-one (91) days from the In-Service Date and the attainment of 500 hours of engine operation there is no warranty for gel coat, upholstery, cosmetic flaws, or any other component except components of the boat's engine and transmission.

c. After the attainment of 500 hours of engine operation, any and all warranty coverage under this Limited Warranty Statement shall expire and be of no further force or effect.

d. Upon sale of the boat to a second owner, all warranty coverage under this Limited Warranty Statement shall expire and be of no further force or effect.

##### **4.2 Special Use Boats**

**4.2.1 Definition** For purposes of this Warranty, a Special Use Boat is defined as “a boat that is used under consignment, as a photo, athlete, and/or engineering design validation boat.”

**4.2.2 Warranty Conditions, Limitations and Exclusions** In addition to the warranty conditions, limitations and exclusions, set forth in Section 3 of this Warranty, all of which apply to Special Use Boats, the following additional warranty limitations apply to Special Use Boats:

- a. From the date the boat is invoiced by MasterCraft, the warranty coverage for the original retail Purchaser will extend for a minimum of ninety (90) days. The warranty coverage will be as stated in Subsection (b) of Section 4.1.2 and will continue until the attainment of 500 hours of engine operation or for a period of ninety (90) days from the date of the invoice, whichever is greater, after which all warranty coverage under this Limited Warranty Statement shall expire and be of no further force or effect.
- b. There is no warranty coverage for a subsequent owner of the boat regardless of the period of time or the number of engine hours.

##### **4.3 Demo Boats**

**4.3.1 Definition** For purposes of this Warranty, a Demo Boat is de-

fined as “any boat that has reached fifty (50) hours or engine usage before retail sale to a consumer.”

**4.3.2 Warranty Conditions, Limitations and Exclusions** In addition to the warranty conditions, limitations and exclusions, set forth in Section 3 of this Warranty, all of which apply to Demo Boats, the following additional warranty limitations apply to Demo Boats:

- a. Beginning with the earlier of the date of the original invoice for the boat from MasterCraft to the authorized MasterCraft dealer or the date the boat was first used by the dealer for demonstration purposes, whichever first occurs, the boat will have full warranty coverage under the terms and conditions of this Limited Warranty Statement for the periods specified in Section 2 of this Warranty.
- b. Upon sale of the boat to a second owner, the warranty coverage may be transferred to the second owner in accordance with the provisions of Section 6 of this Limited Warranty Statement.

## 5. Limitation of Liability

**5.1 Liability Limitation - Exclusion of Consequential Damages.** This Limited Warranty is for the benefit of the Purchaser and MasterCraft, and shall not create or evidence any right in any third party. The repair or replacement of any component parts as provided under this Warranty is the exclusive remedy of the Purchaser. The decision regarding whether a part or component should be repaired or replaced will be made by the applicable MasterCraft authorized servicing dealer and/or MasterCraft. To the maximum extent permitted by applicable law, in no event shall MasterCraft be liable for any incidental, consequential, special, indirect, punitive or exemplary damages or lost profits whatsoever arising out of the use

or inability to use the boat or any component part thereof, or for any breach of this limited warranty or otherwise, even if MasterCraft has been advised of the possibility of such damages or such damages could reasonably have been foreseen by MasterCraft. However, some states do not allow the exclusion or limitation of incidental or consequential damages, so the above limitation or exclusion may not apply to you.

**5.2 Purchase Price Limitation.** In any event, MasterCraft’s entire liability under any provision of this Limited Warranty shall be limited to the repair or replacement of the boat, trailer or component part, or the refund of the purchase price paid by the consumer for the boat, trailer or component part found to be defective within the applicable warranty period. This shall constitute MasterCraft’s sole liability and obligation in the event of any claim arising out of its performance or nonperformance of any provision of this Limited Warranty. Because some states and jurisdictions do not allow the exclusion or limitation of liability, the above limitations may not apply to you.

**6. Transfer of Limited Warranty.** Subject to the provisions of Section 4 and this Section 6 of this Warranty, upon the first sale, conveyance or other transfer of the boat or trailer by the original retail Purchaser, any remaining unexpired Warranty coverage shall be transferred to the second owner and shall remain in effect for the remainder of the applicable warranty period(s) set forth in Sections 2.1 through 2.7 hereof (which warranty periods begin to run in accordance with Section 2.8 or Section 4 hereof, as applicable), upon delivery of the warranty transfer card and payment of the applicable warranty transfer fee to MasterCraft. With respect to the Lifetime

Limited Warranty (granted only to the original retail Purchaser) on the Structural Components set forth in Section 2.1 hereof, if: (a) the sale, conveyance or other transfer of the boat by the original retail purchaser to another person or entity occurs within five (5) years of the date of the original retail purchase of the boat by the original retail purchaser; AND (b) the original retail purchaser and the second owner comply with the provisions of this Section 5, then the limited warranty on the Structural Components shall be transferred to the second owner and shall continue in effect for a period of ten (10) years from the date of the original retail purchase of the boat by the original retail Purchaser. If the sale, transfer or conveyance of the boat by the original retail purchaser occurs more than five (5) years after the date of the original retail purchase of the boat, then the Limited Warranty on Structural Components (as well as all other warranties) shall be void as of the date of transfer and shall not be transferable to the second owner.

Only one (1) transfer of the Limited Warranty under the provisions of this Section 6 (from the original retail Purchaser to the second owner), within the applicable time period, may be made. In the event of a sale or transfer of the boat and/or trailer by a second owner to a subsequent purchaser, all coverage under this Limited Warranty shall immediately be terminated and the Limited Warranty shall immediately become null and void. No transfer of this Warranty will operate to extend any of the warranty periods set forth in Sections 2 or 4 hereof. In order to effectuate the transfer of the Limited Warranty, the original retail purchaser and the new owner must properly fill out the warranty transfer card found in the back of the Owner's

Manual and deliver the completed card, together with a check made payable to "MasterCraft Boat Company, LLC," in the amount of the warranty transfer fee, via U.S. Mail, postage prepaid, to MasterCraft at the address shown on the warranty transfer card. The card and check for the warranty transfer must be post-marked within the time period specified above in this Section 6 in order for the warranty transfer from the original retail purchaser to the second owner to be effective. **In order to complete the transfer, the second owner must transport the boat and trailer (if equipped) to an authorized MasterCraft Dealer for the completion of an inspection to be documented and submitted to MasterCraft by the authorized dealer.** The inspection is to be completed at the cost dictated by the MasterCraft Dealer. This cost is the responsibility of the new owner. **Note:** The new purchaser must also pay a separate fee for engine transfer. See Ilmor Marine's Owner's Manual.

**7. Warranty Claims.** In order to maintain warranty service under this Warranty, the Purchaser must return the defective boat or component part to an authorized MasterCraft dealer's service department, or to MasterCraft's factory at the below address, within the applicable warranty period. For questions regarding warranty service or to obtain information regarding warranty service or to obtain information regarding the nearest authorized MasterCraft Dealer, please contact MasterCraft at the following address or telephone number:

MasterCraft Boat Company, LLC  
Attention: Warranty/Customer Service  
100 Cherokee Cove Drive  
Vonore, Tennessee 37885  
1-423-884-2221

Subject to the terms of this Limited Warranty, any covered boat or component part with a material defect in materials or workmanship that is returned to an authorized MasterCraft Dealer's service department or MasterCraft's factory during the appropriate warranty period will be repaired or replaced, in MasterCraft's sole discretion, without charge to the owner for parts and labor. This provision is subject to the following terms and conditions:

- MasterCraft shall be obligated only to repair or replace those items that prove defective, in MasterCraft's sole discretion, upon examination by a MasterCraft authorized Dealer's service department or MasterCraft's own personnel, as applicable;
- MasterCraft warrants its repairs or replacements only for the remainder of the applicable warranty period under the terms of this Warranty;
- MasterCraft shall, in its sole discretion, fulfill its obligation to repair or replace any defective item at its factory or its authorized Dealer's service department; and
- The Purchaser shall be responsible for all costs associated with the transportation of the boat, towing bills, trailer or component part(s) to the authorized MasterCraft service department and for any return transportation.

**8. No Modification of Warranty.** No oral or written information, advice or communication of any nature to or from MasterCraft or its representatives, employees, authorized dealers, agents, distributors or suppliers shall create a warranty or in any manner increase or modify the scope of this Limited Warranty in any manner whatsoever.

# WARRANTY REGISTRATION AND TRANSFER

## Warranty Registration

At the time of delivery to the first retail Purchaser of a MasterCraft boat, the boat must be registered for product warranty purposes under applicable federal and state law, and the following steps must be performed in order to complete the warranty registration process for all MasterCraft boats:

- At the time, and on the date, of delivery to the retail Purchaser, the dealer must complete the warranty registration for the boat Purchaser using MasterCraft's online warranty registration system found on the DealerLink system.
- Dealer must notify MasterCraft of a boat sale via DealerLink and shall submit for the Purchaser all required information in connection with the warranty registration for the boat and trailer.
- Warranty registration is essential because it provides a method for distributing information to MasterCraft boat owners and allows MasterCraft to notify the Purchaser of any mandatory recalls or other issues requiring attention.

## Warranty Transfer

In accordance with the provisions of Section 6 of the MasterCraft Limited Warranty Statement (the "*Warranty*"), if the MasterCraft boat is subsequently sold by the original retail Purchaser, MasterCraft offers a transferable warranty to the second owner of any re-

maining unexpired warranty coverage under the Limited Warranty (see also the provisions regarding certain boats described in Section 4 of the Warranty). In accordance with the Limited Warranty, with respect to the Lifetime Limited Warranty (which is granted only to the original retail purchaser) on the Structural Components (deck, hull, liner and stringer system) set forth in Section 2.1 of the Limited Warranty, if:

**a.** The sale of the boat by the original retail Purchaser occurs within five (5) years of the date of the original retail purchase of the boat by Purchaser; AND

**b.** The original retail Purchaser and the second owner comply with the provisions of Section 6 of the Warranty; then the warranty on the Structural Components of the boat shall be transferred to the second owner and shall continue in effect for a period of ten (10) years from the date of the original retail purchase of the boat by the original retail purchaser. In order to complete the transfer of any remaining warranty under the Warranty by the original retail Purchaser to the second owner, the second owner must deliver each of the following to an authorized MasterCraft dealer within fourteen (14) days of the date of the sale by the original retail Purchaser to the second owner (and within five (5) years of the date of the original retail purchase of the boat with respect to the transfer of the warranty on the Structural Components):

- Copy of Sales Agreement/Invoice

- Payment of \$500
- MasterCraft dealer to provide copy of inspection report to MasterCraft Boat Company as part of transfer

Upon MasterCraft's receipt of the dealer's inspection report, any remaining warranty coverage under the Warranty will be transferred to the second owner, with all warranty coverage periods running from the applicable date for the beginning of the warranty period as described in Section 2.6 or Section 4 (as applicable) of the Warranty. **Note:** The second purchaser must also pay a separate fee for engine transfer. See Ilmor Marine's Engine Owner's Manual for more information on engine warranty transfer procedure.

# ADDITIONAL WARRANTY STATEMENTS

The following warranty statement is provided by MasterCraft Boat Company, LLC (“*MasterCraft*”) only to owners of MasterCraft spark engine marine watercraft who reside, or operate their MasterCraft boat, in California, and is being provided pursuant to applicable regulations adopted by the California Air Resources Board:

## CALIFORNIA EVAPORATIVE EMISSIONS CONTROL SYSTEM WARRANTY STATEMENT

### Your Warranty Rights and Obligations:

The California Air Resources Board and MasterCraft Boat Company are pleased to explain the evaporative emission control system’s warranty on your MY 2022 spark-ignition marine watercraft. In California, new spark-ignition marine watercraft must be designed, built, and equipped to meet the State’s stringent anti-smog standards. MasterCraft Boat Company must warrant the evaporative emission control system on your spark ignition marine

watercraft for the period listed below provided there has been no abuse, neglect or improper maintenance of your spark-ignition marine watercraft.

Your evaporative emission control system may include parts such as: carburetors, fuel tanks, fuel lines, fuel caps, valves, canisters, filters, vapor hoses, clamps, connectors, and other associated evaporative emissions control system components.

### Manufacturer’s Warranty Coverage:

This evaporative emission control system is warranted for five years. If any evaporative emission-related part on your spark-ignition marine watercraft is defective, the part will be repaired or replaced by MasterCraft Boat Company.

### Owner’s Warranty Responsibilities:

- As the spark ignition marine watercraft owner, you are responsible for performance of the required maintenance listed in your owner’s manual. MasterCraft Boat Company recommends that you retain all receipts covering maintenance on your boat, but MasterCraft Boat Company cannot deny warranty solely for the lack of receipts.
- As the boat owner, you should however be aware that MasterCraft Boat Company may deny you warranty coverage if your spark-ignition marine watercraft or a part has failed due to abuse, neglect, or improper maintenance or unapproved modifications.
- You are responsible for presenting your spark-ignition marine

watercraft to a MasterCraft Boat Company dealership sales or service center as soon as the problem exists. The warranty repairs should be completed in a reasonable amount of time, not to exceed 30 days. If you have a question regarding your warranty coverage, you should contact your local MasterCraft dealer or MasterCraft Boat Company at 1-423-884-2221.

**Applicable SIMW evaporative emissions warranty parts list  
pursuant to 13 CCR §2861(e):**

1. Canister Mounting Brackets
2. Carbon Canister
3. Clamps\*
4. Fuel Cap
5. Fuel Lines
6. Fuel Line Fittings
7. Fuel Tank
8. Vapor Hoses
9. All other parts not listed that may affect the evaporative emissions control system

\*Note: As they relate to the evaporative emissions control system.

**NMC-2017-015**





# SERVICE LOG



# SERVICE LOG - BOAT

As Needed	Date	Date	Date	Date	Date
-----------	------	------	------	------	------

Replace raw water impeller

---

Replace ballast impeller(s)

---

Add/change oil filter

## Every 50 Hours

Lubricate starter gear and shaft

---

Change engine oil and filter

---

Check all safety equipment

## Every 100 Hours

Replace impeller

---

Engine tune-up

Every 100 hours	Date	Date	Date	Date	Date
Change transmission fluid					
Check engine mounts					
Check prop shaft coupling alignments					
Inspect exhaust flaps					
Lubricate steering system					
Lubricate shift and throttle system					
Check/replace ballast pump impeller					
Inspect complete fuel system					
Change fuel filter					
Perform engine/drive train service					

# SERVICE LOG - TRAILER

3-6 Months/250 miles

Date

Date

Date

Date

Date

Grease trailer jack

---

Oil trailer jack handle

---

Examine entire trailer for damage or wear

---

Lubricate Rollers

Annually/Every 2,000 miles

Check bearing adjustment

---

Inspect tow hitch

---

Check for hitch ball wear

---

Check coupler mechanism

---

Check actuator for wear and travel

Annually/Every 2,000 miles	Date	Date	Date	Date	Date
Check brake fluid and for leaks					
Check breakaway cable					
Check pain for chips and nicks					
Check trailer bunks for abnormal wear					
See information in the Trailer Section regarding post-Storage maintenance					

# **GLOSSARY OF TERMS**



# GLOSSARY OF TERMS

**ABYC** – American Boat and Yacht Council, Inc.

**AFLOAT** – On the water.

**AFT** – Toward the rear or stern of the boat.

**AGROUND** – Touching bottom of a body of water.

**AMIDSHIP** – Center or middle of the boat.

**ANCHOR** – (1) A heavily weighted object designed to grip the bottom of the body of water to hold the boat. (2) The act of setting the anchor.

**ASHORE** – On the shore.

**BAIL** – To remove water from the bottom of the boat with a pump, bucket, sponge, etc.

**BALLAST** – Any solid or liquid weight placed in a boat to increase the draft, and change a boat's position in the water.

**BEAM** – The widest point on the boat.

**BEARING** – The direction of an object from current location.

**BILGE** – The lowest interior section of the boat hull. Generally water is designed to drain to this point on the boat so it can be pumped overboard.

**BOARD** – To enter the boat.

**BOUNDARY WATERS** – A body of water between two areas of jurisdiction; i.e., a river between two states.

**BOW** – The forward portion of the boat.

**BULKHEAD** – Vertical partition (wall) in a boat.

**BUNKS** – Carpeted trailer hull supports. MasterCraft boats rest directly on carpeted trailer bunks when loaded onto their trailers.

**BURDENED BOAT** – Term for the boat that must “give-way” to boats with the right-of-way.

**CAPACITY PLATE** – An informational decal visible from the helm station that provides maximum weight and passengers capacity information.

**CAPSIZE** – To turn over.

**CAST-OFF** – To unfasten mooring lines in preparation for departure.

**CATHODE** – An electrode carrying a negative charge.

**CENTER LINE** – A lengthwise imaginary line which runs fore and aft with the boat's keel.

**CHINE** – The point on a boat where the hull side intersects (meets) the hull bottom.

**CLEAT** – A deck fitting to which mooring lines are fastened.

**STARTER BATTERY** – The main battery used for engine starting and electrical circuits.

**CURRENT** – The flow of water in a body of water. Current can vary in strength and direction.

**DEADRISE** – The vertical distance between a line horizontal to the keel of a vessel and its chine.

**DECK** – The open surface on the boat where the passengers walk.

**DRAFT** – The depth of the boat below the water line, measured vertically to the lowest part of the hull.

**FENDER** – A cushioning device used on the side of a vessel or dock to absorb impact or friction.

**FORE** – Toward the front or bow of the boat. Opposite of aft.

**FREEBOARD** – The distance from the waterline to the upper surface of the side of the deck.

**FUEL SENDING UNIT** – The electrical device mounted on the fuel tank which communicates fuel levels to the dashboard fuel gauge.

**FUEL MANAGEMENT SYSTEM** – An internal computer system in MasterCraft boats that calculates fuel burn and fuel tank volume to give operators precise fuel tank fill levels.

**GIVE-WAY BOAT** – (1) Term for the boat that must take whatever action necessary to keep well clear of the boat with the right-of-way in meeting or crossing situations. (2) The burdened boat.

**GUNWALE (GUNNEL)** – The rail or upper edge of a boat's hull side.

**HEAD** – (1) A marine toilet. (2) Used to describe the compartment or location of a marine toilet.

**HELM** – The steering wheel or command area.

**HULL** – The structural body of a boat below deck.

**HYPOTHERMIA** – A physical condition in which the body loses heat faster than it can produce it.

**KEEL** – The lowest portion of the boat; extending fore and aft along the boat's hull bottom.

**LINE** – Rope. In a marine environment rope is referred to as a "line."

**LIST** – Leaning or tilt of a boat toward the side.

**MAKING WAY** – Making progress through the water.

**MARINE CHART** – Seagoing maps showing depths, buoys, navigation aids.

**MID SHIP** – In the vicinity of the mid-length of a boat, technically the exact half way between the bow and the stern.

**MOORING** – An anchor, chain, or similar device that holds a boat in one location.

**NAVIGATION AID** – Recognizable objects on land or sea such as buoys, towers or lights, used to identify safe and unsafe waters.

**NAVIGATION LIGHTS** – See RUNNING LIGHTS.

**NMMA** – National Marine Manufacturer's Association.

**NO-WAKE SPEED** – The speed at which a boat travels to produce no visible wake.

**OUTBOARD** – (1) Toward or beyond the hull sides of the boat. (2) A detachable engine mounted to the transom of the boat.

**PFD** – Personal flotation device.

**PLANING HULL** – A hull designed to lift, thereby reducing friction and increasing efficiency.

**PORPOISE** – A condition in which the bow bounces up and down caused by trimming the engine too far out of the water. This is particularly apparent in boats running at high speeds with full ballast tanks.

**PORT** – (1) The left side of a boat when facing the bow. (2) A destination or harbor.

**PRIVILEGED BOAT** – Term used for the boat with the right-of-way.

**PROPELLER** – A mechanical device for propelling a boat, consisting of a revolving shaft with two or more broad, angled blades.

**RIGHT-OF-WAY** – Term for the boat that has priority in meeting or crossing situations. The stand on or privileged boat.

**RUB RAIL** – The rubber extrusion that is fastened over the hull and deck joint. The rub rail wraps all the way around the deck and hull.

**RUDDER** – A vertical plate or board used for steering the boat.

**RUNNING LIGHTS** – Also called navigation lights. Lights required for operating a boat between sun-down and sun-up. These include two navigational lights: red (port) and green (starboard), and one white all-around or mast light.

**SLIP** – The linear distance between the pitch (or advance) of the propeller and the actual distance it moves through the water.

**STAND ON BOAT** – Term for the boat that must maintain course and speed in meeting or crossing situations. The privileged boat.

**STARBOARD** – The right side of a boat when looking toward the bow.

**STERN** – The aft or rear end of a boat.

**STOW** – To store cargo off of the deck usually in designated storage compartments.

**STRINGER** – Fiberglass reinforcements under the floor that stiffen the hull bottom.

**SURGE BRAKES** – A type of trailer braking system designed to automatically actuate when the tow vehicle's brakes are applied.

**TRANSDUCER** – The unit that sends/receives signals from the depth sounder.

**TRANSOM** – The transom is the transverse, vertical section that makes up the rear, or stern of a boat directly opposite the bow.

**UNDERWAY** – A boat in motion; i.e., not moored or anchored.

**USCG** – United States Coast Guard.

**VISUAL DISTRESS SIGNAL** – A device used to signal the need for assistance such as flags, lights or flares.

**WAKE** – The waves that a boat leaves behind when moving through the water.

**WAKE SHAPING DEVICE** – Devices that alter the flow of water to change a wake's size and shape.

**WATERLINE** – The line of the water's edge when the boat is afloat.

**WATERWAY** – A navigable body of water.

**WETTED SURFACE** – The area of the hull under the water line and any underwater or running gear mounted to the hull or transom.

# INDEX

# INDEX

3-in-1 Gauge .....	126
12-Volt Receptacle .....	201

## A

Accessory Options, Tower .....	258
Accident Reporting .....	28
Activities Safety, In-Water .....	17
Additional Safety Support .....	207
Afloat, Staying .....	34
After Each Use .....	353
After Storage, Reactivating the Boat .....	376
Alarm, Low Voltage Battery .....	198
Alarms, Other .....	199
Anchoring .....	35
Anchor Lights, Navigation .....	228
Annually (Every 100 Hours) .....	353
Annual Maintenance .....	362
Anode, Zinc .....	336
Anodized Aluminum, Stainless Steel and Chrome .....	337
Attach the Trailer, How to .....	394
Attitude Adjustment Plate .....	234
Axles and Lubrication, Hubs, Wheel Bearings .....	397

## B

Ballast Systems .....	241
Basic Electrical Components .....	193
Basic Maneuvering .....	325
Basic Operations, Starting and .....	319
Battery Alarm, Low Voltage .....	198

Battery Charger .....	199
Battery Connections and Hold-Downs, Inspect .....	355
Battery Is Fully Charged, Check .....	358
Battery, Single .....	196
Before Each Use .....	353
Below Deck .....	216
Bilge System, etc .....	216
Boating Under the Influence .....	26
Boat Operations .....	181
Box, Glove .....	263
Brake Lockout .....	407
Brakes, Manual Bleeding of .....	408
Braking System .....	404
Breakers, Circuit .....	194
Break-In, New Boat .....	316, 352
Buoys and Other Markers, Reading .....	41

## C

Cable, Breakaway .....	391
Cables, Safety .....	381
Canvas Covers .....	243
Carbon Monoxide (CO) .....	08
Care and Maintenance .....	155, 181, 329
Carpet .....	341
Center Drain, etc .....	216
Charts, Nautical .....	33
Checking/Repairing Propellers .....	378
Checks and Services, Safety .....	312
Chrome/Anodized Aluminum, Stainless Steel .....	337
Circuit Breakers .....	194
Cleaning the Boat .....	339
Cleats .....	210
Cold Water Survival .....	34
Comfort and Convenience .....	261

Common Sense Advice .....	05
Communications .....	32
Compartment Lights, Courtesy/Storage .....	231
Control, Operational .....	205
Convenience, Comfort .....	261
Coolers, Removable .....	287
Corrosion, Galvanic .....	336
Corrosion Prevention .....	336
Courtesy/Storage Compartment Lights .....	231
Covers, Canvas .....	268, 343
Crossing .....	40

## D

Damage, Inspect the Exhaust Flaps .....	348
Dashes and Video Screens .....	75
Drain Plugs, etc .....	216
Dual Batteries .....	197

## E

Emergency Treatment for Carbon Monoxide Poisoning .....	09
Enclosed Head .....	349
Engine Flush .....	282
Engine Mounts - Check .....	448
Engines, Ilmor Marine .....	307
Enhancement, Sport .....	233
Events Requiring Safety Knowledge .....	13
Exhaust Flaps for Damage, Inspect .....	448
Exhaust Odors, Note .....	358
Extinguishing, Fire Suppression and .....	208
Exhaust, Underwater .....	219

## F

Fire Extinguishers .....	14
Fishing Vessel Right-of-Way .....	41

Float Plan .....	34
Frequency and Scheduled Maintenance .....	352
Fuel Gauge: 3-in-1 .....	126
Fuel Levels .....	309
Fuel System, Inspect the Complete .....	366
Fuel System for Leaks, Inspect .....	357
Fuel System Treatment .....	370

## G

Galvanic Corrosion .....	336
Gauges and Switches, Variations in .....	77
Gauges, X Series Engine .....	85, 125
General Precautions .....	03
General Preparation .....	370
General Prudential Rule .....	38
Glove Box .....	267
Growth, Marine .....	342

## H

Hazardous Operations .....	06
Head and Toilet System .....	283
Head, Enclosed .....	345
Heater .....	264
Hints, Operational .....	323
Hitching Up .....	411
Hold-Downs, Inspect the Battery Connections .....	355
Horn .....	211
How to Attach the Trailer .....	394
How to Protect Yourself and Others .....	10
Hull .....	340

## I

Ignition Key Slot .....	201
-------------------------	-----

Ignition Start-Stop .....	203
Ilmor Marine Engines .....	307
Inflatable Life Rafts .....	35
Inspections .....	360
Inspect Battery Connections and Hold-Downs .....	355
Inspect Complete Fuel System .....	366
Inspect Exhaust Flaps for Damage .....	363
Inspect Fuel System for Leaks .....	357
Inspect Throttle and Shift Cables .....	356
Insurance .....	33
In the Event of a Fire .....	14

## J

Jack, Trailer .....	409
---------------------	-----

## K

Key Slot, Ignition .....	201
--------------------------	-----

## L

Ladders .....	292
Launching Tips and Techniques .....	418
Law Enforcement .....	26
Leaks, Inspect The Fuel System .....	332
Legal Requirements .....	25
Life, Inflatable Rafts .....	35
Lifting Eyes, Using .....	332
Lifting Slings, Using .....	332
Lifting the Boat .....	335
Light, Courtesy/Storage Compartment .....	231
Lockout, Brake .....	407
Low Voltage Battery Alarm .....	198
Lubricate the Steering System .....	353

## M

Maintenance, and Care .....	329
Maintenance, Scheduled .....	352
Maintenance Service .....	351
Maintenance (Trailer) .....	425
Manual Bleeding of Brakes .....	408
Marine Growth .....	338
Meeting .....	39
Mirrors .....	211
Model Features and Specs .....	45

## N

Nautical Charts .....	33
Navigational Lights .....	24
Navigation/Anchor Lights .....	228
New Boat Break-In .....	316, 352
Note Any Exhaust Odors .....	358
NXT20/22/24 Video Screen .....	179
NXT Instrument Panel .....	173
NXT Operations .....	173

## O

Odors, Note Any Exhaust .....	358
Operational Control .....	205
Operational Hints .....	223
Operations, Boat .....	191
Operations, Starting and Basic .....	319
Operator's License .....	26
Operator's Responsibilities .....	06
Other Alarms .....	199
Overtaking .....	40

## P

Personal Flotation Devices (PFD) and Accessibility .....	12
Plan, Float .....	34
Plate, Attitude Adjustment .....	234
Platforms .....	341
Pollution, Refuse .....	29
Preparation .....	301
Preparation, General .....	370
Prevention, Corrosion .....	336
Propellers, Checking/Repairing .....	378
ProStar Video Screen .....	153
Pylons .....	246

## Q

Quarterly - Every Fifty (50) Hours .....	362
--	-----

## R

Racks, Ski .....	251
Radios, Telephone .....	29
Rafts, Inflatable Life .....	35
Reactivating the Boat After Storage .....	376
Reading Buoys and Other Markers .....	41
Receptacle, 12-Volt .....	201
Recommended Equipment .....	22
Refuse and Pollution .....	29
Registration, Numbering and Documentation .....	27
Removable Coolers .....	287
Repeat Check for Fuel and/or Exhaust Leaks .....	359
Requirements, Towing .....	420
Right-of-Way, Fishing Vessel .....	41
Right-of-Way, Sailing Vessel .....	41
Rules, General Prudential .....	38
Rules of the Open Water .....	37
Rules When Encountering Vessels .....	38

Running Aground or Striking Underwater Objects .....	17
--	----

## S

Safety Afloat .....	04
Safety Cables .....	381
Safety Checks and Services .....	311
Safety Equipment .....	22
Safety Knowledge .....	01
Safety Stop Switch, Emergency .....	204
Sailing Vessel Right-of-Way .....	41
Salt Water Corrosion .....	336
Starting and Basic Operations .....	320
Scheduled Maintenance .....	365
Scheduled Maintenance, Frequency .....	354
Scuppers, etc .....	216
Sea Strainers, etc .....	216
Seat Lift, Gas Assisted .....	297
Service Log - Boat .....	447
Service Log - Trailer .....	449
Service, Maintenance .....	351
Services, Safety Checks .....	311
Single Battery .....	196
Ski Racks .....	251
Ski/Wakeboard/Surf Rope .....	213
Slot, Ignition Key .....	201
Sound Production Devices .....	23
Speeding and Noise .....	28
Speedometer .....	126
Sport Enhancement .....	233
Stainless Steel and Chrome/Anodized Aluminum .....	337
Start-Stop, Ignition .....	203
Staying Afloat .....	34
Steering and Sailing Rules/Sound Signals .....	38
Steering System .....	222



Steering System, Lubricate .....	363
Stereo Components .....	262
Stern Thruster .....	224
Storage Compartment Lights, Courtesy .....	231
Storage Cradle .....	332
Storage, Reactivating the Boat After .....	376
Storage Space .....	291
Storage & Winterization .....	369
Suppression and Extinguishing, Fire .....	15
Surf Rope, Ski/Wakeboard .....	213
Surf Sleeves .....	298
Surf Star System .....	238
Survival, Cold Water .....	34
Swim Platform Canvas, Transom .....	272
Swing Tongue .....	384
Switch, Engine Emergency Safety Stop .....	204
Switch, Variations in Gauges and .....	75

## T

Tachometer .....	126
Telephones, Radio .....	29
The Trailer Hitch .....	389
Tie Downs .....	410
Tips and Techniques (Launching) .....	418
Tips and Techniques, Trailer .....	415
Toilet System, Head .....	283
Tongue, Swing .....	384
Tower Accessory Options .....	258
Towers .....	251
Towing Requirements .....	420
Trailer Jack .....	409
Trailers .....	383
Trailer Tips and Techniques .....	415
Trailer Winch Assembly .....	393

Transom/Swim Platform Canvas .....	272
Transom Drain Plugs, etc .....	216
Treatment, Fuel System .....	370

## U

Upholstery .....	345
Using Care When Fueling .....	304
Using Lifting Eyes .....	332
Using Lifting Slings .....	332
Underwater Exhaust .....	219

## V

Variations in Gauges and Switches .....	77
Video Screens, Dashes and .....	75

## W

Surf Rope, Ski/Wakeboard .....	213
Warning Plates and Labels .....	24
Weather .....	33
Weight Distribution (Trailer) .....	389
Weight Limits and Distribution .....	11
Wheels .....	399
Where CO May Accumulate .....	09
Winch Assembly, Trailer .....	397
Windshield .....	342

## X

X Series Instrument Panel .....	79, 80
X Series Video Screen HV550 .....	117

## Z

Zinc Anode .....	336
------------------	-----



## **WARNING**

Operating, servicing and maintaining a recreational marine vessel can expose you to chemicals including engine exhaust, carbon monoxide, phthalates, and lead, which are known to the State of California to cause cancer and birth defects or other reproductive harm. To minimize exposure, avoid breathing exhaust, service your vessel in a well-ventilated area and wear gloves or wash your hands frequently when servicing this vessel. For more information go to [www.P65warnings.ca.gov/marine](http://www.P65warnings.ca.gov/marine).