



MEDALLION
INSTRUMENTATION SYSTEMS





"EXCEEDING
CUSTOMER
NEEDS
THROUGH
INNOVATION"

MASTERCRAFT UNIVERSITY

INSTRUMENTATION TRAINING

PART I

(FEB 2012)

CONTENTS:

- **SYSTEM OVERVIEW**
- ➔ **SYSTEM CONFIGURATIONS**
- ➔ **TRIM & BALLAST SYSTEM**
- ➔ **GDIG SPEEDOMETER AND GAUGES**
- ➔ **OPTIONAL COLOR TOUCH II DISPLAY**

MASTERCRAFT
MY2012 INSTRUMENT SYSTEMS
(A SCALABLE SYSTEM)

MASTERCRAFT MY2012 SYSTEMS DIAGRAM

(BASE SYSTEM WITH IMPROVED MC CRUISE)

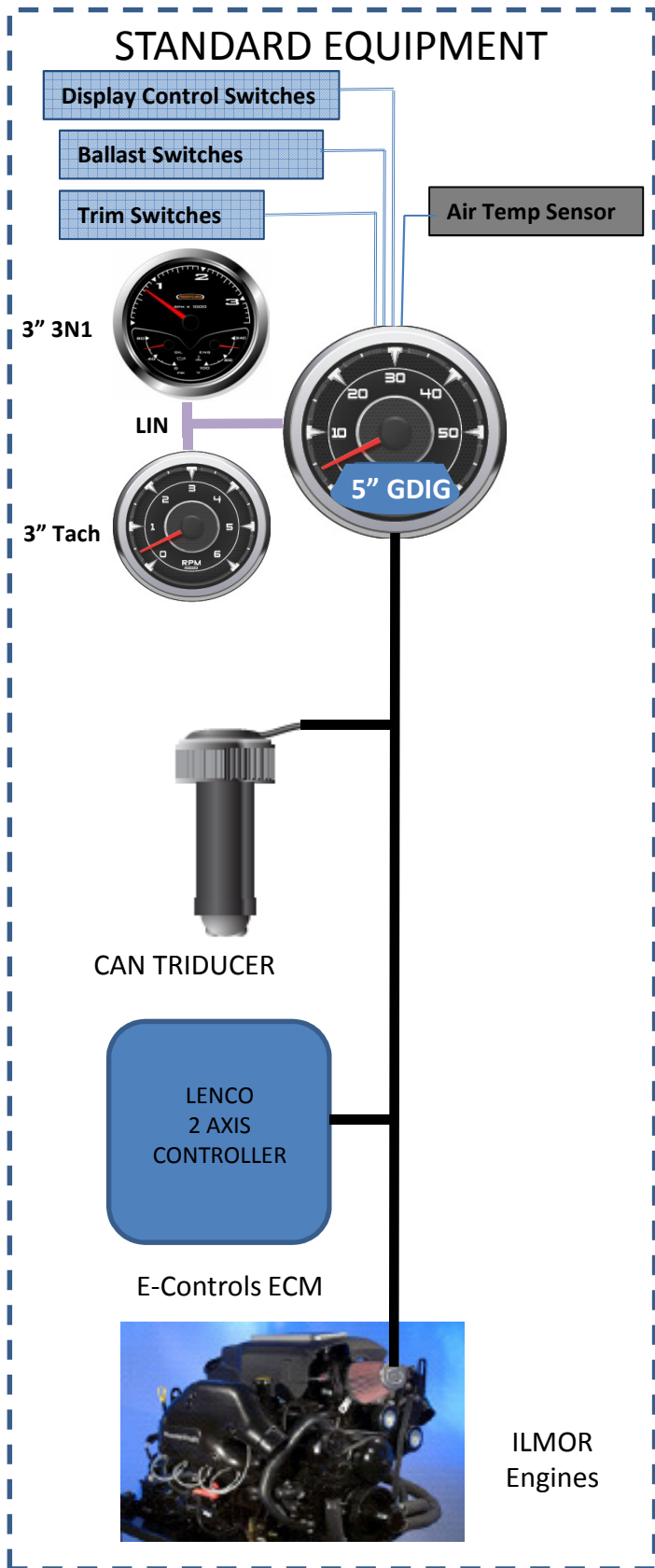

MASTERCRAFT MY2012 SYSTEMS DIAGRAM

(BASE SYSTEM WITH ZERO OFF SPEED CONDTROL)

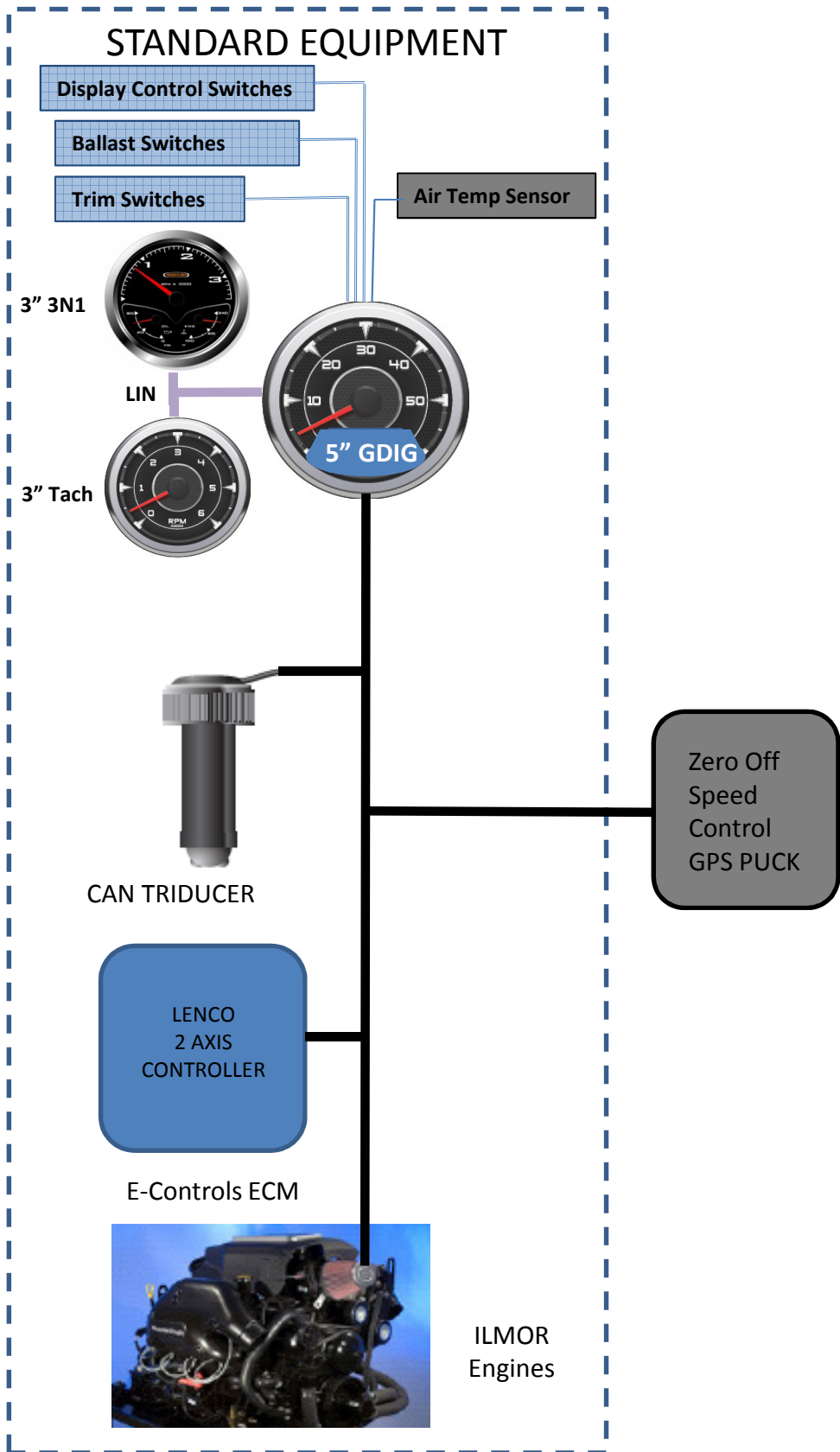

MASTERCRAFT MY2012 SYSTEMS DIAGRAM

(OPTIONAL DISPLAY WITH WAKEBOARD PRO SPEED CONTROL)

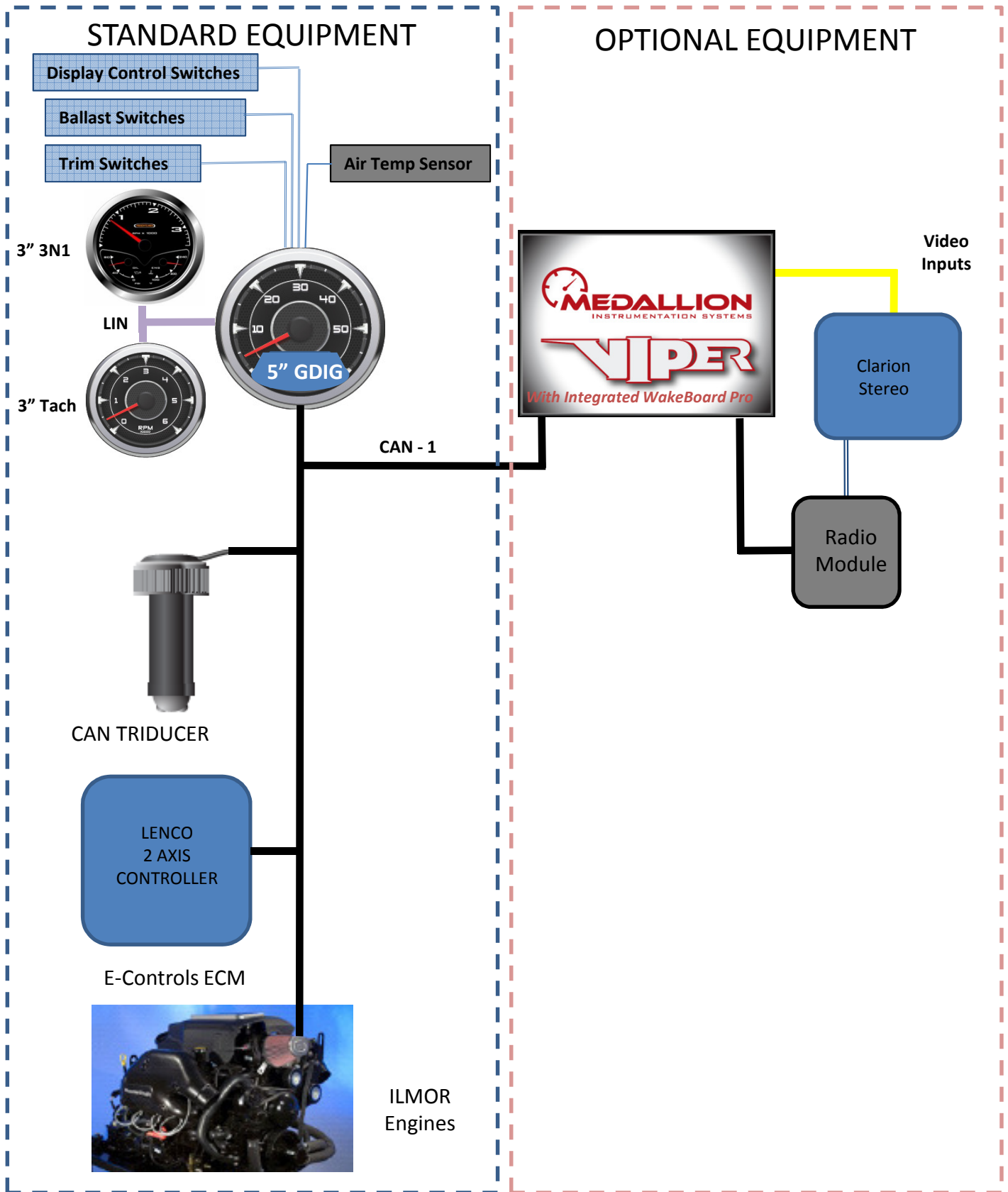

MASTERCRAFT MY2012 SYSTEMS DIAGRAM

(OPTIONAL DISPLAY WITH ZERO OFF GPS SPEED CONTROL)

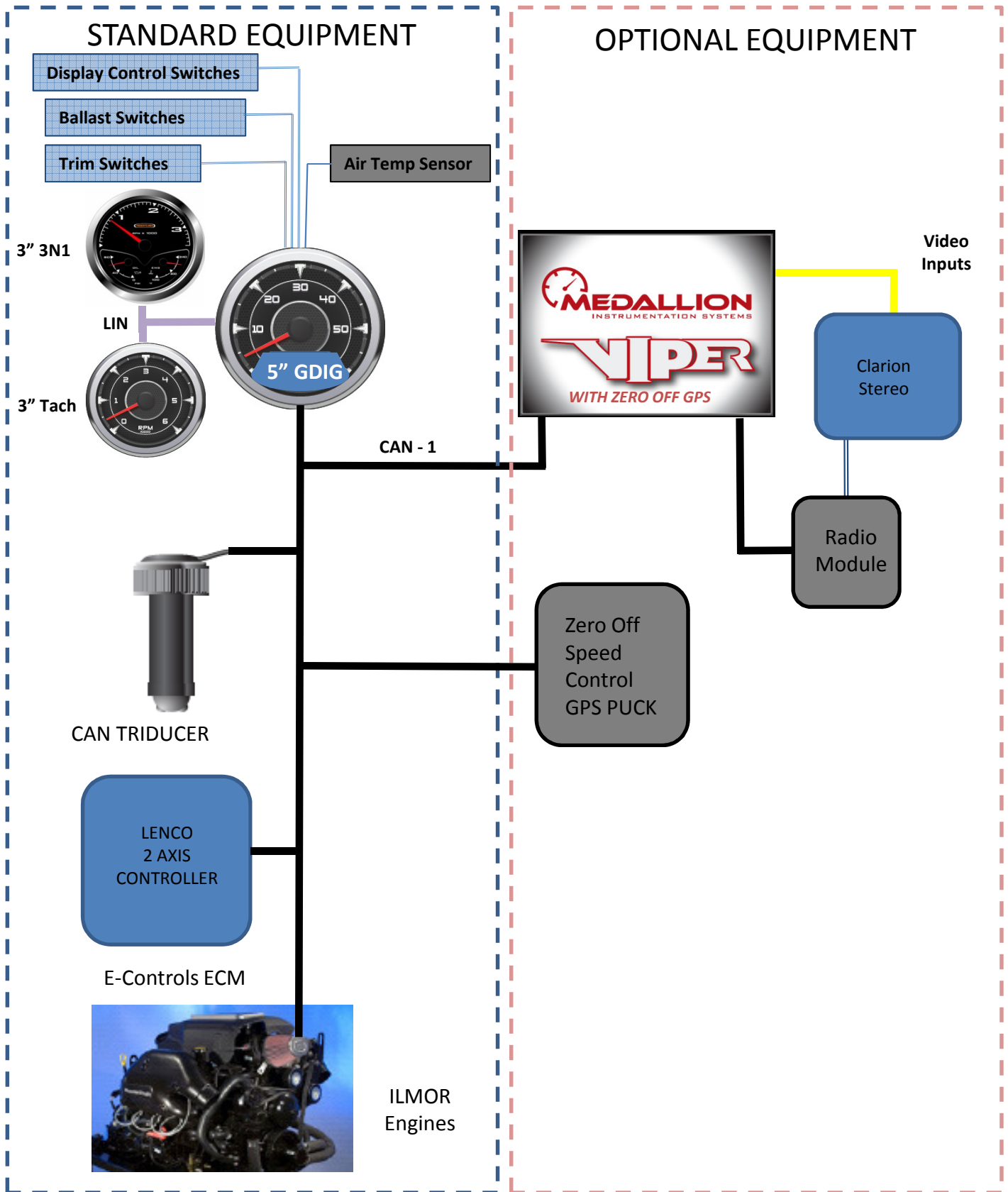

MASTERCRAFT MY2012 SYSTEMS DIAGRAM

(OPTIONAL DISPLAY WITH ZERO OFF 3 EVENT SPEED CONTROL)

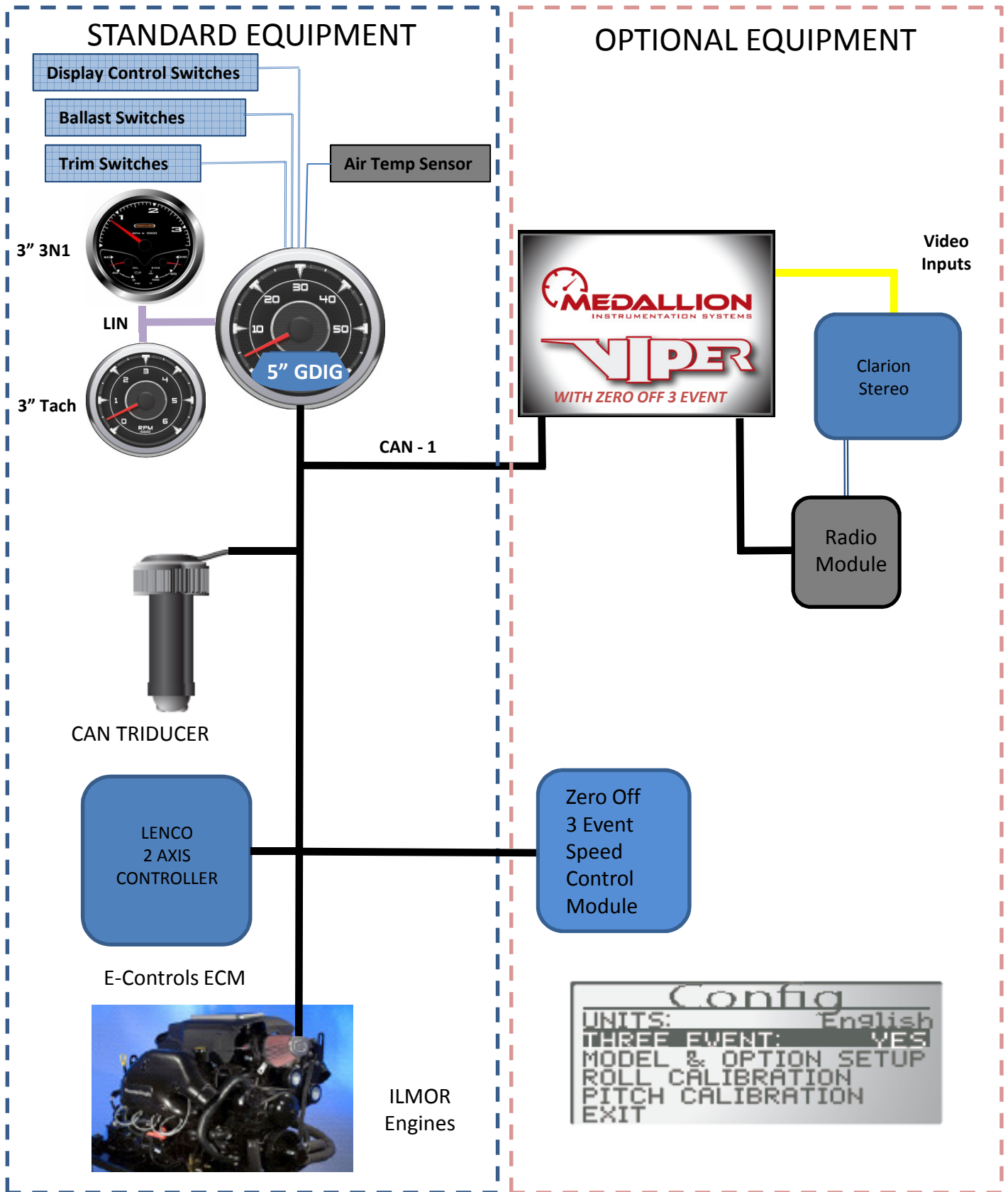

MASTERCRAFT MY2012 SYSTEM DIAGRAM (ALL OPTIONS SHOWN)

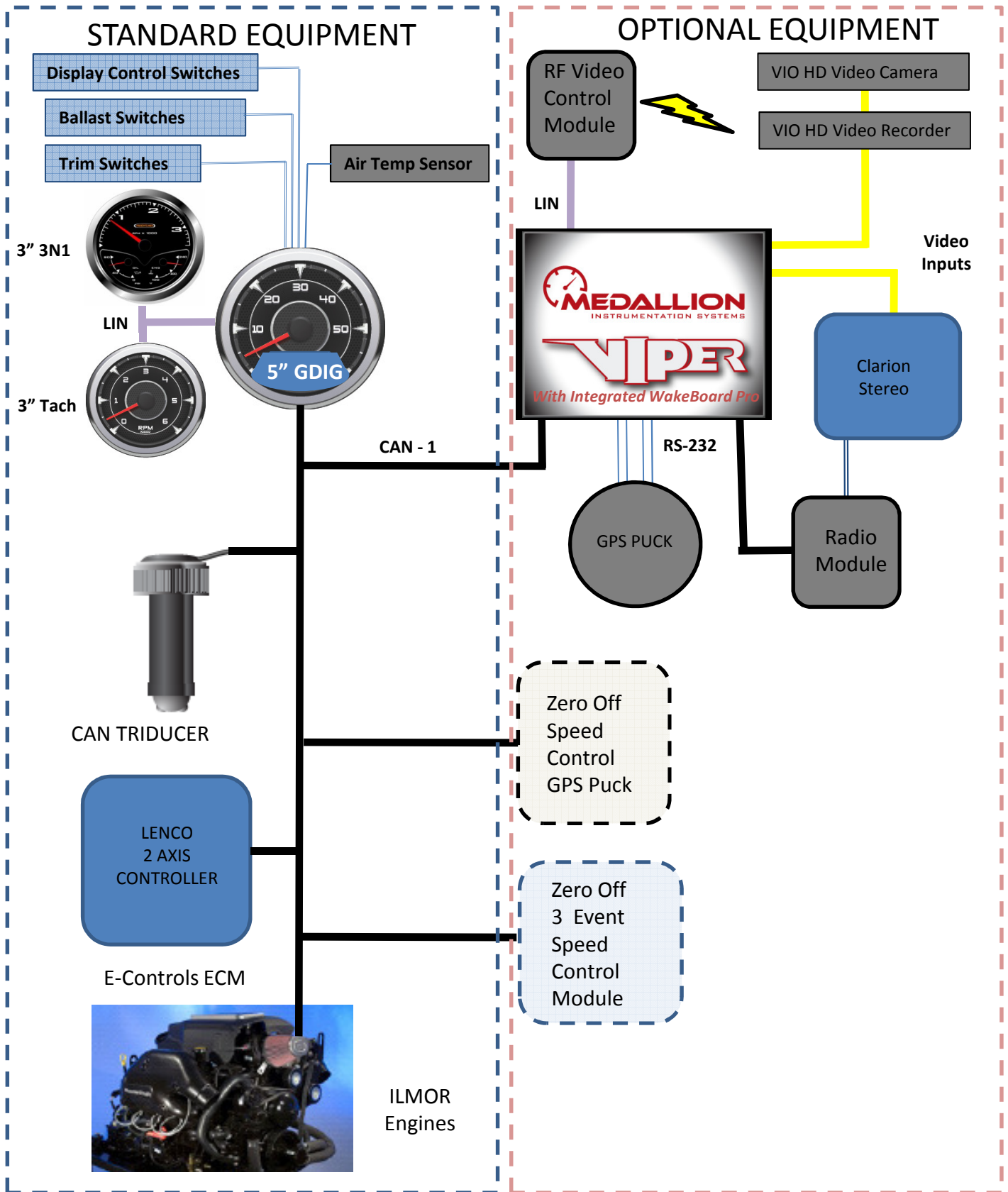

MASTERCRAFT MY2012 SPEED CONTROL SYSTEMS

System Level Cruise Control Priority

The Cruise Control Application with the highest Priority, with one being the highest priority and four being the lowest priority, as illustrated in the table below shall assume control and all Applications of a lower Priority shall be disabled.

Priority	Cruise Control Application	Key
1	Zero Off 3 Event	3 Event Module Source Address
2	Zero Off Wakeboard	Zero Off GPS Puck Source Address
3	Perfect Pass Wakeboard Pro	Touch II Display Source Address
4	Master Cruise	Default

Effectively, Master Cruise should be disabled anytime a Touch II display is installed in the system.



MasterCraft MY2012

Trim and Ballast Control

Learning Objectives

UPON THE COMPLETION OF TRAINING THE STUDENTS SHALL:

- ➔ Explain the features of the MY2012 Trim & Ballast System.
- ➔ Describe normal operation of the system.
- ➔ Know where to find and how to use the system configuration tools:
- ➔ Draw a simplified block diagram of the Trim and Ballast System.
- ➔ Explain the function of each block in the system.
- ➔ Know how to determine the software version of each Block.
- ➔ Have a familiarity with basic troubleshooting techniques.
- ➔ Know where to find the pin-out information for associated connectors.
- ➔ Be aware of Lenco Module Mounting Constraints.
- ➔ Be aware of and know how to perform any relevant campaigns.

Features & Benefits

- ➔ Based on proven Lenco Auto-Glide Technology
- ➔ Eliminates the need for Tank Sensors
- ➔ Auto-Launch Feature
- ➔ Anti-Swamp Feature
- ➔ Auto-Leveling Feature

Manual Trim Tab Operation

- ➔ When equipped with tabs the Drivers side armrest contains switches to manually control the available tabs.



- ➔ Operation of the switches was designed to eliminate guesswork while underway:
 - Press **DOWN** to lower the bow
 - Press **LEFT** to roll the boat left (Port)
 - Press **RIGHT** to roll the boat right (Starboard)

Manual Ballast Operation

- ➡ When equipped with Tanks the Drivers side armrest contains switches to manually fill and drain the available tanks.



SWITCH STATUS TRANSMISSION

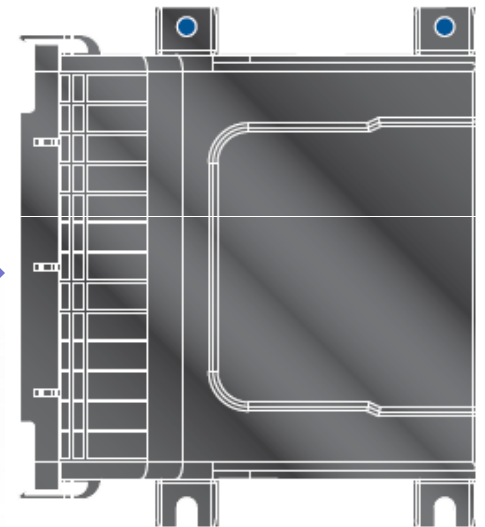

MasterCraft MAIN 2012 SCREENS

CRUISE OFF

Use the select button to pick the desired preset



CRUISE ON

Plug in play depth info

Shows preset that is active

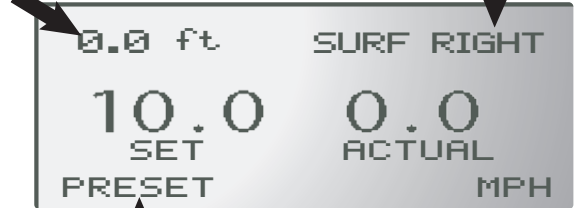

Mode

Auto = Auto tabs

Preset = Auto tabs and tanks

Manual = switch controlled

DEPTH SCREEN

Depth screen goes away when there is no Depth installed



ENGINE INFO SCREEN



BALLAST SCREEN

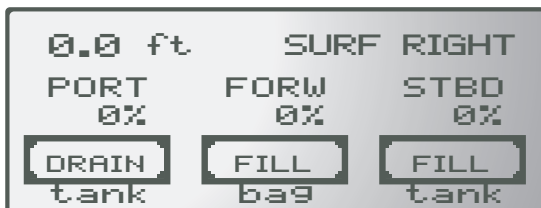

Will display bags or tanks depending on the valve status or NC if valve is not connected to either tank or bag.

TABS SCREEN

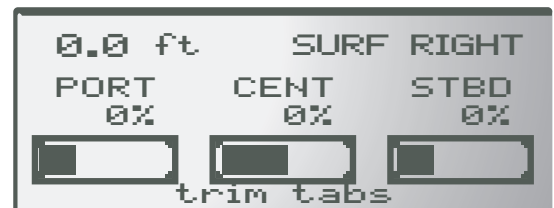

SETUP is accesable when below 800 rpm
press select button to access setup menus.

System Configuration Tools

- ➔ The Trim and Ballast System is Configured for the correct boat model and installed options at the plant.
- ➔ Should adjustments ever need to be made the GDIG Speedometer contains a configuration sub-menu that allows the configuration of:
 - Boat Model and installed options
 - Roll Calibration
 - Pitch Calibration
 - Return to factory settings

System Configuration Tools

Boat Model and Installed Option Configuration

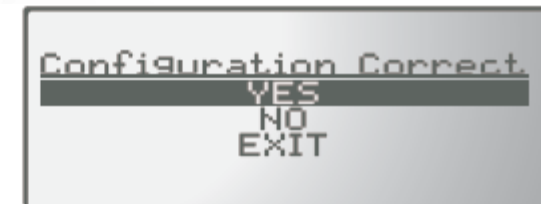
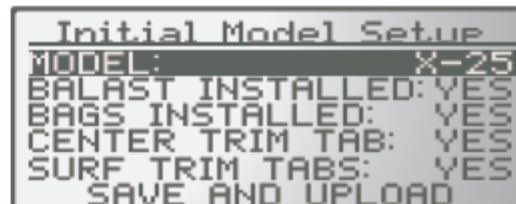

- ➔ Reconfiguring the Boat Model and Options will reset the Roll and Pitch settings to their original factory settings.

System Configuration Tools

Roll Calibration



The SETUP menus are only accessible when the engine RPMs are below 800. The setup menus will all exit automatically after 5 seconds except the for the menus the have an EXIT option.

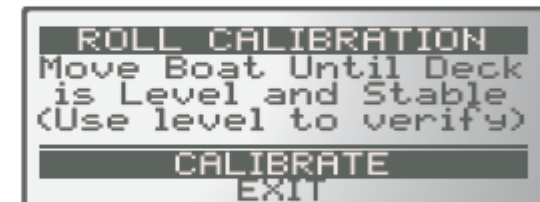

The ROLL CALIBRATION is used to change the level attitude of the boat. This should only be done with the boat in a level and stable position. In correctly performing this operation will affect the boats operation.

System Configuration Tools

Pitch Calibration

```
Config
-----
UNITS:      English
THREE EVENT: NO
MODEL & OPTION SETUP
ROLL CALIBRATION
PITCH CALIBRATION
EXIT
```

```
PITCH CALIBRATION
-----
Accel. to 4000 rpm
Drive boat straight
< Auto exits at end >
Press Cruise to start
```

The PITCH CALIBRATION will automatically calibrate the boats systems when activated Perform this operation in a lake that is calm. The process takes about 66 seconds to complete. A successful calibration will be confirmed with a message. If the message FAILURE appears the process will need to be repeated.

```
PITCH CALIBRATION
-----
.....In Process.....
Auto exits when Done
```

```
EXIT
SUCCESS!
```

```
FAILURE!
```

Determining Software Revision Levels



The SETUP menus are only accessible when the engine RPMs are below 800. The setup menus will all exit automatically after 5 seconds except the for the menus the have an EXIT option.

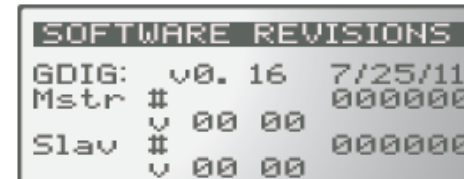

The SOFTWARE REVISIONS selection in the DIAGNOSTIC TOOLS will show the current software revisions for the GDIG (gauges) and the Lenco modules.



MASTERCRAFT My2012 AUTO GLIDE PUMP 3 TANKS - NO TABS

LENCO MARINE
4700 SE MUNICIPAL CT.
STUART, FL 34997
TEL: 772-288-2662

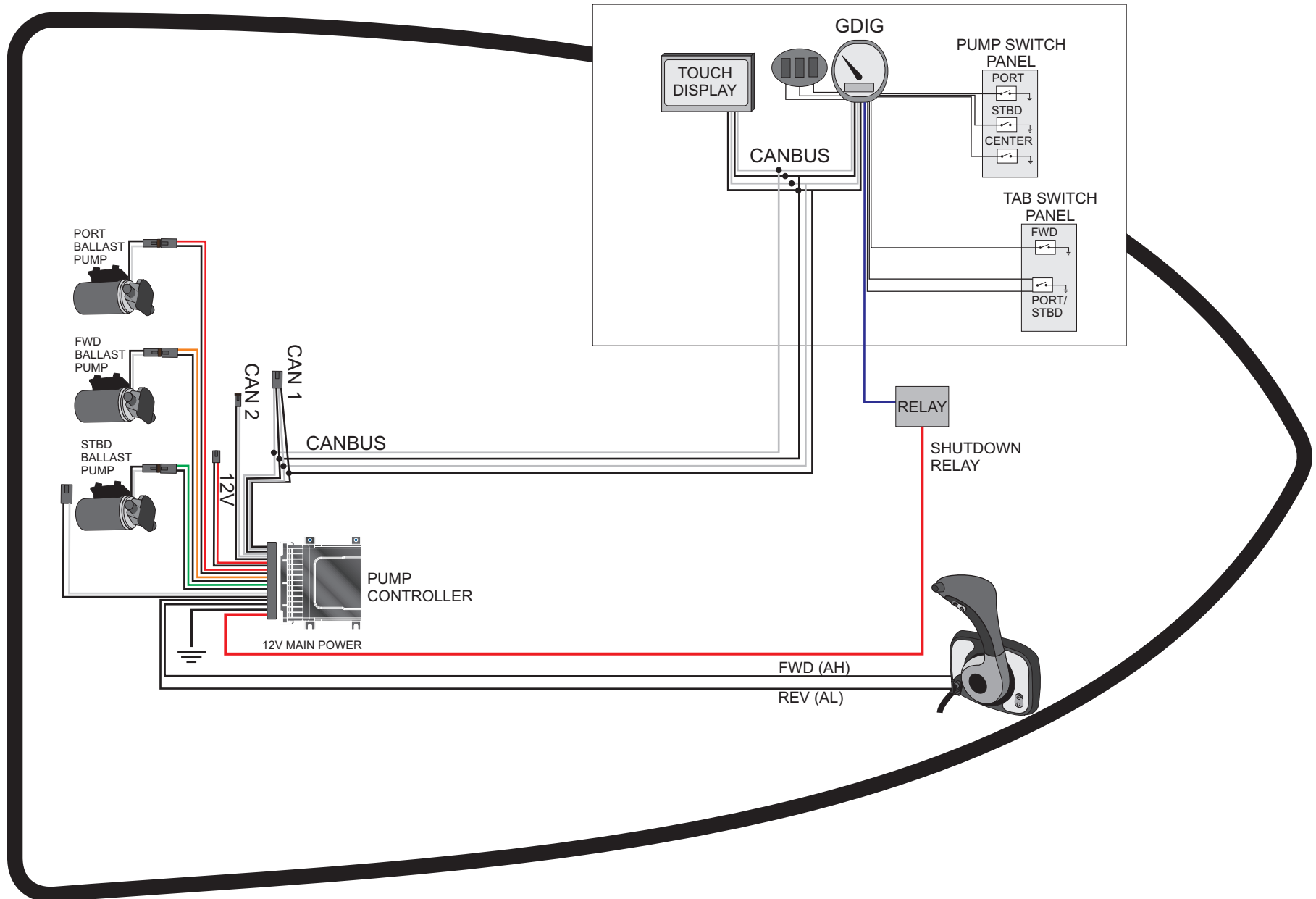



MASTERCRAFT My2012 AUTO GLIDE PUMP 3 TANKS - 1 TAB

LENCO MARINE
4700 SE MUNICIPAL CT.
STUART, FL 34997
TEL: 772-288-2662

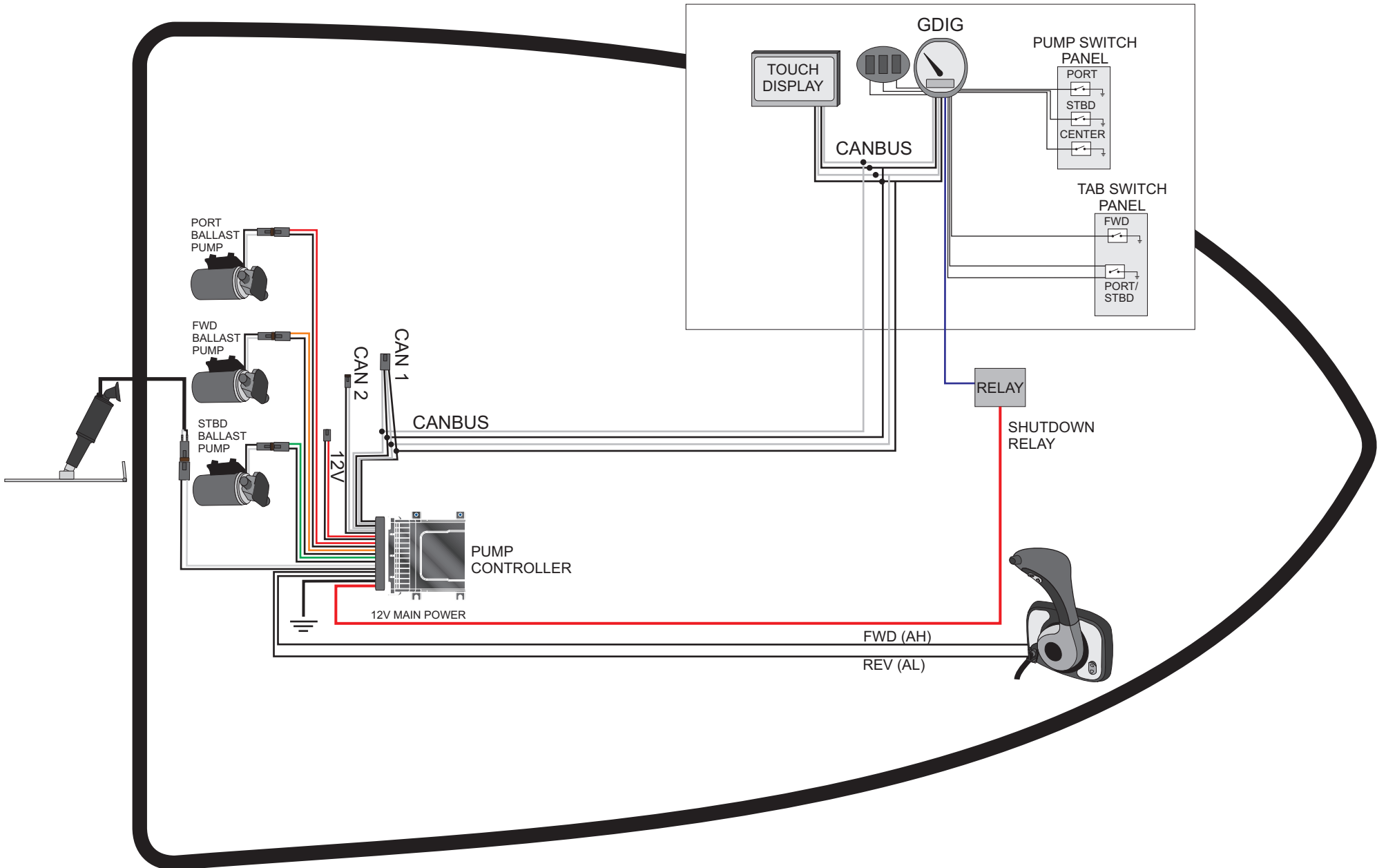



MASTERCRAFT My2012 AUTO GLIDE PUMP & SURF CONTROLLERS 3 TANKS - 3 TABS

LENCO MARINE
4700 SE MUNICIPAL CT.
STUART, FL 34997
TEL: 772-288-2662

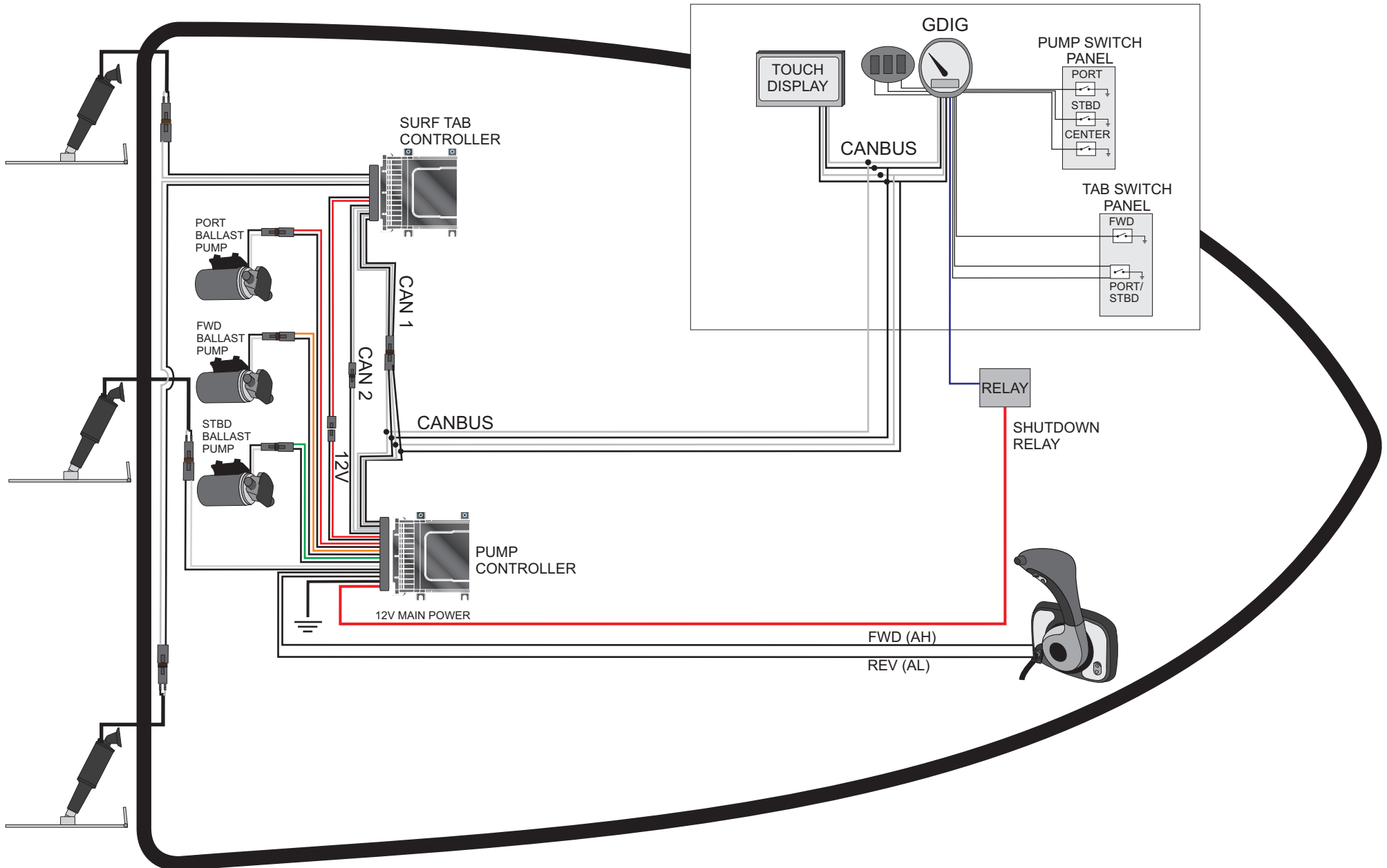



MASTERCRAFT My2012 AUTO GLIDE PUMP & SURF CONTROLLERS 3 TANKS - 3 BAGS - 3 TABS

LENCO MARINE
4700 SE MUNICIPAL CT.
STUART, FL 34997
TEL: 772-288-2662

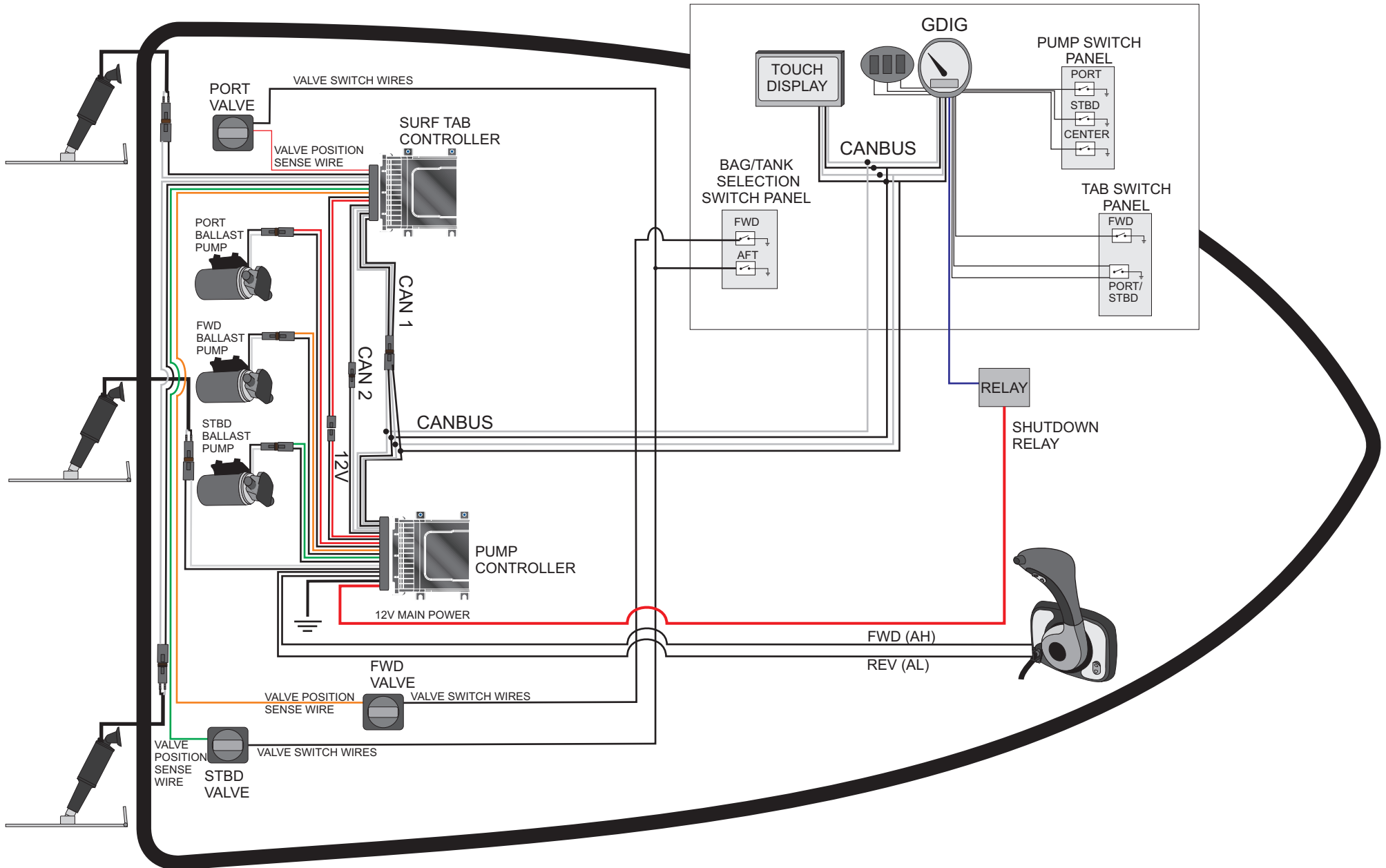

GDIG CONNECTOR

2012 MasterCraft

Pin	Function	Voltages
1	Ground	
2	Battery	9 to 16
3	Switched power	9 to 16
4	CAN High	1 to 5
5	CAN Low	1 to 5
6	CAN SHIELD	
7	Back lighting	0 to 16
8	UP/DOWN button	0 to 12 vdc
9	port ballast	0 to 12 vdc
10	Forward ballast	0 to 12 vdc
11	Starboard ballast	0 to 12 vdc
12	Roll switch	0 to 12 vdc
13	Pitch switch	0 to 12 vdc
14	Select Switch/lake temp	0 to 12 vdc
15	Cruise switch	0 to 12 vdc
16	Buzzer	

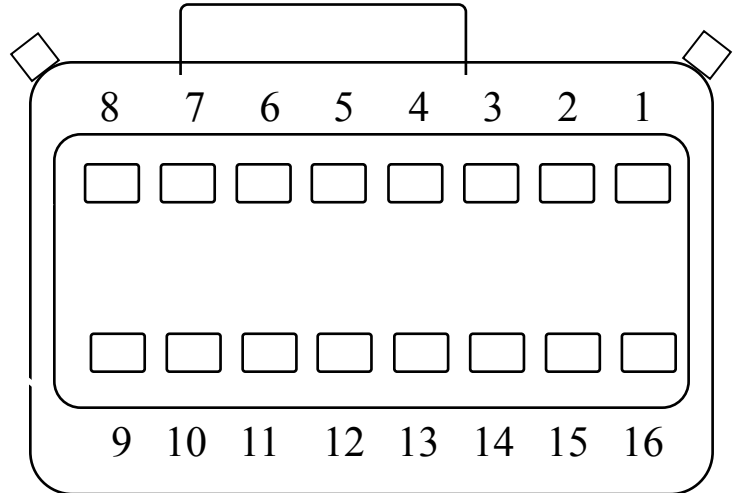
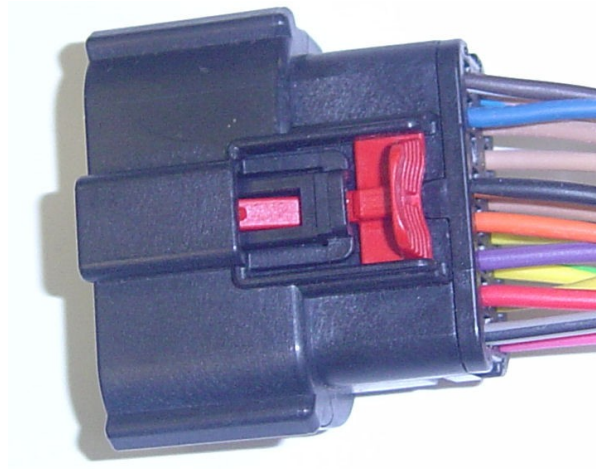

5. HARDWARE SPECIFICATIONS

5.1. Master Controller Pinout

The master controller interface to the system must be provided through a 30 position Cinch header. Each pin must support a continuous current of 10 Amps at 85 °C. The pinout of this connector must be as follows:

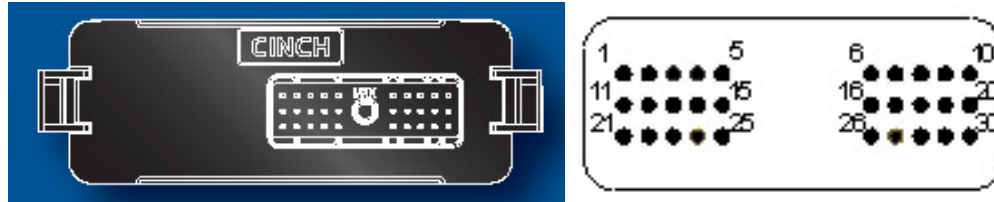

Term	Conn Term	Designation	Description
1	1A	Out 4 H	Center Tab H
2	1B	Out 4 L	Center Tab L
3	1C	Freq IN2	Not used
4	1D	BIN 1	Forward Gear (Binary AH)
5	1E	CAN 1 H	Vessel CAN H (isolated)
6	1F	CAN 2 H	Slave CAN (non-isolated)
7	1G	OUT 3 H	Center Pump H
8	1H	OUT 3 L	Center Pump L
9	1J	CAN 1 GND	Vessel CAN isolated ground
10	1K	CAN 1 PWR	Vessel CAN isolated power
11	2A	GND	Battery Ground
12	2B	GND	Battery Ground
13	2C	CAN 2 PWR	Not used
14	2D	Freq IN1	Not used
15	2E	CAN 1 L	Vessel CAN L (isolated)
16	2F	CAN2 L	Slave CAN L (non-isolated)
17	2G	VBAT	Battery
18	2H	NMEA0183+	Not used
19	2J	NMEA0183-	Not used
20	2K	VBAT	Battery
21	3A	OUT2 L	Port Pump L
22	3B	OUT2 H	Port Pump H
23	3C	GND	Battery GND
24	3D	GND	Battery GND
25	3E	BIN 2	Reverse Gear (Binary AL)
26	3F	CAN 2 GND	Not used
27	3G	VBAT	VBAT
28	3H	VBAT	VBAT
29	3J	OUT 1 H	Starboard Pump H
30	3K	OUT1 L	Starboard Pump L

5.1.1. HARNESS CONNECTION

Cinch US Part Number: 581 01 30 029 (important for key)

Terminals 425 00 00 872 (20 GXL, 18 TXL) 425 00 00 873 (18 GXL, 16 TXL, 16 GXL)

Cavity Seal Plug (for empty circuits) 581 00 00 011

5.2. Slave Controller Pinout

The slave controller interface to the system must be provided through a 30 position Cinch header. Each pin must support a continuous current of 10 Amps at 85 °C. The pinout of this connector must be as follows:

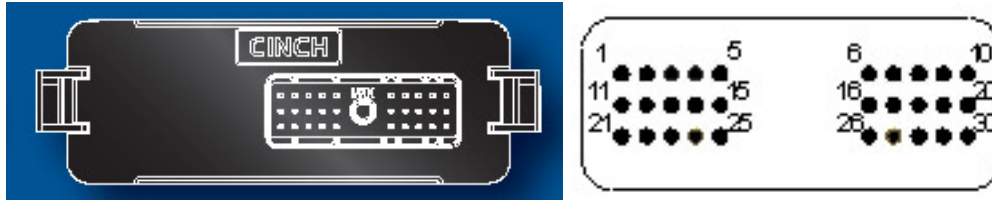

Term	Conn Term	Designation	Description
1	1A	Out 4 H	Not used
2	1B	Out 4 L	Not used
3	1C	Freq IN2	Center Valve Tank (modified AL)
4	1D	BIN 1	Port Valve (RAI)
5	1E	CAN 1 H	Vessel CAN H (isolated)
6	1F	CAN 2 H	Slave CAN 2 (non-isolated)
7	1G	OUT 3 H	Not used
8	1H	OUT 3 L	Not used
9	1J	CAN 1 GND	Vessel CAN isolated ground
10	1K	CAN 1 PWR	Vessel CAN isolated power
11	2A	GND	Battery Ground
12	2B	GND	Battery Ground
13	2C	CAN 2 PWR	Not used
14	2D	Freq IN1	Center Valve Bag (modified AL)
15	2E	CAN 1 L	Vessel CAN L (isolated)
16	2F	CAN2 L	Slave CAN L (non-isolated)
17	2G	VBAT	Battery
18	2H	NMEA0183+	Not used
19	2J	NMEA0183-	Not used
20	2K	VBAT	Battery
21	3A	OUT2 L	Port Tab L
22	3B	OUT2 H	Port Tab H
23	3C	GND	Not used
24	3D	GND	Not used
25	3E	BIN 2	Starb Valve (RAI)
26	3F	CAN 2 GND	Not used
27	3G	VBAT	VBAT
28	3H	VBAT	VBAT
29	3J	OUT 1 H	Starb Tab H
30	3K	OUT1 L	Starb Tab L

5.2.1. HARNESS CONNECTION

Cinch US Part Number: 581 01 30 029 (important for key)

Terminals 425 00 00 872 (20 GXL, 18 TXL) 425 00 00 873 (18 GXL, 16 TXL, 16 GXL)

Cavity Seal Plug (for empty circuits) 581 00 00 011

5.3. Controller Power

The controllers must function in a 12V or 24V environment. The power supply for the controllers must be protected from overvoltage and reverse polarity.



GENERAL TROUBLESHOOTING FOR LENCO ACTUATORS

Step 1: Check to make sure that the Deutsch Connectors are firmly attached. If the connection is loose, firmly press the two connectors together.

Step 2: If fault continues, swap the connections to the actuators. Disconnect the actuators from the control box and reconnect the actuators to the opposite control box outputs.

Step 3: If fault continues, disconnect the Deutsch Connectors and remove the orange wedge. Remove the wire leads from the connector by depressing the small latches inside the connector housing and pulling on the wire leads.

Step 4: Once the wires are removed from the housing, touch the white wire leads to a Positive (+) 12V Battery Terminal and the black wire leads to a Negative (-) 12V Battery Terminal. The actuator should extend while connected to the battery. Reverse the polarity of the wire leads to the battery terminals and the actuator should retract.

Step 5: If the actuator does not extend and retract, replace the actuator. If the actuator extends and retracts properly, re-assemble the connector taking care to properly seat the wire leads into the connector housing.

Step 5: Attach the port and starboard connectors to the system. If the fault reading continues, contact Lenco's Customer Service at: info@lencomarine.com or 772-288-2662

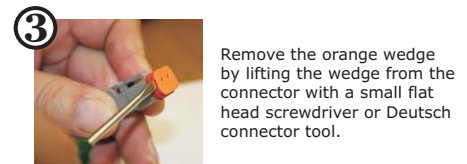
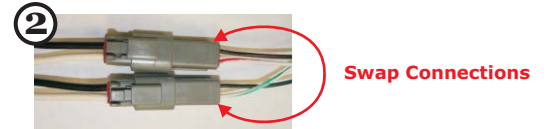
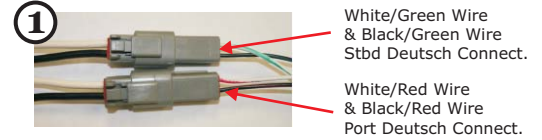

ACTUATOR

Deutsch Connection Instructions

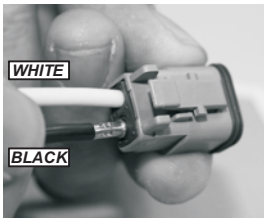

Insert white wire into #1 grommet hole and black wire into grommet hole #2. Make sure to insert wires until contacts lock into place.



Once both contacts are in place, insert orange wedge as shown.

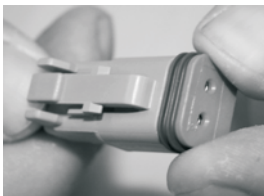

Push in orange wedge until audible snap is heard.



Lenco Marine, Inc.
772-288-2662 / www.lencomarine.com

TITLE: GDIG Speedometer Firmware Update

Population Affected:

MY2012 MasterCraft boats that have a Medallion 8653-00107-00 or 8653-00113-00 GDIG Speedometer installed.

Symptoms:

Customers complain that the ballast pumps shut off before the tanks are empty.

Cause:

In early revisions of the GDIG firmware the value of the Run Dry Current Sense Threshold transmitted to the Lenco Controller was too close to the normal run current.

Solution:

The Sense Threshold level was corrected in Revision 20 of the software. All MasterCraft MY2012 Speedometers should have Revision 20 or higher Software installed.

Speedometer Location:



Speedo Location

Determining the installed Software Revision Level:

- Scroll the Speedometer's Graphical Display to:
SETUP \ DIAGNOSTIC TOOLS \ SOFTWARE REVISIONS

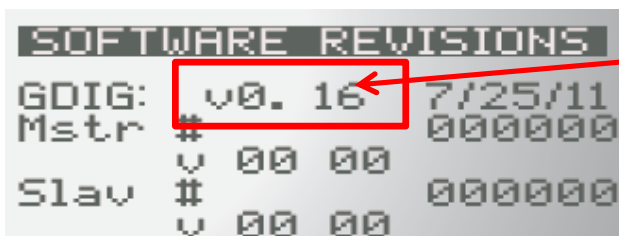

```
SOFTWARE REVISIONS
GDIG: v0. 16 7/25/11
Mstr # 000000
v 00 00
Slav # 000000
v 00 00
```

Revision V0.20 or Higher

- The software revision level of the installed GDIG Speedometer and Lenco Control Modules is displayed.

Required Tools and Materials:

- A Phillips Screwdriver
- A Medallion Universal Programming Tool and Harness



(MIS Kit Number: 8960-00215-01)

Procedure:

- ❑ Remove the access panel below the dash to allow access to the Speedometer.
- ❑ Disconnect the 16 Pin Molex Connector from the back of the Speedometer. To remove this connector pull back on the red secondary locking tab, push the connector toward the gauge to unload the latch system, then depress the main latch on the top side of the connector, while gently pulling the connector away from the Speedometer.
- ❑ Apply 12 Volt DC power to the programmer via the lighter plug on the provided programming harness. The programmer will briefly display a splash screen identifying the installed software version. After a couple of seconds the programmer will scroll to the screen illustrated below:



- ❑ The programmer may be used to update the software in either the Zero Off version or the standard version of the speedometer. The operator must select the desired software version. Pressing the **<NXT>** button allows you to scroll between a screens that say **"MC GDIG"** and **"MC GDIG ZERO OFF"** .

If the speedometer does not have a Zero Off Logo at the bottom of the dial graphic scroll to the screen that says **"MC GDIG"** and press **<SEL>**

If the speedometer has a Zero Off Logo at the bottom of the dial graphic scroll to the screen that says **"MC GDIG ZERO OFF"** and press **<SEL>**

Procedure (continued)

- ❑ Once the **<SEL>** button is pressed the programmer will instruct:



- ❑ As soon as you connect the programming harness to the speedometer the software update process will begin:
 1. The programmer will display **"ERASING"** and a progress bar.
 2. The programmer will display **"PROGRAMMING"** and a progress bar.
 3. The programmer will display **"VERIFYING"** and a progress bar.
- ❑ Upon completion of the update the programmer will display **"SUCCESS !"** and the speedometer will reset.
- ❑ Unplug the programming harness and re-connect the boat harness to the speedometer.
- ❑ Apply power to the boat and verify the following:
 - The speedometer powers up and operates normally.
 - The installed software version in the SETUP \ DIAGNOSTIC TOOLS \ SOFTWARE REVISIONS screen is now V0.20.
 - The Tachometer and 3N1 gauge operates normally.
- ❑ Note: It is not necessary to update the speedometer calibration, roll or pitch calibration, or the Boat Configuration after performing this software update.
- ❑ Turn off the Ignition and Battery Disconnect Switch
- ❑ Re-install the access panel below the dash.
- ❑ Clean up the work area prior to departing the boat.



MY2012 Instrumentation Design Goals

- A Simple Affordable Base Gauge System
- New levels of Marketable Features
- An Optional Color Touch Display





GAUGE SYSTEM: GDIG FEATURES

- Graphical Monochrome Display
- Improved Basic Cruise Control with Rider Presets
- Supports Automatic 2 Axis Control
- Dead Front Back Lit Icons
- Integrated Zero Off Version Available



GAUGE SYSTEM CONTENT:

- 5" Graphical Digital Interface (GDIG) Speedometer
- 3" 3N1 Gauge
(Fuel, Oil Pressure, Coolant Temperature)
- 3" Tachometer
- Blue Back Light



GDIG SPEEDOMETER ICONS:

ALL ICONS

MasterCraft
MasterC_Maristar Xseries

Maristar Xseries

Draft 11
14Apr11



MasterCraft MAIN 2012 SCREENS

CRUISE OFF

Use the select button to pick the desired preset



CRUISE ON

Plug in play depth info

Shows preset that is active



Mode

Auto = Auto tabs

Preset = Auto tabs and tanks

Manual = switch controlled

DEPTH SCREEN

Depth screen goes away when there is no Depth installed



ENGINE INFO SCREEN



BALLAST SCREEN

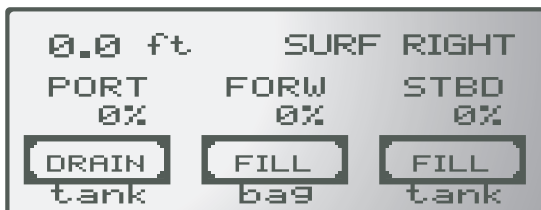

Will display bags or tanks depending on the valve status or NC if valve is not connected to either tank or bag.

TABS SCREEN

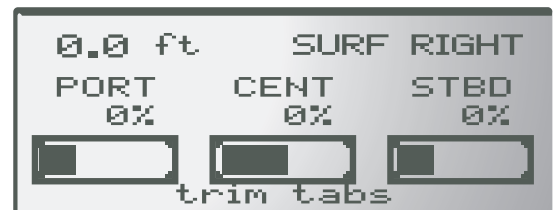

SETUP is accesable when below 800 rpm
press select button to access setup menus.

SETUP MENUS



The SETUP menus are only accessible when the engine RPMs are below 800. The setup menus will all exit automatically after 5 seconds except for the menus that have an EXIT option.

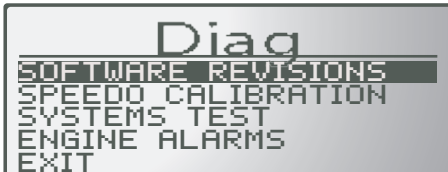

The SOFTWARE REVISIONS selection in the DIAGNOSTIC TOOLS will show the current software revisions for the GDIG (gauges) and the Lenco modules.

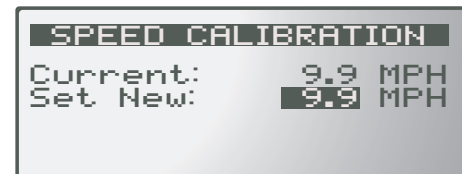

Once in the SPEED CALIBRATION screen has been entered use the up and down buttons to change the speed setting. If no changes are detected after 5 seconds the system will return to the Diag screen.



The SYSTEMS TEST should start an automatic function test of the Gauge system. Pointer should start sweeping.



The ENGINE ALARMS screen will show you any current engine codes being Broadcast on the CAN communication system. When an CHECK ENG alarm appears on the display this screen may give more specific information



Select the EXIT option to return to the main setup screen

SETUP MENUS



The SETUP menus are only accessible when the engine RPMs are below 800. The setup menus will all exit automatically after 5 seconds except the for the menus the have an EXIT option.



The UNITS option will allow the user to select between english or Metric digital data. Use the select button to access the option and the arrow buttons to change the option.



Changing the THREE EVENT option to off will remove the cruise control option from the gauge system.

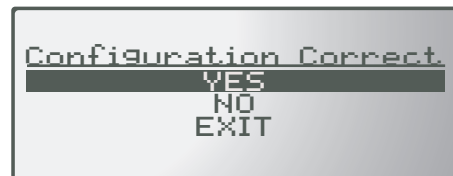
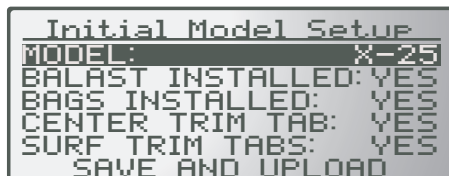

The MODEL & OPTION SETUP is where the boat is loaded with the installed options. Use the select button to enter each option to be adjusted and the arrow buttons to change the information. When all settings have been adjusted arrow to the SAVE AND UPLOAD option and press the select button. A conformation screen will appear to finish the process.



Select the EXIT option to return to the main setup screen