

MASTERCRAFT TRAILER OWNERS MANUAL
MASTERCRAFT TRAILER OWNERS MANUAL
MASTERCRAFT TRAILER OWNERS MANUAL
MASTERCRAFT TRAILER OWNERS MANUAL
MASTERCRAFT TRAILER OWNERS MANUAL
MASTERCRAFT TRAILER OWNERS MANUAL
MASTERCRAFT TRAILER OWNERS MANUAL
MASTERCRAFT TRAILER OWNERS MANUAL
MASTERCRAFT TRAILER OWNERS MANUAL
MASTERCRAFT TRAILER OWNERS MANUAL
MASTERCRAFT TRAILER OWNERS MANUAL
MASTERCRAFT TRAILER OWNERS MANUAL
MASTERCRAFT TRAILER OWNERS MANUAL
MASTERCRAFT TRAILER OWNERS MANUAL
MASTERCRAFT TRAILER OWNERS MANUAL
MASTERCRAFT TRAILER OWNERS MANUAL
MASTERCRAFT TRAILER OWNERS MANUAL

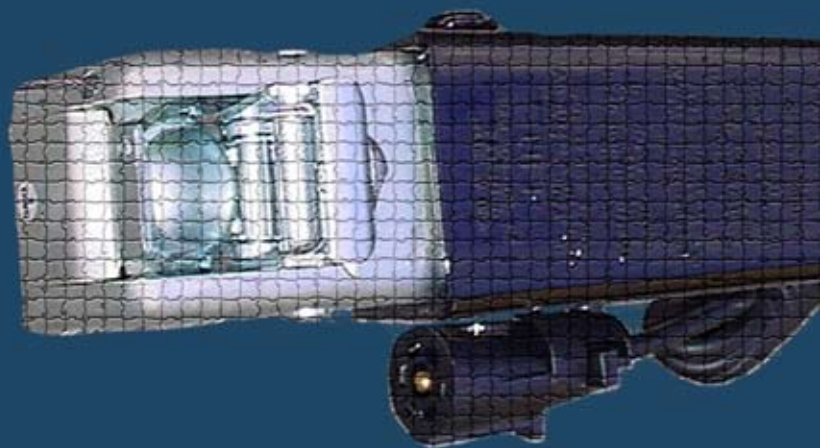

NATIONAL HIGHWAY TRAFFIC SAFETY ADMINISTRATION (NHTSA)

If you believe that your vehicle has a defect which could cause a crash or could cause injury or death, **DO NOT USE THE VEHICLE**. You should immediately inform the National Highway Traffic Safety Administration (NHTSA) in addition to notifying MasterCraft Boat Company. If NHTSA receives similar complaints, it may open an investigation, and if it finds that a safety defect exists in a group of vehicles, it may order a recall and remedy campaign. However, NHTSA cannot become involved in individual problems between you, your dealer, or MasterCraft Boat Company.

To contact NHTSA, you may call the Vehicle Safety Hotline toll-free at 1-888-327-4236, (TTY: 1-800-424-9153); go to <http://nhtsa.safercar.gov>, or write to: Administrator, NHTSA, 1200 New Jersey Avenue SE, Washington, DC 20590. You can also obtain other information about motor vehicle safety from <http://www.safercar.gov>.

The MasterCraft Trailer

CONGRATULATIONS on the selection of a MasterCraft trailer. It is the ideal match for MasterCraft boats. The quality, innovation, selection and value of MasterCraft trailers are recognized as superior in the industry.

Please take a few minutes to read this Manual completely before using the MasterCraft trailer for the first time. It provides substantial information about the trailer. If you still have questions after reviewing this Manual, be sure to contact a MasterCraft dealer. It is important that any and all trailer operators possess as much knowledge as possible.

All information in this Manual is based on the latest product information available at the time of printing. Because of our policy of continuous product improvement, MasterCraft reserves the right to make changes in specifications and models at any time. We also reserve the right to change specifications, parts or accessories at any time without incurring any obligation to equip the same on models manufactured before the date of the change.

Due to changes in specifications, models, parts and/or accessories that may occur after publication of this Manual, the Manual may not reflect those changes. The illustrations used in this Manual are intended only as representative reference views and may not depict actual model component parts. Information about certain components furnished by the suppliers other than MasterCraft is provided separately. This information is available at authorized MasterCraft dealerships.

Note: The information given in this Manual may not be applicable to international rules of the road. If you have any questions, please contact your local authorities.

Visit us on the web at www.mastercraft.com for updates and additional information as it becomes available, as well as for any future potential service information pertaining to the trailer. For specific questions about the MasterCraft trailer, feel free to contact an authorized MasterCraft dealer.



MasterCraft Boat Company LLC, 100 Cherokee Cove Drive, Vonore TN 37885

WARNINGS AND CAUTIONS

Throughout this Manual the terms “WARNING” and “CAUTION” appear, alerting the trailer owner or operator to dangerous or potentially dangerous situations that may arise. Those terms have the following respective meanings whenever they appear herein.



This is the safety alert symbol. It is used to alert you to potential personal injury hazards. Obey all safety messages that follow this symbol to avoid possible injury or death.



WARNING indicates a potentially hazardous situation, which, if not avoided, could result in serious injury or death.



CAUTION indicates a potentially hazardous situation, which, if not avoided, may result in minor or moderate injury.



CAUTION used without the safety alert symbol indicates a potentially hazardous situation which, if not avoided, may result in property damage.

Failure to adhere to and comply with the safety warnings and cautions that appear in this Manual can lead to serious illness, injury or even death and/or damage to the trailer, your boat, the towing vehicle or the property of others. Beyond these warnings, drivers have a personal responsibility to utilize a common sense approach to the towing experience. The consumer is ultimately responsible for a positive and safe involvement in towing and maintaining safety standards for the trailer.

MasterCraft strongly encourages you to cross-reference and read all warnings and cautions set forth in this Manual within the context in which they are presented, by reading and reviewing the entire section of the Manual that relates to each warning and caution. You **MUST** also be familiar with and obey state and local ordinances regarding driving and towing. MasterCraft also recommends a thorough review of applicable insurance coverage and any insurance carrier's restrictions and coverage for towing, as well as a review and adherence to recommendations presented in the tow vehicle's Owner's Manual.



WARNING indicates a potentially hazardous situation, which, if not avoided, could result in serious injury or death.

Before towing this trailer, be sure to read and understand this Manual. (Page 2)

The total weight of the boat, engine, fuel, water and gear must not exceed the trailer's maximum load-carrying capacity. Overloading can cause instability and loss of control while towing, which may result in death, serious injury or property damage. (Page 2)

Do not tow the boat with wakeboards or skis in the boat or ski racks. Loose objects may become disengaged from the trailer and boat. These objects may create a hazard for vehicles following behind the tow vehicle which may result in death, serious injury or property damage. (Page 3)

Improper weight distribution within the boat can cause instability and loss of control while

towing, which may result in death, serious injury or property damage. (Page 3)

If the total weight on the loaded trailer exceeds the load capacity of the hitch on the tow vehicle, then the trailer may break free, which may result in serious injury or death and/or property damage. (Page 5)

The strength rating of EACH length of safety cable must be equal to the trailer's GVWR (Gross Vehicle Weight Rating). (Page 5)

Trailer sway control devices that restrict the operation of the actuator MUST NOT be used. These devices can limit how well the trailer brakes work. (Page 5)

Failure to properly attach the safety cables and brake actuator break-away cable between the trailer and the tow vehicle may result in a run-away trailer if the trailer coupler becomes detached from the hitch. This may cause serious injury or death and/or property damage. (Page 6)

Never tow a trailer without the breakaway cable secured to the tow vehicle. (Page 6)

Maintain a firm grip on the winch handle at all times. Never release the handle when the ratchet level is in the unlocked position with a load on the winch because the handle will spin forcefully under these conditions, which may cause serious injury. (Page 8)

Do not move the trailer to the tow vehicle. When the trailer is moved without a tow vehicle, the brakes do not work. (Page 9)

You must install either the hitch pin that is supplied or a padlock (1/4" or 5/16" shank) into the hitch pin hole before towing to prevent the coupler latch from accidentally opening. (Page 9)

DO NOT tow the trailer with the handle open or if the latch handle will not remain closed. Check to see if the coupler is locked. Lift on the handle without pushing the button to the side. If the handle opens, the hitch ball is not the right size, shape or the latch parts have been damaged. If the latch is damaged, contact an authorized MasterCraft dealer for assistance. (Page 10)



Before each use make certain that all trailer lights are in proper working order, to reduce the risk of serious injury, death and/or property damage. (Page 11)

Maintain the proper torque on the lug nuts attached to the wheel bolts. Failure to do so may result in serious injury or death and/or property damage. An authorized MasterCraft dealer can provide the proper torque specifications (measured in foot-pounds) (Page 11)

Keep the wheel bearings lubricated. Inspect the wheel bearings for proper lubrication before each use. Failure to do so may cause wheel failure and possible wheel loss, which may result in serious injury or death and/or property damage. (Page 11)

Keep tires properly inflated. Inspect each tire's pressure before each use. Refer to the tire sidewall for proper inflation. Failure to maintain the correct tire pressure may result in tire failure and loss of control, which may result in serious injury or death and/or property damage. (Page 13)

Trailer brakes must be maintained in good working condition at all times. Inspect the brake system on a regular basis and verify proper fluid level in the actuator. The loss of adequate brak-

ing could result in serious injury or death and/or property damage. (Page 15)

The breakaway system actuators will apply the trailer brakes if the trailer becomes completely detached from the tow vehicle while under power. Failure to properly connect the breakaway system prior to towing may result in serious injury or death and/or property damage. (Page 15)

The brake lockout bracket must be removed before towing or the trailer brakes will not work. (Page 17)

Failure to engage the locking pin may result in the collapse of the jack stand, which could cause serious injury or death. (Page 18)

Failure to follow maintenance procedures as outlined in this Owner's Manual may result in component failure. Failure may also result in loss of control or other malfunction that could potentially lead to serious injury or death! Such failure is not covered under warranty. (Page 28)



Brake pad replacement should be performed by an authorized MasterCraft dealer. Improper pad replacement may decrease braking effectiveness, potentially resulting in a collision as a result of failure to stop the tow vehicle within an acceptable distance. (Page 28)

Worn rotors must be replaced. Failure to do so may result in brake failure, which may cause serious injury or death. (Page 28)

If any of the following potential problems develop, the trailer must be immediately stopped and the proper corrective action taken before the trailer is placed back in service. Failure to do so may lead to loss of proper trailer braking capability or damage to the trailer and load. (Page 31)

If the latch handle does not close freely, DO NOT tow the trailer until the cause of the problem is located and corrected. Forcing the latch handle closed will make opening the latch handle extremely difficult. (Page 32)



CAUTION indicates a potentially hazardous situation, which, if not avoided, may result in minor or moderate injury.

The breakaway system reset tab must be pushed up after the clip installation and anytime the cable has been pulled. (Page 8)

The brake bleeding procedure should be performed only by skilled mechanics. MasterCraft recommends that it be completed by an authorized MasterCraft dealer. (Page 17)

Important: Do not use brake fluid drained from the brake system to refill the master cylinder reservoir as such fluids contain contaminants from the system that may result in brake failure or costly repairs. (Page 18)

Use great care when walking, standing or loading and unloading boats on or around any launch ramps as some launch ramps may be slippery when wet. (Page 21)

Wet brakes may not hold and/or may cause brakes to have diminished performance characteristics. A few braking applications at a slow speed will help to dry them out. Extra care must be used when braking after brakes have become wet. (Page 22)

CAUTION

CAUTION used without the safety alert symbol indicates a potentially hazardous situation which, if not avoided, may result in property damage.

Loose objects may damage the boat and/or trailer. Such damage would not be covered by the warranty. (Page 3)



WARNING

The maintenance, service and repair procedures described in this Manual should be performed only by trained and authorized factory personnel or dealer technicians. To avoid serious injury or damage to the boat or its components, all steps in each procedure and all safety recommendations should be strictly observed. Failure to follow the procedures and safety recommendations described herein will void any and all warranties and may cause personal injury or damage to components and adversely affect the operation of the trailer. **CONSUMERS SHOULD NEVER ATTEMPT TO UNDERTAKE THE MAINTENANCE AND REPAIR PROCEDURES DESCRIBED IN THIS MANUAL.**

TABLE OF CONTENTS *MasterCraft*

NATIONAL HIGHWAY TRAFFIC SAFETY ADMINISTRATION

(NHTSA) Statement.....	i
MasterCraft Trailer.....	i
Warnings and Cautions	ii
Quick Tips.....	1
Introduction.....	2
A Proper Match	2
Load Carrying Capacity	3
Weight Distribution	3
The Trailer Hitch	4
Safety Cables	5
Breakaway Cable.....	6
Trailer Winch Assembly	8
Warnings at Tongue	9
How to Attach the Trailer.....	9
Lights.....	11
Wheels and Hubs.....	11
Lug Nuts or Wheel Bolts.....	12
Tires.....	13
Axles & Lubrication	14
Braking System	14
Brake Lockout Bracket.....	16
Manual Bleeding of Brakes.....	17
Trailer Jack.....	18
Tie-Downs.....	18
Hitching Up.....	19
Trailer Tips & Techniques	20
Launching.....	21
Towing Requirements	22
Trailer Tips.....	23
Trailer Checklist.....	23
Limited Warranty Statement.....	24
Maintenance.....	28
Troubleshooting.....	31

QUICK TIPS

MasterCraft

Here are some quick tips for maintaining the trailer in excellent condition.

CHIPS IN THE PAINT, especially on the axles and frame, result when these surfaces are subjected to repeated or severe hits by external objects. Usually, these are gravel or asphalt chips thrown up by the rear tires of the tow vehicle. Over time, rust may develop where paint has been chipped away, and this is **not** covered by the Limited Warranty for the trailer. To avoid this situation, consider attaching mud flaps behind the tow vehicle's rear tires. Exceptional care should be taken to travel as slowly as practical when traveling on gravel or other loose surfaces.

TO ENSURE PROPER OPERATION OF THE TRAILER JACK, wipe it down and lubricate it on a regular basis.

IF THE TRAILER IS BACKED INTO SALT WATER, you must completely and thoroughly wash the trailer in fresh water to retard rusting. Salt water is very corrosive, even on galvanized trailers, and can corrode the braking system as well. Exposure to salt water can also cause brake pads to stick and malfunction.

CHECK THE BRAKING SYSTEM in the spring and again in the fall, along with the wheel bearings. If there is anything that appears to be worn or leaking, take the trailer to an authorized MasterCraft dealer for a check and possible repair.

TOW VEHICLES MUST ALWAYS APPROACH THE TRAILER slowly prior to being hitched to the trailer. This allows the operator to retain greater control. Hard impact with the trailer or improper alignment on the trailer can result in damage to the boat, the trailer, or both, and this is not covered under warranty. Also, if the trailer is equipped with the Boat Buddy System, a hard hit against it could cause damage, which is also not covered by warranty.

THE TOW VEHICLE MUST HAVE A SEVEN-WIRE CONNECTOR in order for disc brakes and the trailer lights to function properly. It is important to properly connect the seven-wire connector on the trailer to the seven-wire connector on the tow vehicle.

The correct method for determining the load limit is to:

LOCATE THE STATEMENT, "The weight of cargo should never exceed ___ kg or ___ lbs.," on the trailer tongue. (This figure equals the available amount of cargo and luggage load capacity.)

DETERMINE THE COMBINED WEIGHT of luggage and cargo being loaded on the vehicle. (That weight may not safely exceed the available cargo and luggage load capacity.)

WALK AROUND: The majority of potential roadside issues are eliminated by a walk-around visual inspection. This should be done after hitching up and at each fuel or rest stop. A quick visual check of: the coupler, safety cables, emergency brake cable, wiring connector, tie-downs, and tires; and for: any obvious fluid leaks; unusually hot brakes or hubs; or damage by road hazards. Make a point to pay particular attention to the right (starboard) side of the trailer, as this is most typically where road hazard damage occurs.

These are some brief tips for maneuvering with a trailer attached to a tow vehicle:

WHEN BACKING UP, place your hand at the bottom of the steering wheel. To turn left, move your hand left. To turn right, move your hand right. Back up slowly. Because mirrors cannot provide all of the visibility you may need when backing up, have someone outside at the rear of the trailer to guide you whenever possible. Use slight movements of the steering wheel to adjust direction. Exaggerated movements will cause greater movement of the trailer. If you have difficulty, pull forward and realign the tow vehicle and trailer and start over.

WHEN PARKING, try to avoid parking on grades. If possible, have someone outside to guide you as you park. Once stopped, but before shifting into Park, have someone place blocks on the downhill side of the trailer wheels. Apply the



parking brake, shift into Park, and then remove your foot from the brake pedal. Following this parking sequence is important to be sure your vehicle does not become locked in Park because of extra load on the transmission. For manual transmissions, apply the parking brake and then turn the vehicle off in either first or reverse gear.

WHEN UNCOUPLING THE TRAILER, place blocks at the front and rear of the trailer tires to ensure that the trailer does not roll away when the coupling is released.

AN UNBALANCED LOAD may cause the tongue to suddenly rotate upward; therefore, before uncoupling, place jack stands under the rear of the trailer.

IF A TRAILER SEEMS HARD TO PULL or sways to one side, a brake rotor may not be rotating freely. If this appears to be the problem, immediately contact your authorized MasterCraft dealer for assistance. Ignoring this symptom could result in brake failure.

INTRODUCTION *MasterCraft*

With the purchase of a new MasterCraft trailer, custom-built to integrate with a MasterCraft boat, value has been added to the boating experience. Thousands of recreational waterways are now available.

As the manufacturer, MasterCraft has provided a vehicle designed specifically for many years of attractive, trouble-free service. Now, it is up to the owner and/or operator to give it proper care and maintenance to be sure it will continue to perform safely and satisfactorily.

The purpose of this section of the Manual is to help owners and operators do just that. Please read and follow the warnings and instructions carefully. Also, because all trailers are not exactly alike, be sure to read and comply with any warnings and additional information supplied by MasterCraft and parts suppliers within the owner packet. It's the best way to obtain peak performance.



WARNING

Before towing this trailer, be sure to read and understand this Manual.

A PROPER MATCH *MasterCraft*

The key to carefree boat trailering is the proper match of boat to trailer. This proper match is only one reason why the MasterCraft engineering staff has designed the trailer to carry the full weight of the boat, engine and a reasonable amount of gear. It also provides the proper support for the boat hull during storage.



WARNING

The total weight of the boat, engine, fuel, water and gear must not exceed the trailer's maximum load-carrying capacity. Overloading can cause instability and loss of control while towing, which may result in death, serious injury or property damage.

LOAD-CARRYING CAPACITY



Check the certification label attached to the front left side of the trailer. It will show the maximum load-carrying capacity of the trailer. It will also show the Gross Vehicle Weight Rating (GVWR). The Gross Vehicle Weight Rating ("GVWR") is the estimated total weight of a road vehicle that is loaded to capacity, including the weight of the vehicle itself. Therefore, the maximum load-carrying capacity of the trailer is the GVWR, less

the weight of the empty trailer. *Be sure that the total weight of the boat, engine, gear and trailer do not exceed the GVWR.*

NOTE: The Gross Vehicle Weight Rating ("GVWR") is the estimated total weight of a road vehicle that is loaded to capacity, including the weight of the vehicle itself. Therefore, the maximum load-carrying capacity of the trailer is the GVWR less the weight of the empty trailer.

Be especially careful to avoid overloading the trailer by putting heavy baggage, camping gear, etc. inside the boat.

Do not tow the boat with a water-filled bladder or with water in the ballast tanks. Empty the contents or the tongue weight will be incorrect. Towing with water-filled bladder(s) may not only cause the total weight limits for the trailer to be exceeded but may also result in the improper distribution of the weight on the trailer, thereby making towing difficult and/or causing instability when towing, which can be very dangerous to the driver, any passengers and to other motorists.

Do not tow the boat with wakeboards left on the board racks. Doing so may void the warranty and cause damage to the boat or to vehicles following behind, as boards and/or racks may become disengaged.



Do not tow the boat with wakeboards or skis in the boat or ski racks. Loose objects may become disengaged from the trailer and boat. These objects may create a hazard

for vehicles following behind the tow vehicle which may result in death, serious injury or property damage.



Loose objects may damage the boat and/or trailer. Such damage would not be covered by the warranty.



Improper weight distribution within the boat can cause instability and loss of control while towing, which may result in death, serious injury or property damage.

WEIGHT DISTRIBUTION

Improper weight distribution can cause a boat trailer to fishtail (sway from side to side) as it moves down the highway, putting excessive strains on both trailer and towing equipment, which increases gas consumption and may potentially cause an accident. The most effective way to guard against fishtailing is to make sure the weight load on the trailer is properly distributed.



It is extremely important that a minimum of five percent (5%) and a maximum of ten percent (10%) of the total weight on the trailer be felt at the trailer coupling ball when the tongue is parallel to the ground. A bathroom scale can be used for this determination.

For example, if the gross weight of the trailer, boat and gear is 3,000 pounds, the weight on the tongue should not be more than 300 pounds, but not less than 150. (*Some auto manufacturers say that tongue weight should not exceed 200 pounds when using a weight-carrying, bumper-mounted*

hitch with full-sized cars.) Check the tow vehicle owner's manual.

The importance of an adequate download on the hitch ball cannot be over-stated.

THE TRAILER HITCH *MasterCraft*



There are two basic types of trailer hitches: a weight-carrying hitch and a weight-distribution hitch. A weight-carrying hitch is recommended for use with a MasterCraft boat and trailer. However, weight-distributing (equalizing) hitches may be used. The chain must be vertical (straight up and down) under the pulling load where the actuator is extended. Excessive tongue weight beyond the actuator rating must be avoided as it will reduce the brake performance and could damage the actuator. Always follow the hitch manufacturer's instructions. Before deciding upon which type of hitch to use, also consult the automobile manufacturer on recommendations for the tow vehicle.

Be sure that the total weight of the trailer-boat rig does not exceed the hitch's load capacity.

The maximum weight it can handle is stamped on the hitch. Also, be sure the hitch ball is the correct size to match the coupler on the trailer. The correct ball diameter is marked on the trailer coupler. The hitch should also provide a place for attaching the trailer's safety cables—two rings or holes on either side of the hitch ball.

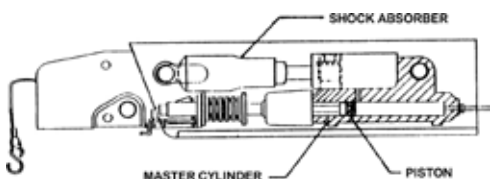

A truck or van using a step bumper as the hitch platform will need to have safety cable attachments such as eye-bolts, as well as a hitch ball, which has been installed according to the Society of Automotive Engineers; SAE J684 Standard. Installing a light or heavy-duty hitch can be a major undertaking. The hitch and its installation must meet the SAE J684 Standard. It is recommended that the job be done by a professional. An authorized MasterCraft dealer can offer advice.

To ensure that the boat is riding properly on the trailer supports, the trailer should be in a level position when hitched to the tow vehicle. The recommended height of the hitch ball, according to the National Marine Manufacturer's Association ("NMMA"), is 18 to 20 inches to the top of the ball from the ground. More importantly, failure to adjust to this height may prematurely activate the surge brakes.

This can be corrected in a number of different ways. For example, air-pressure adjustable shock absorbers may be installed on the tow vehicle, or switch from a weight-carrying hitch to a weight-distributing hitch. Again, consult with the tow-vehicle's dealer or manufacturer.

In general, for Class 3 rigs (3,500 to 5,000 lbs.), a two-inch (2") ball is the requirement. For Class 4 (5,000 to 10,000 lbs.), a ball of either 2" or 2-5/16" will be required.



If the total weight on the loaded trailer exceeds the load capacity of the hitch on the tow vehicle, then the trailer may break free, which may result in serious injury or death and/or property damage.

For proper tow vehicle and trailer hook-up and towing performance, the tow vehicle and trailer must be level (parallel) to the ground after hitching up. If the trailer is not level, equipment is available to raise or lower the hitch ball. A weight-equalizing hitch or load support suspension equipment may also be required to keep the tow vehicle level while properly loading each trailer axle.

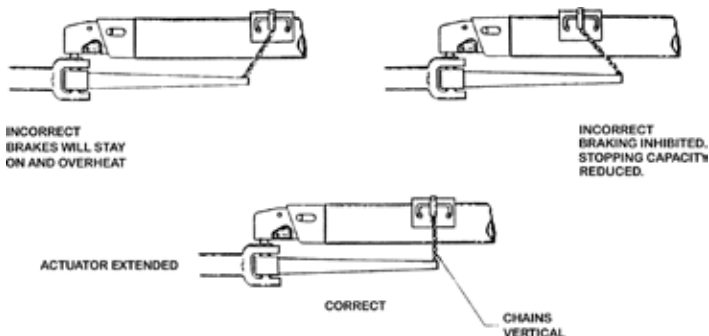

SAFETY CABLES

MasterCraft

The safety cables on a MasterCraft trailer provide added security that the trailer will not become detached from the tow vehicle when underway. These cables conform to the Society of Automotive Engineers (SAE) J684 standard for trailer coupling and hitches—automotive type. If it ever becomes necessary to replace these cables, ensure that the replacement cables meet this standard.



Failure to properly attach the safety cables and brake actuator break-away cable between the trailer and the tow vehicle may result in a run-away trailer if the trailer

coupler becomes detached from the hitch. This may cause serious injury or death and/or property damage.



WARNING

The strength rating of EACH length of safety cable must be equal to the trailer's GVWR (Gross Vehicle Weight Rating).



WARNING

Trailer sway control devices that restrict the operation of the actuator **MUST NOT** be used. These devices can limit how well the trailer brakes work.

Before each trip, ensure that the proper cables are correctly attached between the tow vehicle and the trailer.

Secure the breakaway cable to the bumper or frame of the tow vehicle as close to center as possible but do not attach to the safety cables.

As noted above, the trailer hitch should provide a place for attaching safety cables, through holes or rings on both sides of the hitch ball. It is strongly recommended, and most states require, that the cables be criss-crossed under the trailer tongue (e.g., the cables on the left side of the trailer tongue should be attached to the hole or ring on the right side of the hitch ball, and the right side cable should be attached to the hole or ring on the left side of the hitch ball). This will prevent the trailer tongue from dropping to the road if the trailer coupler separates from the hitch ball.



The cables should be rigged as tightly as possible, with just enough slack to permit tight turns. If for any reason it becomes necessary to replace a safety cable, do not substitute with any part other than a genuine MasterCraft cable.

Note that late-model trailers are equipped with a surge brake break-away cable. This should be attached to the tow vehicle, making sure there is enough slack for tight turns.

BREAKAWAY CABLE *MasterCraft*



Secure the breakaway cable to the bumper or frame of the tow vehicle as close to the center as possible but do not attach it to the safety chains. The cable **MUST** hang clear of the trailer tongue and be long enough to permit sharp turns without pulling the cable and will not be applied unless the safety chains fail. Do not loop an S-hook over the break-away cable to attach it.



WARNING

Never tow a trailer without the breakaway cable secured to the tow vehicle.

If the breakaway cable is accidentally pulled and the brakes applied, determine why it happened and fix the problem. Inadvertent setting of the brakes by pulling the breakaway cable is a common mistake. To prevent light pulls from accidentally setting trailer brakes a small metal clip has been installed on breakaway cables in front of the indicator bead. The clip will not inhibit the action of the breakaway mechanism during actual breakaway conditions. However, if breakaway should occur, the clip will be destroyed and should be replaced. Spare clips are available through authorized MasterCraft dealers.

To retract the breakaway cable, slide the coupler fully forward and push up on the push rod release bracket located on the underside and behind the hitch ball socket. This allows the bead to retract into the actuator. This releases the trailer brakes. Install a new clip on the breakaway cable in front of the bead.

Checking and resetting the breakaway cable:

If pushing up on the bracket does not release the brakes or it is hard to push, insert a pry bar into the 5/16" hole behind the bracket. Use the pry bar to (gently) stroke the push rod backwards and relieve the load on the bracket. Push up on the bracket and hold it up while

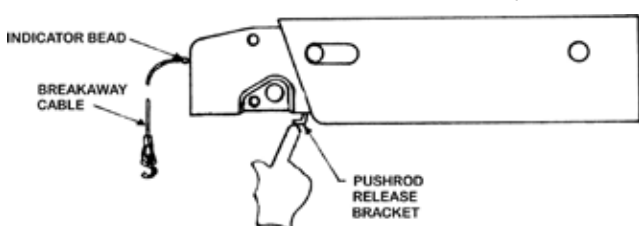

releasing the pry bar. The push rod release bracket should now move freely and brakes should be released.

Check to be certain the actuator is reset. Extend the actuator fully. Remove

the cap from the top of the actuator and pull the plug from the top of the reservoir cover. While looking at the fluid in the reservoir, manually compress the actuator. In the first 1/8" of coupler movement the fluid in the reservoir should splash or ripple slightly. If it does, the actuator is working properly.

Stroking the push rod to release the brakes:

If the brakes cannot be released using the method described above, or if the push rod release bracket will not move, it is damaged beyond serviceability. Contact an authorized MasterCraft dealer for assistance and replacement parts.

How to install the breakaway cable clip:

The breakaway cable clip is installed on the breakaway cable to prevent inadvertent pressurization of the trailer brakes if the cable is lightly pulled by accident. If the breakaway cable is pulled during an emergency situation, the clip will be destroyed. The breakaway system must be reset by pushing up on the tab located under the coupler and the clip must be replaced.

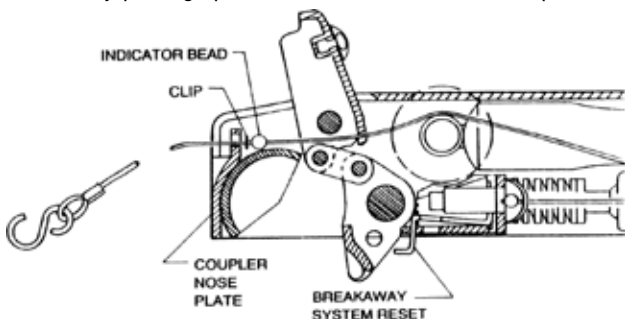

To install a new clip, open the latch handle and pull enough cable out of the coupler body to make the installation of the clip easier. The clip must be installed on the cable in front of the indicator bead as shown in the illustration. (NOTE: Some couplers do not require a clip. Verify

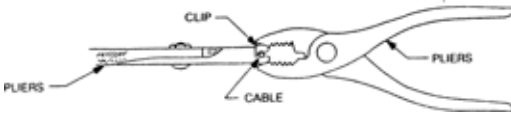

with your authorized MasterCraft dealer whether your model has the clip.) Hold the clip with a set of pliers and insert over the cable. Use a second set of pliers to gently close the opened end of the clip. The clip should be free to move on the cable.



The breakaway system reset tab must be pushed up after the clip installation and anytime the cable has been pulled.

TRAILER WINCH ASSEMBLY



Maintain a firm grip on the winch handle at all times. Never release the handle when the ratchet level is in the unlocked position with a load on the winch because the handle will spin forcefully under these conditions, which may cause serious injury.

Prior to each use of the winch, check for the proper ratchet operation. Do not use the winch if it is damaged. Seek immediate repairs.

Never use the winch handle as a handle for pulling or maneuvering the entire trailer or other equipment. Never pull on the winch handle against a locked ratchet.

Never exceed the rated capacity of the winch. Excessive loads may cause premature failure.

Never apply a load on the winch with the strap fully extended. Keep at least two full turns of the strap that's on the reel.

Inspect the condition of the winch strap. Using a damaged or worn winch strap may result in serious injury or damage.

It is not recommended to use the winch as the sole method for loading the boat onto the trailer. However, it is a satisfactory assistant in the event of engine power loss.

Check the winch straps frequently. The strength in these can deteriorate from exposure to weather, ozone and ultraviolet light. If a strap becomes frayed or worn, replace it immediately with a new one.

A heavy grease should be applied to the gears to provide a free-running drive and to minimize the effort you have to expend to crank the boat onto the trailer.

The winch is intended solely as an aid to loading the boat on the trailer. It is not intended or adequate to be the sole means of holding the boat in place while trailering. Proper tie-downs fore and aft must be used.

WARNINGS AT TONGUE



Read and adhere to all warning labels, especially those that appear on the pivot tongue.

Ensure the swing tongue is folded fully forward, the pivot pin is installed, and the keeper pin is installed in the bottom of the pivot pin before towing. When folding the swing tongue open or forward to the fully closed position, be sure that the brake hose is not kinked or pinched in any way. A pinched or kinked brake hose will cause the brakes to drag and

overheat. The pins and fasteners are special items. Adjustment of the swing tongue or any component replacement should be performed by your authorized MasterCraft dealer.

HOW TO ATTACH THE TRAILER



To connect the trailer to the tow vehicle, open the coupler mechanism (instructions below). When necessary, raise the trailer jack. Slowly back up the tow vehicle until the hitch ball is under the coupler. This is easier with a second person standing beside the trailer and guiding the driver.



Do not move the trailer to the tow vehicle. When the trailer is moved without a tow vehicle, the brakes do not work.

If the latch accidentally opens, the coupler could detach from the hitch ball. The hitch pin should fit easily into the hole. If it does not, the coupler latch is not completely closed. Every time the coupler is attached to the hitch ball, be sure the coupler completely covers the hitch ball and the lift handle will not open without pushing the push button on the side or pulling up on the trigger. If the hitch pin is damaged or lost,

contact an authorized MasterCraft dealer for a free replacement pin.



You must install either the hitch pin that is supplied or a padlock (1/4" or 5/16" shank) into the hitch pin hole before towing to prevent the coupler latch from accidentally opening.



To open the coupler:

Remove the hitch pin from the hole in the side of the coupler. Push the button on top of the handle to the side. While holding the button to the side, raise the handle by lifting the front with two fingers. The coupler should unlatch easily. If not, the ball may be over-sized or egg-shaped, or foreign matter could be lodged in the coupler ball socket, or the coupler is pushing on the hitch ball. Check to make sure the wheel on the tongue jack is raised or that you are not parked downhill. Correct these conditions, then try to open the handle. Also if the tongue jack is forcing the front of the trailer up or the trailer is pushing against the tow vehicle, it can also result in failure of the coupler to open properly.

To close the coupler:

Place the coupler over the ball, lower the coupler and close the handle. An audible “click” will be heard. The handle should close with finger pressure. If the handle will not close freely, the ball is not fully inserted into the socket, it is over-sized or egg-shaped. **DO NOT FORCE THE HANDLE.** If necessary, replace the ball with a quality unit that meets SAE specifications. Insert the hitch pin into the hole on the side of the coupler.



DO NOT tow the trailer with the handle open or if the latch handle will not remain closed. Check to see if the coupler is locked. Lift on the handle without pushing the button to the side. If the handle

opens, the hitch ball is not the right size, shape or the latch parts have been damaged. If the latch is damaged, contact an authorized MasterCraft dealer for assistance.



LIGHTS

MasterCraft



Before each use make certain that all trailer lights are in proper working order, to reduce the risk of serious injury, death and/or property damage.



The MasterCraft trailer harness was specifically designed to mate with O.E.M. automotive equipment. This harness is designed to disengage the trailer brakes with the use of the tow vehicle's O.E.M. harness.

Note: See an authorized MasterCraft dealer if the tow vehicle does not have the correct trailer harness.

Here are a few things to do to keep the trailer

lighting system in good working order:

- Be sure the white ground wire is properly connected to the trailer frame. Replace any parts that are damaged or worn.
- A small amount of waterproof grease on the plug contacts and light bulb bases will help prevent rust and corrosion.
- Before every trip, check for burned out or broken bulbs, cracked or broken light lenses, etc.

WHEELS AND HUBS

MasterCraft

Because they are often exposed to water, trailer wheels and tires require more attention than the wheels on a family vehicle. The three major items to check are lug nuts, lubrication and tire pressure.



Maintain the proper torque on the lug nuts attached to the wheel bolts. Failure to do so may result in serious injury or death and/or property damage. An authorized MasterCraft dealer can provide the proper torque specifications (measured in foot-pounds).



Keep the wheel bearings lubricated. Inspect the wheel bearings for proper lubrication before each use. Failure to do so may cause wheel failure and

possible wheel loss, which may result in serious injury or death and/or property damage.

Aluminum wheels also require attention to routine maintenance, particularly in keeping them clean. Failure to do so may result in damage that is not covered by warranty.

The trailer and wheels should be washed weekly during boating season, and after every use if the trailer has been submerged in salt or brackish water. Use a soft brush,



mild detergent and/or mild degreaser. A quality spray-on wheel cleaner may also be used. Ensure that any product used is specifically indicated for use on aluminum. (Many cleaners are too harsh and will result in pitting or other damage to the wheel surface.) Many car washes use strong chemicals and should be avoided when that is the case.

Removing road film, contaminants and brake dust (all of which retain moisture) is critical to ensuring that the wheels will retain their luster and quality finish for a long period of time. Any exposure to a hard winter climate, particularly road salt and/or chemicals, requires immediate cleaning just the same as submersion in salt water requires immediate cleaning.

NEVER CLEAN HOT WHEELS. Allow wheels to cool or cool them with running water. If the wheels are too hot, significant damage can occur to the wheels.

It is also important to seal the wheels with a sealant that reduces static and resists brake dust. Check at an automotive supply store for an appropriate sealant.

LUG NUTS OR WHEEL BOLTS

Loose wheel mounting nuts (lug nuts) can cause more than just an annoying wheel wobble—it's possible to lose a wheel. Before each trip check for loose or missing lug nuts/wheel bolts.

When tightening the lug nuts, use the correctly sized wrench. The wrong size can round off the lug nuts and render them useless. If you lose a lug nut, replace it promptly. The correct size varies with different models, so verify the proper size with an authorized MasterCraft dealer.

Take special care to ensure that the replacement lug nut is the correct type. While the threads of the lug nut may match, it may be a size that does not hold the wheel securely against the hub, even when fully tightened. Be certain a replacement lug nut is an exact match for the original.

- Ensuring that lug nuts on trailer wheels are tight and properly torqued is an important responsibility that trailer owners and users need to be familiar with and practice. Inadequate and/or inappropriate lug nut torque (tightness) is a major reason that lug nuts loosen during use. Loose lug nuts can rapidly lead to a wheel separation, with potentially serious safety consequences.
- Check the lug nut tightness often, especially during the first few hundred miles of the trailer's use. You should always check torque at the beginning of any long trip and every time a wheel is removed.
- You must use a torque wrench to accurately indicate the amount of torque that you are applying to the lug nut. Four-way wrenches, ratchets, and similar tools can be useful for short-term emergency repairs but are not appropriate tools for accurately checking lug nut torque.
- Keep a record of the date and approximate mileage when the lug nut torque is checked. Note any lug nut(s) that lost torque. Investigate the reason(s) if the lug nut torque is not maintained over more than one re-torque application because this indicates there is something potentially wrong with the lug nuts, nut studs, wheels and/or hubs and that should be corrected.
- Contact an authorized MasterCraft dealer immediately if any persistent lug nut loosening (or any other lug, wheel or axle problem) occurs.
- In the event of a wheel separating from the trailer during use, notify an authorized MasterCraft dealer. Seek prompt professional assistance in assessing the trailer and its

gear, and retain but do not re-use involved lug nuts, wheels and studs. Do not repair or service the trailer yourself. Instead, call a trained technician.

- Use the following pattern to tighten lug nuts. On first torquing pass tighten to 45 ft.-lbs. On second pass tighten to 70 ft.-lbs. On third pass tighten to 90 ft.-lbs. On fourth pass tighten to a reading between 110 ft. lbs-120 ft.-lbs.



TIRES

MasterCraft



The most common cause of trailer tire trouble is under-inflation. It is important, therefore, to always maintain correct air pressure as indicated by the tire manufacturer on the tire's sidewalls. Always check the air pressure when the tires are cold. Tires heat up and the air pressure increases after traveling short distances.

When trailer tires become worn or damaged, replace them with new tires. An authorized MasterCraft dealer can help you.

For safety and convenience, inflate tires to the air pressure indicated on the sidewall of the tire, but always carry a spare wheel and tire in case of unexpected or sudden issues with a tire.

During times of storage, maintain the proper tire inflation, shield tires from UV rays, and relieve the load on the tires by supporting the trailer frame with concrete blocks or jack stands.



Keep tires properly inflated. Inspect each tire's pressure before each use. Refer to the tire sidewall for proper inflation. Failure to maintain the correct tire pressure may

result in tire failure and loss of control, which may result in serious injury or death and/or property damage.

The original-purchase tires that come equipped on the MasterCraft trailer were selected for durability as well as comfort and are matched to the trailer requirements. Over time, as with all tires, there will be wear and eventually replacement will be necessary. At that time,

it is strongly recommended that the owner not mix radial and bias tires as it may affect the trailer/tow vehicle handling and safety. MasterCraft dealers offer replacement tires; if the owner chooses to go elsewhere, be certain that the replacement tires meet the manufacturer's requirements and integrate with any tires remaining on the trailer.

AXLES AND LUBRICATION



The trailer is equipped with a Trailer Buddy Axle utilizing the VAULT bearing protector with specially formulated Hybrid Oil™ lubricant. The VAULT combines the benefits of oil and grease, lubricating and protecting the wheel bearings in a sealed pressurized chamber impenetrable by outside elements.

The system has a number of unique features not found on conventional trailer axles. Every possible leak point on the front and rear of the hub is sealed. The slight (3-6 psi) pressure within the VAULT system generated inside the hub chamber will not damage the inner oil seals. The pressure inside the hub is needed to keep water out of the hub chamber when the hub is

submerged underwater during launch and retrieval.

Inspection or replenishment of the lubricant is not required as part of the routine maintenance. At ambient temperatures the oil is thick, with a viscosity approaching grease. As the bearing temperature rises during towing, the oil thins out, replenishing the bearings with lubricant and dissipating heat. For optimal performance, only UFP's Hybrid Oil Lubricant should be used in this system.

Adding or changing the lubricant in the VAULT system is neither necessary nor recommended during the first five years of service. After that time, the maintenance requirements should be undertaken only by an authorized MasterCraft dealer and only the lubricant specified above should be used.

If the bearings need to be adjusted or replaced, the work should be done only by an authorized MasterCraft dealer. Failure to contact MasterCraft for pre-approval during the warranty period will void the warranty.

The wheel bearings have been precisely torque-set at the factory. To assure the bearings are in good working order, check the bearing adjustment at least once a year by following this procedure: Jack up one side of the trailer. (Be certain to use jack stands and check the trailer wheels to keep the trailer from moving during the inspection.) Grip the edge of the tire and see if it can be rocked or moved. If the outer edge of the tire moves more than 1/8", the bearings may need to be readjusted.

A slight amount of oil seepage at the rear seal is normal and necessary to lubricate the wiper lip of the seal for long life and sealing contaminants out. If excessive leakage is occurring, however, contact an authorized MasterCraft Dealer for assistance.

BRAKING SYSTEM *MasterCraft*

Disc brakes offer several advantages over drum brakes. Disc brakes have improved resistance to fade on downhill grades. They are self-adjusting, so as the pads wear, braking efficiency is not reduced. This type of brake also recovers quickly after being submerged. They also require less maintenance, are easier to flush out, and are less susceptible to water-induced corrosion.

The trailer's brakes are designed to energize automatically when the tow vehicle's brakes are applied. These are known as "surge brakes." (Note: Some jurisdictions do not allow surge brakes. Always check within the locality in which you will be towing.) When the vehicle slows down or stops, the forward momentum (surge) of the trailer against the hitch ball develops hydraulic pressure in a master cylinder inside the trailer brake actuator. Hydraulic lines are used to transfer pressure to the brakes and engage them.

In most states, trailers with a Gross Vehicle Weight Rating (GVWR) of 1,500 pounds or more are required by law to have brakes on all wheels. (Auto manufacturers generally recommend brakes even with lighter trailers.)



Trailer brakes must be maintained in good working condition at all times. Inspect the brake system on a regular basis and verify proper fluid level in the actuator.

or. The loss of adequate braking could result in serious injury or death and/or property damage.

The trailer is equipped with a hydraulic brake actuator. Trailer brakes will automatically apply whenever the tow vehicle's brakes are applied. Stopping (deceleration) force is developed in direct proportion to the stopping force generated by the tow vehicle.

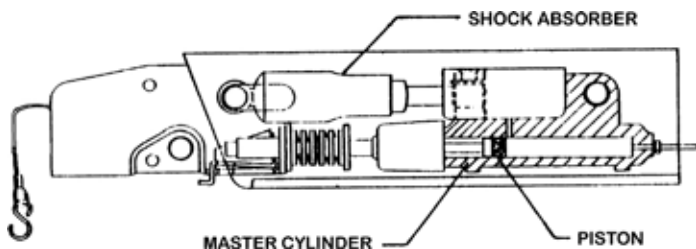

The breakaway system actuators will apply the trailer brakes if the trailer becomes completely detached from the tow vehicle while under power. Failure to properly

connect the breakaway system prior to towing may result in serious injury or death and/or property damage.

The breakaway cable is a line of defense at separation. Before the breakaway cable is pulled, the coupler must become detached from the hitch ball and then the safety chains fail. At this time the breakaway cable is pulled, which applies a braking force to the trailer. Note that the breakaway system is not intended to lock up the trailer brakes after separating from the tow vehicle but rather to apply just enough braking force to keep the trailer from free-wheeling. The breakaway system must be reset manually after it has been activated.

DO NOT USE THE BREAKAWAY SYSTEM AS A PARKING BRAKE.

A surface rust will build up on the rotor brake surface if the trailer isn't used for a week or more. The brake pads will wipe off the rust in the first few miles of travel. If the trailer has been idle for several months, or it has been frequently submerged in salt water and the



brakes not flushed out, severe corrosion can occur.

Try the brakes before each trip. On a regular basis, have the brake linings inspected, necessary adjustments made and any damaged or worn parts replaced by an authorized MasterCraft dealer.

Wet brakes usually do not hold especially well. If the wheels have been in water, several brake applications at slow speeds should dry them out. If the wheel assemblies have been submerged in salt water, it is important to flush the rotors and calipers thoroughly with fresh water to minimize subsequent corrosion.

- If the stopping capacity does not meet expectations, have the tow vehicle and the trailer brakes checked for proper operation. The trailer brakes should be inspected by an authorized MasterCraft dealer.

- Review the tow vehicle manufacturer's recommen-

ations and instructions for towing.

- If the brakes are hot, before launching it is a good idea to allow the brakes to cool first. The sudden change in temperature when submerging very hot calipers and rotors stresses all the parts and could cause damage.
- If you are unable to back-up, check the electronically operated back-up valve on the actuator, which is connected to the tow vehicle back-up lights. When energized, the valve opens and prevents pressure build-up in the system. When it is energized by shifting the tow vehicle into reverse, you should hear a noticeable "click" sound. If you don't, check that the electrical connection between tow vehicle and trailer is secure.
- When parking the trailer, be sure the actuator is fully extended. This position relieves pressure on the brakes. Actuators sometimes freeze up in the compressed position from corrosion. This causes the brakes to drag and overheat during subsequent outings.

BRAKE LOCKOUT BRACKET



When backing up, the coupler will move back and apply the trailer brakes. The brakes will apply at different levels depending on how fast you back up, the type of brakes the road or surface, and the angle the trailer is at. Some trailers with disc brakes need an electrical solenoid control to allow the trailer to back up. This control is wired to the back-up lights on the tow vehicle and when the tow vehicle is put into reverse, this control does not allow the trailer brakes to apply.

A simple lockout has been included with this Owner's Manual (it is not installed on the trailer as it is used only when needed and should otherwise not be left on the trailer). When inserted, this bracket will keep the coupler from moving back and applying the brakes. It should be used when backing over soft ground or up a hill. Use it as follows:

1. Place the brake lockout into the slot behind the roller pin on the side of the actuator.
2. Slide the brake lockout completely forward in the slot. A washer will keep the brake lockout from falling out while backing up.

When pulling the trailer forward and the actuator extends, the brake lockout should fall out of the slot. This ensures that the actuator will function when stopping.



The brake lockout bracket must be removed before towing or the trailer brakes will not work.

MANUAL BLEEDING OF BRAKES



The following procedure should be performed only by skilled mechanics. MasterCraft recommends that it be completed by an authorized MasterCraft dealer.

Check that all hydraulic fittings are secure. Read and understand all instructions before starting. Two people are required for manual bleeding.

1. Remove the master cylinder reservoir plug and fill the reservoir with brake fluid. Use either DOT 3 (preferred) or DOT 4 automotive brake fluid. Follow the instructions on the brake fluid container. Avoid shaking the brake fluid container and pour fluid slowly to minimize air entrapment. Let the fluid in the reservoir stand until it is completely free of air bubbles.
2. **IMPORTANT:** Before bleeding the brake lines, bleed the actuator master cylinder. Insert a screwdriver through the hole in the bottom of the inner member and use short strokes to pry on the push rod (while holding the safety release bracket up) until no air bubbles are seen coming from the small orifice hole in the bottom of the master cylinder reservoir.
3. Start the bleeding procedure on the brake farthest from the master cylinder.
4. At the brake assembly, connect a transparent bleeder hose to the bleed screw fitting on the wheel cylinder and submerge the free end into a container partially filled with brake fluid. Do not reuse this fluid.
5. The first person should stroke the push rod slowly while holding the safety release bracket up. The second person opens the bleed screw fitting. He then closes the bleed screw fitting BEFORE the first person SLOWLY releases the push rod. Repeat this procedure until the fluid expelled from the bleeder hose is free of air bubbles. Remember to always

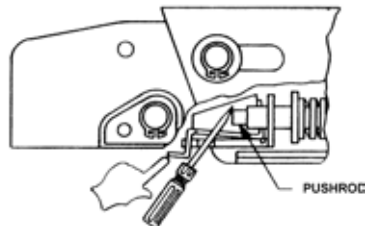
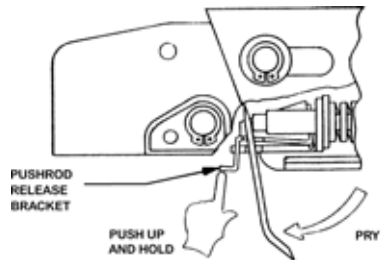

tighten the bleeder screw before releasing the push rod. During this procedure, the master cylinder reservoir fluid level must be maintained at no less than half full.

6. Repeat Steps 4 and 5 for the other brake, as well as the brakes on the front axle of tandem axles.
7. If installation is on a tandem-axle trailer, repeat the bleeding procedure on the rear axle brakes for a second time to assure purging of all air in the system.
8. As a final check after bleeding is completed, stroke the push rod and check to be sure the brake system is pressurized. This is done by attempting to rotate a tire around.
9. Push up on the safety release bracket to ensure that the push rod is in the released position.
10. After the bleeding is completed, recheck the fluid level in the master cylinder. Fill the master cylinder reservoir to the indicator on the reservoir plug. Do not overfill.



Important: Do not use brake fluid drained from the brake system to refill the master cylinder reservoir as such fluids contain contaminants from the system that may result in brake failure or costly repairs.

TRAILER JACK

MasterCraft



MasterCraft recommends using the trailer jack to lift the coupling of a loaded trailer from the hitch ball, and for moving the trailer about when it is disconnected from the towing vehicle. Rotate the trailer jack to the vertical position and engage the locking pin before placing a load on the trailer jack.

Like any mechanical assembly, the trailer jack requires maintenance to continue functioning properly. The drive gear and the rack-and-pinion should be greased, and the coaster and wheel bearings should be oiled frequently.

Failure to swing up the trailer jack before towing may result in damage to the trailer.



Failure to engage the locking pin may result in the collapse of the jack stand, which could cause serious injury or death.

TIE-DOWNS

MasterCraft

Ensuring that a MasterCraft boat will be held securely in place on the trailer's hull support, especially when underway, is extremely important. If the boat is not firmly and properly secured, the boat can be damaged as it bounces against the hull supports.

MasterCraft's Boat Buddy System is located on the winch stand. Ask an authorized MasterCraft dealer to demonstrate the proper use of the Boat Buddy System. A separate winch strap is provided and should be attached to secure the boat to the bow strap.



Also, it is very important to be sure that the transom of the MasterCraft boat is resting fully and securely on the supports provided at the rear end of the trailer, and that it remains in place when parked or underway.

Tie-downs have been added on both the bow and transom of the boat and must be used while trailering.

HITCHING UP

MasterCraft

- Hitch only to the ball size marked on the coupler.
- Be certain that the ball clamp captures the ball and lever or that the hand wheel is fully closed or tightened. Insert safety pin or optional lock pin.
- Cross the safety cables under the coupling.
- Allow only enough slack in the safety cables to handle turns. When hitching the trailer up, always observe each item on the Trailer Checklist, found in this Manual. Hitching the trailer to the tow vehicle may be performed by just one person, but it is definitely easier with a second person to help guide.

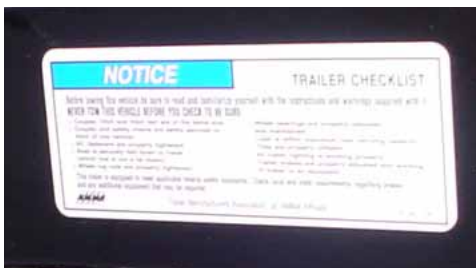

Here are the basic steps to hitch up to the trailer:

- Slowly back the tow vehicle as close as possible to the trailer. It's easier—and safer—than pulling the trailer to the car or truck.
- Check to be sure the coupler locking device is released.
- Raise the front end of the trailer with the trailer jack, position the coupler directly over the hitch ball and lower the trailer with the trailer jack until it is all the way down onto the hitch ball.
- Check under the coupling to be certain that the ball clamp is below the ball and not riding on top of the ball.
- Lock the coupler to the hitch ball. To confirm that the coupler is locked onto the hitch ball, lift up on the trailer jack. If the trailer jack comes loose from the hitch ball, unlock and go back to the third step above.
- Be certain that the trailer jack is in the fully raised and locked position.
- Attach the surge break-away cable to the tow vehicle, making sure there is enough slack for tight turns.
- Attach the safety cables.
- Connect the trailer's seven-wire connector to the seven-wire connector of the tow vehicle and check the operation of the lights.

TRAILER TIPS & TECHNIQUES

With a boat trailer in tow, an operator will be driving down the road with a vehicle combination that is longer, heavier and sometimes wider and taller than the tow vehicle. This means the operator should make a few adjustments to normal driving practices to compensate for the differences. Here are a few tips:



- **Take a shakedown cruise.**

Before making the first major trip or first trip to the lake

with a MasterCraft trailer, make at least one short trial run to become familiar with its handling characteristics. Be sure everything is working properly.

- **Slow down.** There is less strain on the tow vehicle, trailer and boat at moderate to slow speeds. Also, many states have lower speed limits for vehicles towing trailers. Driving at moderate speeds will place less strain the tow vehicle and the trailer. Trailer instability (sway) is more likely to occur as speed increases. Particular attention needs to be given to slowing when traveling over bumpy roads and railroad crossings.
- **Allow extra time and space.** You'll need more of both when passing and stopping.
- **Avoid sudden steering maneuvers.** These may create sway or undue side force on the trailer. To control swaying caused by air pressure changes and wind buffeting when larger vehicles pass from either direction, release the accelerator pedal to slow down. Keep a firm grip on the steering wheel.
- **Allow considerably more distance for stopping than you would if driving the tow vehicle without the trailer.** There is considerably more weight to be maneuvered, and even though your trailer is equipped with a braking system, it is highly likely that additional room will be needed in order to execute slowing or full stops.
- **Check the rear view mirrors.** If not already equipped with them, install outside rear view mirrors on both sides of the tow vehicle. Make it a habit to check the mirrors at frequent intervals to be sure the trailer and boat are riding properly.
- **Swing wider.** Trailer wheels are closer to the inside of turns than the wheels on the tow vehicle. This means swinging wider at curves and corners.
- **Pass with extra care.** Signal well in advance and make sure you allow extra distance to clear the vehicle you are passing before you pull back into the lane. Pass on level terrain with plenty of clearance. Avoid passing on steep up- or down-grades. Downshift as necessary to improve acceleration or speed maintenance. When passing on narrow roads be careful to avoid soft shoulders. Running on soft shoulders could cause the trailer to jack-knife or go out of control.
- **Do not attempt to control trailer sway by applying the tow vehicle brakes.** Especially avoid jamming on the brakes hard. Generally, this type of action makes the sway worsen.
- **Pay attention to wind.** Be prepared for sudden changes in air pressure and/or wind buffeting when larger vehicles pass from either direction. Slow down a little and keep a firm hand on the steering wheel.
- **Conserve fuel.** Wind resistance against the boat and trailer can reduce gas mileage significantly, especially at higher speeds.
- **Avoid sudden stops and starts.** Even though the trailer has brakes, a sudden stop can cause it to skid, slide or even jack-knife. (Be especially careful to avoid the necessity for quick stops while turning.) Smooth, gradual starts and stops will improve gas mileage and put less strain on the tie-downs, etc.

- **Signal your intentions.** Well before stopping, turning, changing lanes or passing, use turn signals to let other vehicles know what you intend to do.
- **Drive in the gear recommended by the tow-vehicle manufacturer.** If the tow vehicle has a manual transmission, traveling in lower gears when going up steep hills or over sand, gravel or dirt roads will ease the load on the engine and transmission. When driving on long downhill grades, try to avoid downshifting. Running in a low gear, which uses the engine as a brake, can actuate the trailer's surge brakes continuously for the duration of the grade, causing them to overheat. A better procedure is to slow down before the start of the down grade and maintain a controlled downhill speed with repeated application and release of tow vehicle (and thus, the trailer) brakes. This technique permits the brakes to cool down between applications and provides for reserve braking capacity in an emergency. On moderate and steep sections, downshifting into lower gears may be unavoidable. Slowing down is important to allow the brakes to avoid overheating. Don't hesitate to pull over when possible during or after severe braking situations and allow the system to cool down. Running a stretch of highway where braking is not necessary is the quickest way to cool down the brake system as it allows a significant volume of air to flow through the vented rotors and over the brake pads to cool them.
- **Always be courteous.** Make it as easy as possible for faster-moving vehicles to pass you. Remain in the slower lane and be prepared to reduce speed if they need extra time to return to the lane.
- **Do not tailgate.** Allow at least one combined car and trailer length between you and the car ahead for every 10 mph you are traveling.

If a problem occurs, the general rule is to stay calm. Do not panic and do not do anything anymore suddenly or violently than is necessary.

A sudden bumping or fan-tailing may be a flat tire. Do not jam on the brakes or mash the accelerator to try to drive out of it. Stop slowly and in as straight a line as possible. If conditions permit, allow the trailer and tow vehicle to coast at a very slow speed and try to avoid braking, except when the wheels are straight ahead and the trailer and tow vehicle are in line.

If the trailer begins to fish-tail under acceleration to highway speed, back off the accelerator a little, and it should cease. If it begins again upon acceleration, stop and check the load. If the load is not evenly distributed, or if it is too far back so that the hitch load becomes too light, the result can be fish-tailing. Re-distribute the load before continuing.

LAUNCHING

MasterCraft

Every MasterCraft boat owner develops his or her own favorite launching technique. Until you do, here are a few helpful tips:

- **Check the ramp first.** Whether launching from an unimproved or surfaced ramp, check it out before starting the launch procedure. How steep is it? Is the surface firm enough to support the weight of the trailer and tow vehicle? Is it wide enough? How deep is the water at the end of the ramp?



Use great care when walking, standing or loading and unloading boats on or around any launch ramps as some launch ramps may be slippery when wet.

- **Prepare for launching.** Install the drain plugs and detach the trailer tie-downs.
- **Slowly back the trailer down the ramp.** If possible, have someone stand to one side of the ramp to provide directions. Backing up a trailer can be tricky. A good way to simplify the procedure is to grasp the steering wheel with one hand at its lowest point (6 o'clock). To make the trailer go right, move your hand on the wheel to the right; to make the trailer go left, move your hand to the left.
- **Slowly back the trailer into the water until the trailer tire wheel well is about even with the water surface.** (This may vary with the angle of the ramp.) Set the parking brake and shift into park (automatic transmission) or first gear (manual transmission). Shut off the engine. Unlock the Boat Buddy latch and winch hook; then back the boat off the trailer.



To re-load the boat on the trailer, simply reverse the above procedures, including setting your Boat Buddy latch to the proper position, and drive the boat onto the trailer at a slow pace. Before loading, clean any dirt or sand off the rollers and bunks. Sand on these can abrade the boat's bottom while trailering. Be sure to back in and completely wet the trailer bunks, then pull forward to the loading position.

Be certain all the boat tie-downs are properly fastened down before departing from the launching ramp area. Proper loading depth on trailers will vary with conditions, but a good starting point would be the same as launch depth or slightly higher.

Helpful tip: After the launch depth has been properly determined, apply a strip of reflective tape at the water level on each guide post. That will allow launch depth to be easily repeatable.



Wet brakes may not hold and/or may cause brakes to have diminished performance characteristics. A few braking applications at a slow speed will help to dry

them out. Extra care must be used when braking after brakes have become wet.

TOWING REQUIREMENTS

States and municipalities may require special permits and licenses based on the size and weight of your trailer. Some states require additional equipment for the tow vehicle, such as side- and rear-view mirrors. Inquire at your local motor vehicle administration office to find out what requirements affect you.

If you plan to travel in another state, don't forget to check its requirements also. In addition to licenses and permits, there may be weight, height and width limits for using certain roads, bridges and tunnels. Also, be aware of restrictions regarding the transport of gases or fuels in tunnels.

And don't forget to contact your insurance company to make sure you have proper coverage for all types of towing situations. Some jurisdictions may also require liability insurance. If you have a loan for the trailer purchase, your lender may also require insurance.

TRAILERING TIPS *MasterCraft*

The trailer jack and lug wrench that came with the tow vehicle may also work on the trailer, but don't count on it! Check to make sure.

- The trailer will look better and last longer if it is rinsed off with fresh water several times a year. If the boat is run in brackish or salt water, the trailer should be rinsed thoroughly after every trip because of residual effects of the brackish or salt water. An annual washing with a mild detergent and waxing with an auto wax will also help to keep the trailer bright and clean.
- Make up a special boating kit and carry it with you on all trips. The kit should include a spare wheel and tire, lug wrench, wheel chocks, bearing grease, spare strap for tie-downs and winch, extra lights, wheel bearings and road flares.
- Some insurance policies do not provide coverage when towing a trailer. Check the policy or call the insurance agent to be certain that coverage exists.

TRAILER CHECKLIST *MasterCraft*

Before towing the vehicle be sure to read and familiarize yourself with the instructions and warnings supplied with it. **NEVER TOW THIS VEHICLE BEFORE YOU CHECK TO BE SURE:**

- Coupler, hitch and hitch ball are of the same size;
- Coupler and safety chains are safely secured to the hitch of the tow vehicle;
- All fasteners are properly tightened;
- Boat is securely tied down to trailer (*winch line is not a tie down*);
- Wheel lug nuts are properly tightened;
- Wheel bearings are properly adjusted and maintained;
- Load is within the maximum load carrying capacity;
- Load inside the boat is properly distributed;
- Tires are properly inflated;
- All trailer lighting is working properly.
- Trailer brakes are properly adjusted and working (if trailer is so equipped).
- That the tower on the boat (if so equipped) is secure, whether it is upright and locked in place or has been lowered. Also be certain that there is sufficient overhead clearance before removing the boat/trailer from cover, or when towing that the unit will clear any overhead items such as trees, bridges, overhead power lines, overpasses, etc.

This trailer is manufactured to meet the applicable federal safety standards at the time of manufacture. Check the local and state requirements regarding any additional equipment that may be required.

Note: Trailer laws covering such things as brakes, lights, safety cables, licenses, etc., will vary from state to state. Be sure that the trailer is in full compliance with applicable state laws. An authorized MasterCraft dealer can help in this regard. Otherwise, contact the nearest state motor vehicle department.

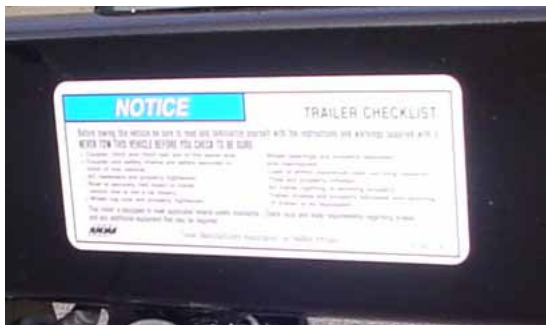

LIMITED WARRANTY STATEMENT

1. **Limited Warranty and Term.** MasterCraft Boat Company, LLC (“MasterCraft”) warrants to the original retail purchaser that the trailer shall be free from material defects in materials and workmanship to the extent set forth below, under normal use and when operated and maintained in accordance with MasterCraft’s instructions, for the period indicated:
 - 1.1 **Trailer and Trailer Component Parts.** One (1) year from the date of the original retail purchase of the trailer or the initial use of the trailer, whichever occurs first.
 - 1.2 **Axles, Hubs/VAULT System, Calipers, and Actuator.** Two (2) years from the date of the original retail purchase of the trailer or the initial use of the trailer, whichever occurs first.
 - 1.3 **Additional Warranty Period.** The axle, hub/VAULT, caliper and actuator manufacturer, UFP, may, at their discretion and within limitations established and administered only by that company, extend warranty on some components (minus labor costs). To determine the actual product and/or limitations, the consumer must contact UFP directly at 1-800-835-9211. The additional warranty period will commence with the completion of the MasterCraft administration of two (2) years, and may include none, some or all of the time period up to five (5) years from the date of the original retail purchase of the trailer or the initial use of the trailer, whichever occurs first.
2. **Warranty Conditions, Limitations and Exclusions.** MasterCraft trailers are manufactured by trained craftspersons from high-quality materials and components. However, conditions outside MasterCraft’s control require specific limitations on, and exclusions from, coverage under this warranty. The Limited Warranty constitutes the final, complete and exclusive statement of warranty terms, and no other person or entity is authorized to make any other warranties or representations on behalf of MasterCraft. Furthermore, the Limited Warranty set forth in Section 1 (including all subsections) hereof does not cover the following:
 - (a) damage caused by misuse, negligence, accident, collision or impact with any object;
 - (b) damage caused by any improper alteration or modification to the trailer or any of its component parts or accessories, including damage resulting from alteration, modification, repair or replacement that renders the trailer different from its originally manufactured condition;
 - (c) damage caused by the use of customer-applied chemicals or accidental spills;
 - (d) damage caused by failure to maintain the trailer in accordance with the maintenance provisions in the Owner’s Manual or improper maintenance of the trailer;
 - (e) damage resulting from use of the trailer for rental, commercial or industrial purposes;
 - (f) damage to hardware and other components fastened or adhered to the trailer;
 - (g) damage caused by fire, theft, freezing, vandalism, explosion, lightning, wind, hail storms, flooding or other natural disaster;



(h) damage to any component parts and accessories not manufactured by MasterCraft;

(i) damage to the trailer and its parts or components due to abrasions, rock chips, rust, improper care or maintenance, or use in salt or brackish water; however, the finishes of galvanized trailers, which are designed for use in salt or brackish water, are war-



ranted to be free from damage resulting from use in salt or brackish water for one (1) year from the date of the original retail purchase or the initial use of the trailer, whichever first occurs;

(j) damage caused by dealer-installed options or accessories;

(k) damage caused by consumer-installed options or accessories; and/or

(l) all warranted coverage will expire after ninety (90) days on trailers used for commercial purposes.

3. **Disclaimer and Limitation of Implied Warranties.** THE EXPRESS LIMITED WARRANTY SET FORTH HEREIN IS IN LIEU OF ALL OTHER WARRANTIES AND REPRESENTATIONS, EXPRESS OR IMPLIED, AND TO THE MAXIMUM EXTENT PERMITTED BY APPLICABLE LAW. MASTERCRAFT DISCLAIMS, AND THE OWNER HEREBY EXPRESSLY WAIVES, ANY AND ALL OTHER WARRANTIES OR REPRESENTATIONS OF ANY KIND OR NATURE, INCLUDING, BUT NOT LIMITED TO, IMPLIED WARRANTIES OF MERCHANTABILITY AND FITNESS FOR A PARTICULAR PURPOSE, OTHER THAN THOSE WARRANTIES WHICH ARE IMPLIED BY, AND ARE INCAPABLE OF EXCLUSION, RESTRICTION, OR MODIFICATION UNDER APPLICABLE LAW, INCLUDING, BUT NOT LIMITED TO, IMPLIED WARRANTIES OF MERCHANTABILITY AND FITNESS FOR A PARTICULAR PURPOSE, SHALL BE LIMITED TO THE DURATION OF THE FOREGOING EXPRESS WARRANTY PERIODS APPLICABLE TO THE RESPECTIVE COMPONENTS. SOME STATES DO NOT ALLOW THE EXCLUSION OF IMPLIED WARRANTIES AND/OR DO NOT ALLOW LIMITATIONS ON HOW LONG AN IMPLIED WARRANTY LASTS, SO THE ABOVE LIMITATIONS MAY NOT APPLY TO YOU. THIS LIMITED WARRANTY GIVES YOU SPECIFIC LEGAL RIGHTS. YOU MAY HAVE OTHER RIGHTS WHICH VARY FROM STATE TO STATE.

4. **Limitation of Liability.**

4.1 **Liability Limitation; Exclusion of Consequential Damages.** This warranty is for the benefit of the owner and MasterCraft, and shall not create or evidence any right to any third party. THE REPAIR OR REPLACEMENT OF DEFECTIVE COMPONENT PARTS AS PROVIDED UNDER THIS LIMITED WARRANTY IS THE EXCLUSIVE REMEDY OF THE CONSUMER. TO THE MAXIMUM EXTENT PERMITTED BY APPLICABLE LAW, IN NO EVENT SHALL MASTERCRAFT BE LIABLE FOR ANY INCIDENTAL, CONSEQUENTIAL, SPECIAL, INDIRECT, PUNITIVE OR EXEMPLARY DAMAGES OR LOST PROFITS WHATSOEVER ARISING OUT OF THE USE OR INABILITY TO USE THE BOAT OR ANY COMPONENT PART THEREOF, OR FOR ANY BREACH OF THIS WARRANTY

OR OTHERWISE, EVEN IF MASTERCRAFT HAS BEEN ADVISED OF THE POSSIBILITY OF SUCH DAMAGES OR SUCH DAMAGES COULD REASONABLY HAVE BEEN FORESEEN BY MASTERCRAFT. However, some states do not allow the exclusion or limitation of incidental or consequential damages, so the above limitation or exclusion may not apply to you.

4.2 **Purchase Price Limitation.** In any event, MasterCraft's entire liability under any provision of this Limited Warranty shall be limited to the repair or replacement of the trailer or component part, or the refund of the purchase price paid by the original retail purchaser for the trailer or component part found to be defective within the applicable warranty period. This shall constitute MasterCraft's sole liability and obligation in the event of any claim arising out of its performance or non-performance of any provision of this Limited Warranty. Because some states and jurisdictions do not allow the exclusion or limitation of liability, the above limitations may not apply to you.

5. **Transfer of Limited Warranty.** Upon the first sale, conveyance or other transfer of the trailer by the original retail purchaser, any remaining unexpired Limited Warranty coverage shall be transferred to the second owner and shall remain in effect for the remainder of the applicable warranty period set forth in Sections 1.1 through 1.3 above, provided the sale, conveyance or other transfer of the trailer by the original retail purchaser to another person or entity occurs within one (1) year of the date of the original retail purchase of the trailer by the original retail purchaser, in which event the warranty shall be transferred for the remainder of the original warranty period. If the sale, conveyance or other transfer of the trailer by the original retail purchaser occurs more than one (1) year after the date of the original retail purchase of the trailer, then the Limited Warranty shall be void as of the date of transfer and shall not be transferable to the second owner.



Only one (1) transfer under the provisions of this Section 5 (from the original retail purchaser to the second owner), within the applicable time period, may be made. In the event of a sale or transfer of the trailer by a second owner to a subsequent purchaser owner, regardless of when such sale or transfer occurs, all coverage under this Limited Warranty shall immediately be terminated and the Limited Warranty shall become null and void. No transfer of this Limited Warranty will operate to extend the warranty period set forth in Section 1 above. In order to effectuate the transfer of the Limited Warranty if available pursuant to this Section 5, the original retail purchaser and the second owner must properly fill out the warranty transfer card, which is available through Technical Services, MasterCraft Boat Company LLC, 100 Cherokee Cove, Vonore TN 37885, and deliver the completed card, together with a check made payable to "MasterCraft Boat Company, LLC" in the amount of the warranty transfer fee, via U.S. mail, postage prepaid, to MasterCraft at the address shown on the warranty transfer card. The card and check for the warranty transfer fee must be post-marked within the time period specified above in this Section 5 in order for the warranty transfer from the original retail purchaser to the second owner to be effective.

6. **Warranty Claims.** In order to maintain warranty service under this Limited Warranty, the owner must return the defective trailer or component part to an authorized MasterCraft repair facility, or to MasterCraft's factory at the below address, within the applicable warranty period. For questions regarding warranty service or to obtain information regarding the nearest authorized MasterCraft repair facility, please contact MasterCraft at the following address or telephone number:

MasterCraft Boat Company, LLC
Attention: Warranty/Customer Service Department
100 Cherokee Cove Drive
Vonore, Tennessee 37885
1-423-884-2221

Subject to the terms of this Limited Warranty, any covered trailer or component part with a material defect in the materials or workmanship that is returned to an authorized MasterCraft repair facility or MasterCraft's factory during the appropriate warranty period will be repaired or replaced, at MasterCraft's sole option, without charge to the owner for parts and labor. This provision is subject to the following terms and conditions:

- (a) MasterCraft shall be obligated only to repair or replace those items that prove defective, in MasterCraft's sole discretion, upon examination by MasterCraft's authorized repair facility or MasterCraft's own personnel, as applicable.
 - (b) MasterCraft warrants its repairs or replacements only for the remainder of the applicable warranty period.
 - (c) MasterCraft shall, in its sole discretion, fulfill its obligation to repair or replace any defective item at its factory or authorized repair facility.
 - (d) The owner shall be responsible for all costs associated with the transportation of the trailer or component part(s) to the authorized MasterCraft facility and for any return transportation.
7. **No Modification of Warranty.** No oral or written information, advice or communication of any nature by or from MasterCraft or its representatives, employees, dealers, agents, distributors or suppliers shall create a warranty or in any manner increase or modify the scope of this Limited Warranty.



(Note that failure to follow these routine procedures may result in failures that are not covered under warranty.)



WARNING

Failure to follow maintenance procedures as outlined in this Owner's Manual may result in component failure. Failure may also result in loss of control or other mal-

function that could potentially lead to serious injury or death! Such failure is not covered under warranty.

- Hose off the brake rotors and calipers, along with all other parts of the trailer that have come in contact with salt water or brackish water, as this will minimize corrosion. A fresh water flush of the system is the most critical aspect of trailer maintenance.
- Extremely thick, heavy rust on rotor surfaces will not allow the wheel assembly to rotate freely, resulting in heat build-up and premature wear on components. Clean or replace components as necessary.
- Brake pads must be replaced when $3/32"$ (.094") or less of the pad friction material is left.



WARNING

Brake pad replacement should be performed by an authorized MasterCraft dealer. Improper pad replacement may decrease braking effectiveness, potentially

resulting in a collision as a result of failure to stop the tow vehicle within an acceptable distance.

- Rotors should be resurfaced by a qualified brake specialist if extreme galling or wear marks are present.



WARNING

Worn rotors must be replaced. Failure to do so may result in brake failure, which may cause serious injury or death.

- Be certain that hydraulic fluid is clean and the fluid level is within $1/2"$ of the top of the reservoir. (See the Actuator and Axle information contained in this Owner's Manual.) Do not fill beyond that level. Brake systems use DOT 3 (preferred) or DOT 4 hydraulic fluid.
- Check for leaks in the brake lines and fittings. Leaks will lead to loss of trailer braking ability. Present the trailer to an authorized MasterCraft dealer for repair if lines or fittings appear to be leaking.
- Aluminum wheels also require attention to routine maintenance, particularly in keeping them clean. Failure to do so may result in damage that is not covered by warranty.
- The trailer and wheels should be washed weekly during boating season, and after every use if the trailer has been submerged in salt or brackish water. Use a soft brush, mild detergent and/or mild degreaser. A quality spray-on wheel cleaner may also be used. Ensure that any product used is specifically indicated for use on aluminum. (Many cleaners are too harsh and will result in pitting or other damage to the wheel surface.) Many car washes use strong chemicals and should be avoided when that is the case. Removing road film, contaminants and brake dust (all of which retain moisture) is critical to ensuring that the wheels will retain their luster and quality finish for a long period of

time. Any exposure to a hard winter climate, particularly road salt and/or chemicals, requires immediate cleaning just as submersion in salt water. NEVER CLEAN HOT WHEELS. All wheels to cool or cool them with running water. If the wheels are too hot, significant damage can occur to the wheels. It is also important to seal the wheels with a sealant that reduces static and resists brake dust. Check at an automotive supply store for an appropriate sealant.

Before Initial Use:

- Read the Owner's Manual completely.

Before Every Trip:

Ensure that all vehicle and trailer maintenance has been done as set out in the various owner's manuals.

- Verify that the tongue weight and load are within proper specification. Further, be sure that the load distribution is correct so that the tow vehicle and trailer are properly balanced front to back and side-to-side.
- Check the brake fluid reservoir to ensure it has the proper fluid level.
- Examine the brake rotor surfaces and remove excessive rust, flushing the brakes if the trailer has been idle for an extended period of time or submerged in salt water and not flushed afterwards.
- Examine the actuator for wear, bent parts, corroded/seized parts or other damage.
- Test the actuator to verify the brakes are working prior to use.
- Verify all running and brake lights, as well as turn signals and hazard lights, are working properly and that all wiring is properly connected. It must not be touching the road, but loose enough to make turns without disconnecting or damaging the wires.
- Verify the coupler latch and all equipment that connect the trailer and tow vehicle are properly secured and adjusted.
Verify that there are no leaks in the hydraulic system.
- Verify the safety cables are properly attached to the tow vehicle.
- Verify the emergency brake cable is attached properly to the tow vehicle.
- Verify the boat is properly loaded on the trailer and properly tied down to the trailer.
- Verify and/or correct tire pressure on both the tow vehicle and trailer.
- Ensure the lug nuts are properly torqued. (This must also be done after the first 25 miles of towing and every 100 miles thereafter.)
- Verify the wheel jack is retracted, up – and in the locked position prior to towing.
- Verify the tow vehicle has not exceeded the load capacity prior to towing.
- Check the guide pole bars to ensure they are tight.
Check that all items are securely fastened on and in the trailer.

Every three to six months or 250 miles, whichever occurs first (in addition to above):

- Grease the trailer jack.
- Oil the trailer jack handle in accordance with the manufacturer's recommendations.
- Examine the entire trailer for any abnormalities or damage.
- Examine the trailer bunks for any signs of abnormal wear.
- Lubricate all the rollers on the trailer with a light coat of oil.

Annually or every 2,000 miles, whichever occurs first (in addition to the above):

- To assure the bearings are in good working order, check the bearing adjustment at least once a year by following this procedure: Jack up one side of the trailer. (Be certain to use jack stands and check the trailer wheels to keep the trailer from moving during the inspection.) Grip the edge of the tire and see if it can be rocked or moved. If the outer edge of the tire moves more than 1/8", the bearings may need to be re-adjusted.

- Inspect the tow hitch for corrosion or damage. Repair or replace components as necessary.
- Check for wear on the hitch ball. The ball diameter must be in the range of 1.970"-2.00" when measured in all directions. If the ball is worn, it is UNSAFE and must be replaced.
- Check the coupler mechanism for smooth operation. If the button is hard to push or the latch handle does not spring open after being disengaged, lubricate the points on the coupler latch mechanism.
- Check the actuator for excessive wear. If the outer member is rubbing against the inner, wear marks will show on top of the coupler just forward of the outer member. Contact an authorized MasterCraft dealer for replacement parts.
- Check the actuator travel. Excessive actuator travel (over one inch) when the brakes are applied indicates air in the brake lines.
- Check the brake fluid in the master cylinder reservoir. To gain access to the reservoir, remove the cap on top of the actuator. Clean the area around the master cylinder plug. Use a screwdriver to carefully pry off the plug. Make sure the rubber seal around the opening is in good condition. Clean brake fluid off the level indicator on the plug. Re-install and remove the plug. Brake fluid should just touch the end of the level indicator.
- Check for foam or bubbles in the brake fluid. If either is present drain the fluid from the master cylinder and replace with ONLY new brake fluid of the same type (DOT 3 or 4). In order for brakes to function properly, all air must be expelled from the brake system. If bleeding is necessary, follow the manual bleeding of the brake system instructions as outlined in this Owner's Manual. It is imperative that the system be filled with only ONE type of brake fluid. Different types do not mix. Follow the instructions on the brake fluid container.
- Check the safety chains and attachment points for damage or wear. Repair or replace as necessary.
- Check the breakaway cable for worn or frayed cable strands. End fittings should be checked for damage. Replace as necessary.
- Check for any hydraulic leaks in the brake system. Be sure all tube fittings are tight. Periodic checks must be made on all hoses, brake line tubing and fittings to guard against cuts, worn hoses and loose fittings that may cause leaks in the trailer brake hydraulic system. Replace deteriorated and damaged parts as necessary.
- Check for chips and nicks in the paint. Touch up as necessary. Ignoring this will lead to accelerated wear and deterioration of the trailer.
- Check the condition of the bunks. If the coverings show wear, discuss with an authorized MasterCraft dealer. If the coverings are not in good condition or if the bunk sub-frame shows any damage this will adversely affect the fit of trailer to boat. This can result in damage to the boat hull, which is not covered under warranty.

Storage (for several months):

- If at all possible, park the boat trailer in a protected area such as a garage, carport or similar shelter.
- Have the wheel bearings checked by an authorized MasterCraft dealer prior to re-use.
- Loosen the tie-downs and winch strap, but be sure the boat is still resting properly on the hull supports.
- Remove the drain plug and elevate the trailer tongue slightly (just an inch or two) to allow water to drain out so the boat will be dry. Tie the drain plugs from the boat's bilge system to something obvious such as the steering wheel so that they will be easy to remember to re-install before the next outing.
- A good time to touch up rust spots, nicks and chips is when the trailer is in storage.
- Replace damaged tie-downs, winch straps, wiring, etc.
- Maintain proper tire inflation.
- Shield tires from UV rays.

- Relieve the load on the tires by supporting the trailer frame with concrete blocks or jack stands.
- Lubricate moving parts such as the rollers and winch, as well as the ball coupler.
- Tighten any loose nuts and bolts.

Extended storage (in excess of one year):

Follow the recommendations listed above for storage of several months duration. Additionally:

- Check the brake system for fluid level in the master cylinder. If the fluid level is low, air may be trapped in the brake lines. Bleed all lines if necessary and fill the reservoir to the proper level.
- Lubricate all links and pivots to prevent rusting.
- Fill the hub cavities (to avoid damage from vermin).
- Be certain the breakaway system has not be set and that the actuator is fully extended.
- When possible, store away from excessive moisture.

TROUBLESHOOTING *MasterCraft*



If any of the following potential problems develop, the trailer must be immediately stopped and the proper corrective action taken before the trailer is placed back in

service. Failure to do so may lead to loss of proper trailer braking capability or damage to the trailer and load.

Problem: Coupler latch handle does not open or close easily.

Possible cause:

Oversize hitch ball.

Remedy:

Check ball size at several positions. The ball should be within 1.970”-2.000” in diameter. Replace if necessary.

Possible cause:

Ball not fully inserted in the ball socket.

Remedy:

Check for the proper ball size and positive tongue load. Check to see if the tongue jack is fully retracted. Make sure there are no foreign objects or excessive point inside the coupler cavity.

Possible cause:

The trailer and tow vehicle are not level with each other or are facing downhill.

Remedy:

Reposition the tow vehicle and trailer or block a trailer tire and extend the actuator.

Possible cause:

Excessive corrosion.

Remedy:

Lubricate or replace parts as necessary.



WARNING

If the latch handle does not close freely, **DO NOT** tow the trailer until the cause of the problem is located and corrected. Forcing the latch handle closed will make

opening the latch handle extremely difficult.

Problem: Squeaking, clunking and clattering at the actuator.

Possible cause:

The hitch ball requires lubrication.

Remedy:

Lubricate with conventional multi-purpose lubricant or commercial lubricant made for hitch balls.

Possible cause:

Loose hitch ball.

Remedy:

Inspect the hitch ball and tighten.

Possible cause:

Loose hitch.

Remedy:

Inspect the hitch and repair.

Possible cause:

A worn or too small hitch ball.

Remedy:

Replace the hitch ball with a quality unit that meets SAE specifications.

Possible cause:

Worn shock absorber in the actuator.

Remedy:

Replace the shock absorber.

Possible cause:

Air in the brake lines allowing the actuator to travel too far.

Remedy:

Check for leaks and re-bleed the brakes.

Possible cause:

Trailer is equipped with "free backing brakes."

Remedy:

Clunking noise is typical for these types of brakes as long as braking performance is normal.

Problem: When braking, brakes repeatedly come on and release. Braking is not smooth, a condition called "chucking."

Possible cause:

Worn out shock absorber in actuator.

Remedy:

Replace the shock absorber.

Possible cause:

Loose hitch or hitch ball.

Remedy:

Correct as necessary.

Possible cause:

Not enough tongue weight or shocks on tow vehicle are too soft.

Remedy:

Correct as necessary.

Possible cause:

Air in the brake lines.

Remedy:

Bleed the brake lines.

Possible cause:

Brakes out of adjustment.

Remedy:

Adjust the brakes properly.

Possible cause:
Contaminated brake linings.

Remedy:
Fix the cause of the contamination, which will be a leaky wheel cylinder or hub grease seal. Replace the linings and clean the braking surface on the rotor.

Possible cause:
Corroded master cylinder bore or rust from the brake line.

Remedy:
Replace the actuator master cylinder.

Possible cause:
Breakaway cable has been pulled.

Remedy:
Reset the push rod release bracket.

Problem: Brakes do not operate or there is poor brake performance.

Possible cause:
Worn out brake shoes or disc brake pads.

Remedy:
Replace the brake shoes/pads on both sides of the axles and check the drums/rotors for wear or damage.

Possible cause:
Foreign material in the brake unit assembly.

Remedy:
Clean thoroughly. Replace the shoes and linings if contaminated.

Possible cause:
Insufficient amount of hydraulic fluid.

Remedy:
Fill the reservoir and bleed the brakes. Check for leaks.

Possible cause:
Broken lines or pinched line.

Remedy:
Replace faulty lines and bleed the brakes.

Possible cause:
Seized actuator master cylinder that prevents the piston from stroking.

Remedy:
Replace actuator master cylinder.

Possible cause:
Corrosion/rust keeps brake from operating.

Remedy:
Replace damaged components or entire brake assembly as required.

Problem: One brake is overheating.

Possible cause:
Disc brake caliper does not permit the brake pads to release.

Remedy:
Check the caliper. Sections must be free to move apart. If frozen in place, remove and free it up. Caliper piston may freeze up and prevent pads from retracting. Clean contaminants out of the piston cavity. Replace the piston, seal and protective dust cover boot. Bleed the brake system.

Possible cause:
Leaky or seized brake wheel cylinder.

Remedy:
Replace/rebuild the wheel cylinder and replace the brake shoes if contaminated with brake fluid. Clean the drums and other hardware, readjust the brakes and bleed the brake system.

Possible cause:
Damaged or frozen brake mechanism.

Remedy:
Rebuild or replace the brake unit.

Problem: More than one brake is overheating.

Isolate the problem to the actuator or the brakes by:

1. Fully extend the actuator.
2. Remove the master cylinder reservoir plug.
3. Check that the reservoir is properly filled.
4. Manually push the actuator inner member in or use a screwdriver to stroke the push rod.
5. In the first 1/8" of stroke, the reservoir fluid will either remain dead calm or swirl around. If the fluid swirls fluid is allowed to return to the reservoir when the actuator is extended. This means the actuator is functioning properly and it is necessary to troubleshoot the brakes.

Possible cause:

Trailer has been stored with the actuator compressed and rust has caused the brakes to freeze up.

Remedy:

Remove the brakes. Clean, repair or replace the components as necessary. This is best done by an authorized MasterCraft dealer.

Possible cause:

Pinched or kinked brake lines.

Remedy:

Check the brake lines and replace as necessary.

If fluid does NOT move in Step 5, it means the brake system is remaining pressurized and there is an actuator issue. Troubleshoot the actuator.

Possible cause:

Pulled breakaway cable and the push rod has not been reset.

Remedy:

Reset the breakaway cable and install the clip.

Other potential issues with the actuator include:

- the fluid return hole in the master cylinder is clogged or is not correctly positioned;
- corrosion in the master cylinder is freezing the piston or not allowing it to fully retract, which is usually caused by a trailer being stored with the actuator compressed;
- or some other malfunction or damage that is keeping the master cylinder from retracting.

These are more complex issues and should be addressed by an authorized MasterCraft dealer.



MasterCraft Boat Company
100 Cherokee Cove Drive
Vonore TN 37885
423.884.2221